

# POPULAR COMMUNICATIONS

NOVEMBER 1984 \$1.95  
\$2.50 CANADIAN

## Police Radio: It's Great To Listen In, But Is It Legal?

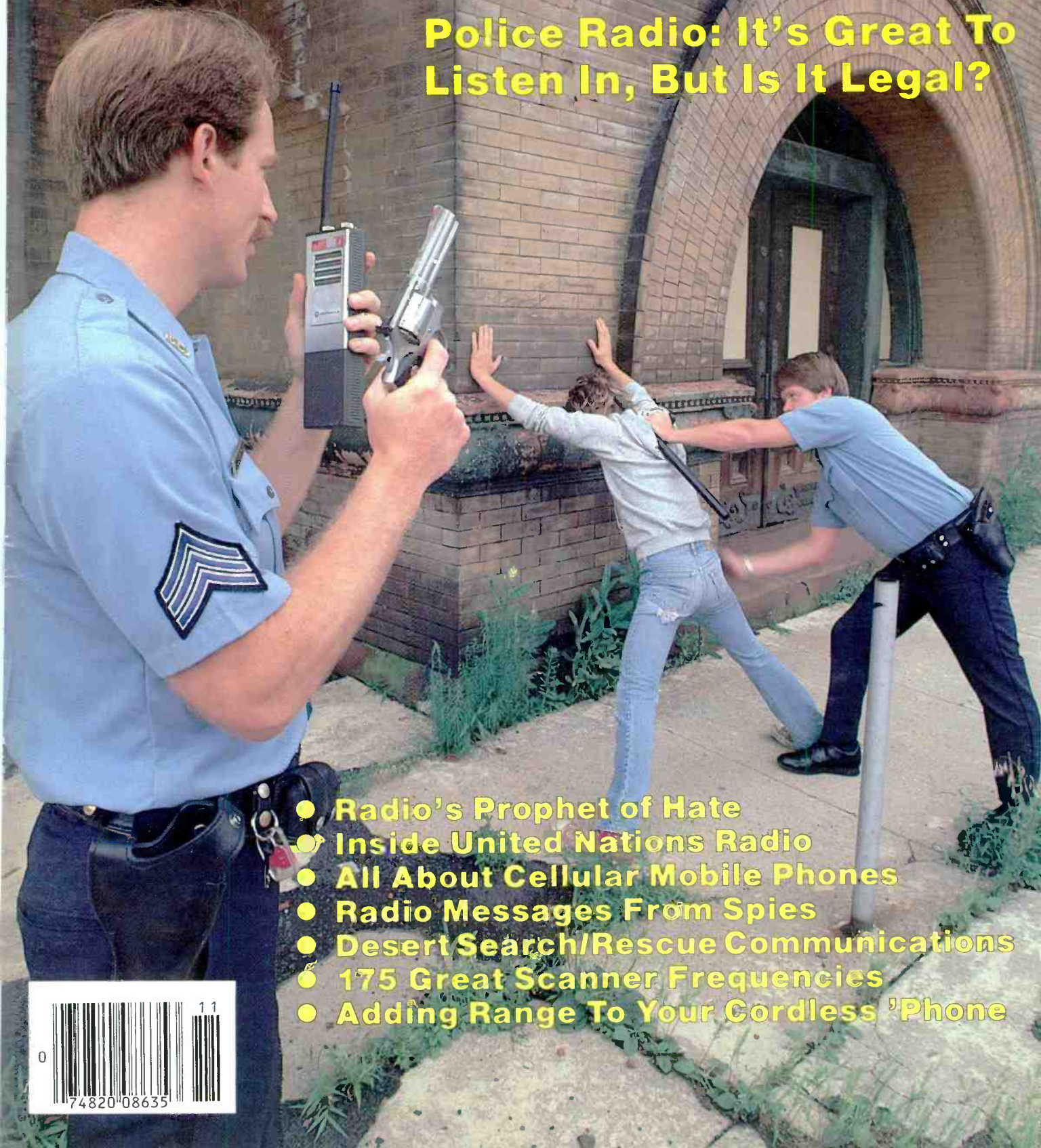

- Radio's Prophet of Hate
- Inside United Nations Radio
- All About Cellular Mobile Phones
- Radio Messages From Spies
- Desert Search/Rescue Communications
- 175 Great Scanner Frequencies
- Adding Range To Your Cordless 'Phone





# KENWOOD

pacesetter in amateur radio

## R-11 portable receiver

### R-11

Kenwood's R-11 is the perfect "go anywhere" portable receiver. It covers the standard AM and FM Broadcast bands, plus nine additional short wave bands. The R-11's selectivity is greatly enhanced by the use of double conversion on short wave frequencies above 5.95-MHz. High sensitivity coupled with a dual antenna system (telescopic and ferrite core) allow it to

reach out and bring in those distant stations from all over the world.

Simplicity of operation is enhanced by a band-spread type tuning control. Electronic band switching, with LED band indicator, along with a tuning meter to indicate received signal strength, combine to provide you with superior listening capability. Safety Hold-Release switch prevents accidental station loss. Large front mounted speaker provides excellent sound quality. Tone switch adjusts for high, low and voice transmission.

Optional HS-7 micro-head phones allow for private listening pleasure.

All this along with a record output jack, external antenna terminal and a rugged and attractive carrying case make the R-11 portable receiver the perfect travel companion!

More information on the Kenwood receivers is available from authorized dealers of Trio-Kenwood Communications 1111 West Walnut Street, Compton, CA 90220.

CIRCLE 77 ON READER SERVICE CARD



**R-2000** Top-of-the-line general coverage receiver • 150 kHz to 30 MHz • Ten memories • Dual 24-hr clock with timer • Scanning • 100-240 VAC (Opt. 13.8 VDC) • Opt. VHF (118-174 MHz converter).

**R-1000** High performance receiver • 200 kHz-30 MHz • digital display/clock/timer • 3 IF filters • PLL UP conversion • noise blanker • RF step attenuator • 120-240 VAC (Optional 13.8 VDC).

**R-600** General coverage receiver • 150 kHz-30 MHz • digital display • 2 IF filters • PLL UP conversion • noise blanker • RF attenuator • front speaker • 100-240 VAC (Optional 13.8 VDC).







# SCANNER WORLD, USA

10 New Scotland Ave., Albany, NY 12208 518/436-9606

## special The Regency D310

### 30 Channel Automatic/Programmable Scanner

#### FEATURES

- **30 Channels** For full coverage and easy selection.
- **No Crystals Required** Your choice of over 15,000 frequencies just by pushing a button.
- **6 Bands** Covers high and low VHF, UHF and UHF "T" plus two FM Ham Bands.
- **Search or Scan** Scan frequencies you have entered or search for exciting new frequencies.
- **Priority Control** Automatically overrides all other calls to listen to your favorite frequency.
- **Permanent Backup System** Memory requires no batteries. Capacitor saves frequencies entered up to one week during power outage or storage.
- **Dual Level Display** Selects brightness level of vacuum fluorescent digital display.
- **Channel Lockout** Skips channels not of current interest.
- **Scan Delay** Lets you set a delay so that replies to calls will be heard before scanning resumes.
- **Display Messages** Display flashes verbal messages to aid in programming.
- **External Speaker Jack** Standard connection allows use of external speaker.
- **AC or DC** Use at home or on the go. Both power cords included.

#### Scanner World Price

**\$129.99**

(plus 4.50 Shipping)

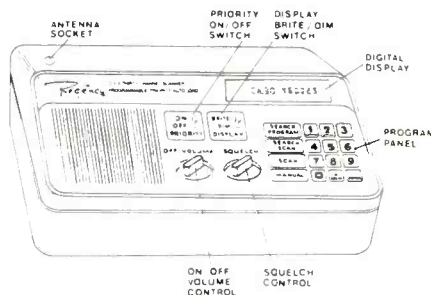

#### Suggested Factory List Price \$259.95

The Regency D310 is a compact, programmable 30 channel, multi band, FM monitor receiver for use at home or on the road. It is double conversion, superheterodyne used to receive the narrow band FM communications in the amateur, public safety and business bands: 30-50, 144-174, and 440-512 MHz.

Sophisticated microprocess-controlled circuitry eliminates the need for crystals. Instead, the frequency for each channel is programmed through the numbered keyboard similar to the one used on a telephone. A "beep" acknowledges contact each time a key is touched. The D310 scans approximately 15 channels per second.

Any combination of two to thirty channels can be scanned automatically, or the unit can be set on manual for continuous monitoring of any one channel. In addition, the search function locates unknown frequencies within a band.

Other features include scan delay, priority and a bright/dim switch to control the brightness of the 9-digit Vacuum-Fluorescent display. The D310 can be operated on either 120VAC or 12VDC. One year warranty from Regency Electronics.

- **Telescoping Antenna** Electronically optimized for all frequencies. included.
  - **External Antenna Jack** Permits maximum reception range.
  - **UL Listed/FCC Certified** Assurance of quality, American made design and manufacture.
- Optional Mobile Cigarette Lighter Plug (RGMPC... 4.95)**

#### REGENCY D310 only

**\$129.99**

(plus 4.50 Shipping)

REGENCY D-310 30 Channel Digital	129.99(4.50)
REGENCY MA-506 Carry Case for HX-650 & H-604	12.99 (*)
REGENCY ACT-R-92AP Aircraft Crystal	119.99(4.00)
REGENCY POLARIS MT-5500XL Marine	214.99(5.50)
REGENCY R1050 AC 10 Chan. Programmable	116.99(4.00)
REGENCY C403 AC 4 Channel Crystal HLU	66.99(4.00)
REGENCY Z-30 — 30 Channel Digital	172.99(4.00)
REGENCY Z-10 — 10 Channel Digital	146.99(4.00)
REGENCY MX5000 All Band Scanner	369.99(5.50)
REGENCY D100 10 Channel Digital	138.99(4.00)
REGENCY MX3000 30 Channel Digital	186.99(4.00)
RCD Listen-In	38.99(3.00)
REGENCY R106 AC/DC 10 Chan. HLU Crystal	96.99(4.00)
REGENCY D810 AC 50 Chan. HLU & Air Digit.	249.99(4.00)
JIL SX-100 16 Channel Scanner	159.99(4.00)
JIL SX-200 16 Channel Scanner	269.99(4.00)
RUSSELL Digi-10 Russian Hi/Lo Handheld	114.99(3.00)
FANON M8HLU 8 Chan. Mini Mobile Crystal	99.99(4.00)
FANON PSK-1 AC adapter for M8HLU	12.99 (*)
FANON SlimLine 6 HLU Handheld Crystal Scanner	103.99(4.00)
FANON CHB-6 Charter/AC Adapter for Slim 6	12.99 (*)
FANON CAT-6 Carrying Case with Belt Clip	11.99 (*)
FANON AUC-3 Autolighter Adapter/Charger	12.99 (*)
FANON SCMA-6 Mobile Adapter/Charger/Amplifier for Slim Line 6 HLU	38.99(3.00)
FANON PSK-6 Base Power Supply for SCMA-6	14.99 (*)
BEARCAT 350 AC/DC 50 Channel	394.99(5.50)
BEARCAT 5 HLU AC Crystal Scanner	94.99(4.00)
BEARCAT FIVE-SIX Pocket Scanner	126.99(4.00)
BEARCAT SP-55 Carry Case for BC5/6	12.99 (*)
BEARCAT BC-260 AC/DC Scanner	278.99(4.00)
BEARCAT DX-1000 Shortwave Radio	499.99(12.00)
BEARCAT 20/20 Digital Scanner	279.99(4.00)
BEARCAT 220 Digital Scanner	249.99(4.00)
BEARCAT 250 Digital Scanner	265.99(4.00)
BEARCAT 100 Digital Hand-Held	284.99(5.50)
BEARCAT 300 Digital Scanner	346.99(5.50)
BEARCAT 201 Digital Scanner	194.99(4.00)
BEARCAT 180 Digital Scanner	168.99(4.00)
BEARCAT 210 XL Digital Scanner	224.99(4.00)

BEARCAT 15 Crystal Scanner... 126.99(4.00)  
 REGENCY RH-250 High Band 2 way Radio... 479.99(5.50)  
 REGENCY Z100 watt High Band Amplifier... 209.99(4.00)  
 JIL SX-400 All Band DC Scanner... 549.99(12.00)  
 Uniden/President CB Radios - All Models in Stock  
 Fox & Whistler Radar Detectors - in Stock

#### Super Special Package Sale!

### REGENCY HX-650

#### Pocket Scanner

6 CHANNELS — 4 BANDS

VHF-Low ..... 30 to 50 MHz  
 VHF-High ..... 146 to 174 MHz  
 UHF ..... 450 to 470 MHz  
 UHF-T ..... 470 to 512 MHz  
 Small Size: .334" W x 5 1/2" H x 1" D

Quality features included in the Regency HX-650 are 6 channels - 4 band coverage, lockout switches, manual step switch, scanning speed of 15 channels per second, long lasting LED's, volume & squelch controls, AC adapter/charger jacks.

#### Scanner World's Special Package Deal

##### Includes the following:

- Regency HX-650 Pocket Scanner
- MA-506 Carry Case with metal belt clip
- Set of 4 AAA Nickel Cadmium Batteries
- 6 Monitor Crystals (specify frequencies needed or will include certificates for unknown frequencies)
- Flexible Rubber Duckey Antenna
- AC Adapter & Charger

#### Scanner World Package Price

**\$109.99**

(Plus \$5.50 Shipping)



#### Ordering Information

Call (518) 436-9606 to place orders by phone or mail orders to **Scanner World**, 10 New Scotland Ave, Albany, NY 12208. Orders will be shipped same day received by United Parcel Service. **Scanner World** accepts VISA, MasterCard. C.O.D. shipments by United Parcel will be for cash or certified checks only. Mail orders with personal or business checks will be held 4 weeks for bank clearance. Orders with cashiers checks or money orders shipped same day received. Prices, specifications and terms subject to change without prior notice. If items are out of stock we will backorder and notify you of delivery date. All shipments are F.O.B. **Scanner World** warehouse in Albany, NY. We are not responsible for typographical errors. All merchandise carries full manufacturers warranty. Bid Proposals and Purchase Orders accepted from Government agencies. Free full line catalogue available upon request. No minimum order. New York State Residents add 7% sales tax. Dealers send business letterhead for dealer wholesale information.

#### Shipping Charges

Add (\$) per scanner, and \$30.00\* for all accessories ordered at same time. C.O.D. shipments will be charged an additional \$3.00 per package. Full insurance is included in shipping charges. All orders are shipped by United Parcel Service. Shipping charges are for continental USA only. Outside of continental USA, add \$15.00 per scanner.

#### Scanner World, USA

10 New Scotland Ave, Albany, NY 12208  
 (518) 436-9606

CIRCLE 52 ON READER SERVICE CARD



# NEW!

# uniden® Bearcat®

## Products

Communications Electronics™, the world's largest distributor of radio scanners, is pleased to announce that *Bearcat* brand scanner radios have been acquired by Uniden Corporation of America. Because of this acquisition, Communications Electronics will now carry the complete line of Uniden *Bearcat* scanners, CB radios and Uniden *Bandit™* radar detectors. To celebrate this acquisition, we have special pricing on the Uniden line of electronic products.

### Bearcat® 300-E

List price \$549.95/CE price \$339.00  
**7-Band, 50 Channel • Service Search • No-crystal scanner • AM Aircraft and Public Service bands • Priority Channel • AC/DC Bands: 32-50, 118-136 AM, 144-174, 421-512 MHz.**  
 The *Bearcat 300* is the most advanced automatic scanning radio that has ever been offered to the public. The *Bearcat 300* uses a bright green fluorescent digital display, so it's ideal for mobile applications. The *Bearcat 300* now has these added features: Service Search, Display Intensity Control, Hold Search and Resume Search keys, Separate Band keys to permit lock-in/lock-out of any band for more efficient service search.

### Bearcat® 20/20-E

List price \$449.95/CE price \$269.00  
**7-Band, 40 Channel • Crystallines • Searches AM Aircraft and Public Service bands • AC/DC Priority Channel • Direct Channel Access • Delay Frequency range 32-50, 118-136 AM, 144-174, 420-512 MHz.**  
 Find an easy chair. Turn on your *Bearcat 20/20* and you're in an airplane cockpit. Listening to all the air-to-ground conversations. Maybe you'll pick up an exciting search and rescue mission on the Coast Guard channel. In a flash, you're back on the ground listening as news crews report a fast breaking story. Or hearing police and fire calls in your own neighborhood, in plenty of time so you can take precautions. You can even hear ham radio transmission, business phone calls and government intelligence agencies. Without leaving your easy chair. Because you've got a *Bearcat 20/20* right beside it.

The *Bearcat 20/20* monitors 40 frequencies from 7 bands, including aircraft. A two-position switch, located on the front panel, allows monitoring of 20 channels at a time.

### Bearcat® 210XL-E

List price \$349.95/CE price \$209.00  
**8-Band, 18 Channel • Crystallines • AC/DC Frequency range 32-50, 144-174, 421-512 MHz.**  
 The *Bearcat 210XL* scanning radio is the second generation scanner that replaces the popular *Bearcat 210* and 211. It has almost twice the scanning capacity of the *Bearcat 210* with 18 channels plus dual scanning speeds and a bright green fluorescent display. Automatic search finds new frequencies. Features scan delay, single antenna, patented track tuning and more.

### Bearcat® 260-E

List price \$399.95/CE price \$249.00  
**8-Band, 16 Channel • Priority • AC/DC Frequency range 30-50, 138-174, 406-512 MHz.**  
 Keep up with police and fire calls, ham radio operators and other transmission while you're on the road with a *Bearcat 260* scanner. Designed with police and fire department cooperation, its unique, practical shape and special two-position mounting bracket makes hump mounted or under dash installation possible in any vehicle. The *Bearcat 260* is so ruggedly built for mobile use that it meets military standard 810c, curve y for vibration rating. Incorporated in its gunged, all metal case is a specially positioned speaker delivering 3 watts of crisp, clear audio.

### NEW! Bearcat® 201-E

List price \$279.95/CE price \$179.00  
**9-Band, 16 Channel • Crystallines • AC only Priority • Scan Delay • One Key Weather Frequency range 30-50, 118-136 AM, 146-174, 420-512 MHz.**  
 The *Bearcat 201* performs any scanning function you could possibly want. With push button ease, you can program up to 16 channels for automatic monitoring. Push another button and search for new frequencies. There are no crystals to limit what you want to hear.

### NEW! Bearcat® 180-E

List price \$249.95/CE price \$149.00  
**8-Band, 16 Channel • Priority • AC only Frequency range: 30-50, 138-174, 406-512 MHz.**  
 Police and fire calls. Ham radio transmissions. Business and government undercover operations. You can hear it all on a *Bearcat 180* scanner radio. Imagine the thrill of hearing a major news event unfold even before the news organizations can report it. And the security of knowing what's happening in your neighborhood by hearing police and fire calls in time to take precautions. There's nothing like scanning to keep you in-the-know, and no better way to get scanner radio performance at a value price than with the *Bearcat 180*.

### Bearcat® 100-E

**The first no-crystal programmable handheld scanner.**  
 List price \$449.95/CE price \$234.00/SPECIAL!  
**8-Band, 16 Channel • Liquid Crystal Display Search • Limit • Hold • Lockout • AC/DC Frequency range: 30-50, 138-174, 406-512 MHz.**  
 The world's first no-crystal handheld scanner has compressed into a 3" x 7" x 1 1/4" case more scanning power than is found in many base or mobile scanners. The *Bearcat 100* has a full 16 channels with frequency coverage that includes all public service bands (Low, High, UHF and "T" bands), the 2-Meter and 70 cm. Amateur bands, plus Military and Federal Government frequencies. It has chrome-plated keys for functions that are user controlled, such as lockout, manual and automatic scan. Even search is provided, both manual and automatic. Wow...what a scanner!

The *Bearcat 100* produces audio power output of 300 milliwatts, is track-tuned and has selectivity of better than 50 dB down and sensitivity of 0.6 microvolts on VHF and 1.0 microvolts on UHF. Power consumption is kept extremely low by using a liquid crystal display and exclusive low power integrated circuits.

Included in our low CE price is a sturdy carrying case, earphone, battery charger/AC adapter, six AA ni-cad batteries and flexible antenna. The *Bearcat 100* is in stock for quick shipment, so order your scanner today.

### Bearcat® DX1000-E

List price \$649.95/CE price \$489.00  
**Frequency range 10 kHz to 30 MHz.**  
 The *Bearcat DX1000* shortwave radio makes tuning in London as easy as dialing a phone. It features PLL synthesized accuracy, two time zone 24-hour digital quartz clock and a built-in timer to wake you to your favorite shortwave station. It can be programmed to activate peripheral equipment like a tape recorder to record up to five different broadcasts, any frequency, any mode, while you are asleep or at work. It will receive AM, LSB, USB, CW and FM broadcasts.

There's never been an easier way to hear what the world has to say. With the *Bearcat DX1000* shortwave receiver, you now have direct access to the world.

### Uniden® PC22-E

List price \$159.95/CE price \$99.00  
 The *Uniden PC22* is a 40 channel AM remote mobile CB radio. It's the answer for today's smaller cars which don't always provide adequate space for mounting. Since all the controls are on the microphone, you can stash the "guts" in the trunk. The microphone has up/down channel selector, digital display, TX/RX indicator and external speaker jack. Dimensions: 5 1/2" W x 7 7/8" D x 1 1/2" H. 13.8 VDC, positive or negative ground.

### QUANTITY DISCOUNTS AVAILABLE

Order two scanners at the same time and deduct 1%, for three scanners deduct 2%, four scanners deduct 3%, five scanners deduct 4% and six or more scanners purchased at the same time earns you a 5% discount off our super low single unit price.

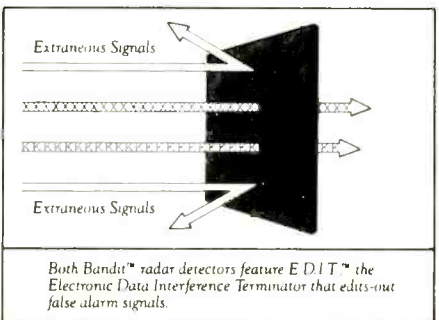

### Uniden® PC33-E

List price \$59.95/CE price \$44.00  
 The *Uniden PC33* boasts a super-compact case and front-panel mike connector to fit comfortably in today's smaller cars. Controls: Power & Volume, Squelch; Switches: ANL. Other features of the *PC33* include Graduated LED "S"/RF Meter, Digital channel indicator. Dimensions: 6" W x 6" D x 1 7/8" H. ±13.8 VDC.

### Uniden® PC55-E

List price \$89.95/CE price \$59.00  
 The full featured *Uniden PC55* front-panel mike connector makes installation easier when space is a factor. It has ANL, PA-CB, Channel 9 and RF Gain switches. LED "S"/RF meter, TX lite, PA & external speaker jacks. Dimensions: 6" W x 6" D x 1 7/8" H. ±13.8 VDC.

### Bandit™ Radar Detectors

Now that everyone else has taken their best shot at radar detection, the *Uniden Bandit™* has done them one better...with E.D.I.T.™, the Electronic Data Interference Terminator that actually edits-out false alarm signals.

The *Bandit 55*, features a convenient brightness/dimmer control for comfortable day or night driving, plus a handy highway/city control for maximum flexibility wherever you drive. The *Bandit 95 Remote*, is a two-piece modular unit that lets you mount the long-range radar antenna behind the grill, out of view. The ultra-compact control unit can then be inconspicuously tucked under the dash or clipped to the visor. Order *Bandit 55-E* for \$119.00 each or the *Bandit 95-E Remote* for \$139.00 each.

### OTHER RADIOS AND ACCESSORIES

**FB-E-E** Frequency Directory for Eastern U.S.A. .... \$12.00  
**FB-W-E** Frequency Directory for Western U.S.A. .... \$12.00  
**BC-WA-E** Bearcat Weather Alert™ ..... \$35.00  
**A60-E** Magnet mount mobile antenna ..... \$35.00  
**A70-E** Base station antenna ..... \$35.00  
 Add \$3.00 shipping for all accessories ordered at the same time.  
 Add \$3.00 shipping per scanner antenna.

### BUY WITH CONFIDENCE

To get the fastest delivery from CE of any product in this ad, send or phone your order directly to our Scanner Distribution Center™. Michigan residents please add 4% sales tax or supply your tax I.D. number. Written purchase orders are accepted from approved government agencies and most well rated firms at a 10% surcharge for net 10 billing. All sales are subject to availability, acceptance and verification. All sales on accessories are final. Prices, terms and specifications are subject to change without notice. All prices are in U.S. dollars. Out of stock items will be placed on backorder automatically unless CE is instructed differently. A \$5.00 additional handling fee will be charged for all orders with a merchandise total under \$50.00. Shipments are F.O.B. Ann Arbor, Michigan. No COD's. Most products that we sell have a manufacturer's warranty. Free copies of warranties on these products are available prior to purchase by writing to CE. International orders are invited with a \$20.00 surcharge for special handling in addition to shipping charges. Non-certified checks require bank clearance.

**Mail orders to:** Communications Electronics™, Box 1002, Ann Arbor, Michigan 48106 U.S.A. Add \$7.00 per scanner, radar detector or CB or \$12.00 per shortwave receiver for U.P.S. ground shipping and handling in the continental U.S.A. For Canada, Puerto Rico, Hawaii, Alaska, or APO/FPO delivery, shipping charges are three times continental U.S. rates. If you have a Visa or Master Card, you may call and place a credit card order. Order toll-free in the U.S. Dial 800-521-4414. In Canada, order toll-free by calling 800-221-3475. WUI Telex CE anytime, dial 671-0155. If you are outside the U.S. or in Michigan dial 313-973-8888. Order today.

Scanner Distribution Center™ and CE logos are trademarks of Communications Electronics™. Ad # 070184-E † *Bearcat* is a registered trademark of Uniden Corporation. Copyright © 1984 Communications Electronics

Order Toll Free... call  
**1-800-521-4414**

**COMMUNICATIONS  
 ELECTRONICS™**

**Consumer Products Division**

818 Phoenix □ Box 1002 □ Ann Arbor, Michigan 48106 U.S.A.  
 Call TOLL-FREE 800-521-4414 or outside U.S.A. 313-973-8888

**EDITORIAL STAFF**Tom Kneitel, K2AES  
EditorAnita Hipius  
Associate Editor**CONTRIBUTING EDITORS**Gerry L. Dexter  
Shortwave BroadcastJoseph E. Jesson  
RTTY MonitoringR.L. Slattery  
Survivalist CommunicationsRon Ricketts, WA5VFA  
Utility CommunicationsDarren Leno, WD0EWJ  
Alternative RadioHarold A. Ort, Jr.  
Military ConsultantJanice Lee  
Radar DetectorsChuck Gysi, N2DUP  
ScannersFrank Baylin  
Satellite TVGordon West, WB6NOA  
Telephone AccessoriesMark J. Manucy, W3GMG  
AM/FM Broadcasts**BUSINESS STAFF**  
Richard A. Ross, K2MGA

Publisher

Herb Pressman, KA2UGV  
Advertising ManagerArnold Sposato, KA2TYA  
Advertising RepresentativeDorothy Kehrwieider  
General ManagerAnthony C. Sparacino  
Newsstand Sales DirectorArlene Caggiano  
AccountingCheryl Chomicki  
Subscriber Services**PRODUCTION STAFF**  
Elizabeth Ryan

Art Director

Dorothy Kehrwieider  
Production ManagerGail M. Schieber  
Production AssistantPat Le Blanc  
PhototypographerHal Keith  
Technical IllustratorLarry Mulvehill, WB2ZPI  
Contributing Photographer

# POPULAR COMMUNICATIONS

NOVEMBER 1984

VOL. 3, NO.3

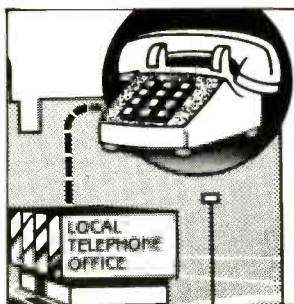

8



20

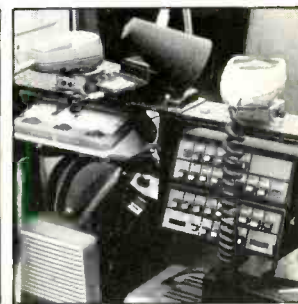

56

## FEATURES

### All About Cellular Mobile Telephones

8

In fact, more than you ever wanted to know! Here's the inside story on the new two-way communications service you've been hearing about.

by Gordon West, WB6NOA

### Radio's Prophet of Hate

14

Broadcasting had made him the second most popular and powerful man in the nation—just before it sent Father Coughlin into obscurity!

by Tom Kneitel, K2AES

### "SPY Numbers" Transmissions

20

Some recent discoveries have shed new light on these mystery signals. Here's a probing report which delves deeper into the subject, based on this latest information.

by Robert M. Dyquetta

### COVER STORY: Police Radio — A Scanner Favorite!

26

From routine license plate checks to major crimes, hear it all on a scanner—BUT there are legal and ethical questions which have been around for about 60 years!

by Rick Maslau, KNY2GL

### Selected English Language Broadcasts: Fall Skeds

32

These are your best bets for shortwave broadcast listening during the autumn and early winter.

by Gerry L. Dexter

### United Nations Radio

34

Perhaps you've heard this major international broadcasting voice. But did you know it doesn't own any broadcast transmitting facilities? Here's their unusual story.

by Gerry L. Dexter

### Books You'll Like

37

Our staff selects some useful titles for POP'COMM readers.

### 175 Great Scanner Frequencies

38

If you haven't tried these, now's the time to start. Nothing too far out—just a handy guide to a lot of interesting frequencies to scan when you're looking for new worlds to explore.

by Alice Brannigan

### Product Spotlight: Principles of Voice Scrambling

50

Controlonics, a leader in the field, has developed some extremely clever techniques.

### Emergency Search/Rescue Communications In The Desert

56

A close-up look at the inner working of an active SAR group.

by Brian M. Johnson, III

*This month's cover: Photo by Larry Mulvehill, WB2ZPI. Special thanks to the Middletown, New York Police Department.*

## DEPARTMENTS

Beaming In . . . . .	4	Survival . . . . .	56
Mailbag . . . . .	6	Communications Confidential . . . . .	60
POP'COMM Products . . . . .	19	On The Line . . . . .	64
Broadcast Topix . . . . .	40	Washington Pulse . . . . .	66
Radar Reflections . . . . .	44	Scanner Scene . . . . .	68
Satellite View . . . . .	46	Listening Post . . . . .	70
RTTY Monitoring . . . . .	52	Communications Shop . . . . .	75
Pirates Den . . . . .	54		

Offices: 76 North Broadway, Hicksville, NY 11801. Telephone 516 681-2922. Popular Communications (ISSN 0733-3315) is published monthly by Popular Communications, Inc. Corporate officers: Richard A. Ross, Pres.; Thomas S. Kneitel, Vice Pres.; Alan M. Dorhoff, Secretary. Second class postage paid at Hicksville, NY and additional offices. Subscription prices: Domestic—one year \$14.00, two years \$25.00, three years \$36.00. Canada/Mexico—one year \$16.00, two years \$29.00, three years \$42.00. Foreign—one year \$18.00, two years \$33.00, three years \$48.00. Foreign Air Mail—one year \$71.00, two years \$139.00, three years \$207.00. Entire contents copyright ©1984 by Popular Communications, Inc. Popular Communications assumes no responsibility for unsolicited manuscripts, photographs, or drawings. Allow six weeks for change of address or delivery of first issue. Printed in the United States of America.  
Postmaster: Please send change of address to Popular Communications, 76 North Broadway, Hicksville, NY 11801.



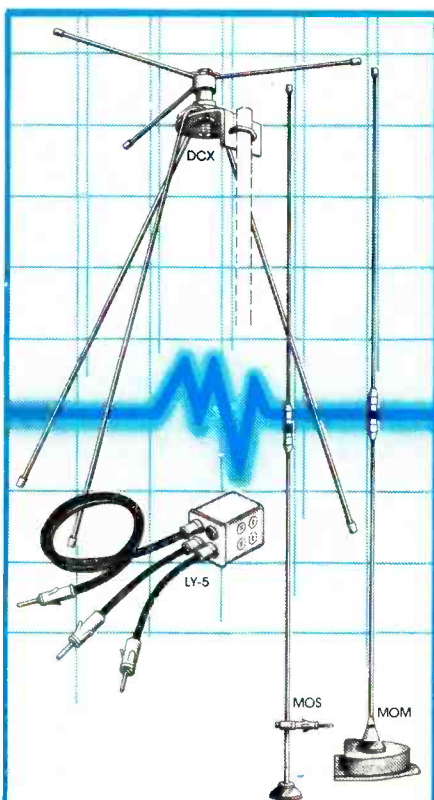

## HUSTLER Monitor Antennas Bring In All Of The Action

If you aren't using a Hustler Monitor Antenna, you're missing the action!

With a Hustler Discone or Mobile Tri-Band monitor antenna, your scanner will bring in every band — clearly and quietly from greater distances. And every Hustler monitor antenna meets the highest standards of quality and engineering in the industry — our own.

Our vertically-polarized DCX Discone Model covers all public service frequencies from 40 - 700 MHz. And, its unique coilless design minimizes signal loss.

Hustler's popular Monitor Match™ utilizes your car's antenna for up to five different bands. And, Hustler Tri-Band mobile antennas offer you more mounting configurations, plus the reliability of top-grade components throughout every model.

Don't miss any of the excitement. Bring it all in with a Hustler — Still the standard of performance.



3275 North "B" Avenue  
Kissimmee, Florida 32741

An AMPLIFICATION Company

# BEAMING IN

## AN EDITORIAL

BY TOM KNEITEL, K2AES

Scanner owners really ought to take a few lessons from communications receiver owners and become far more adventuresome than they seem to be. From my incoming mail and from conversations with scanner owners, it seems that there is a basic pattern common to the majority of listeners. They find out their area police and fire frequencies, punch them up on the microprocessors, and then devote most of their efforts to monitoring these frequencies plus a couple of others. With the exception of scanner owners located in larger metropolitan areas, many listening enthusiasts don't even have enough stations programmed into their equipment to take advantage of all 50 potential channels available to many modern scanners.

In the old days, when scanners had 8 or 16 channels, and one had to spring for \$5 to \$8 per plug-in crystal for each channel to be monitored, the battle cry was for more channels and less money for crystals. As a result, there are now 50 channels, and base station scanners don't require any crystals. Scanners are moving into new vistas (such as covering frequencies never before available) and I don't think that everybody has caught up with the last state of upgrading—50 channels, no crystals!

Communications receiver owners would not think of monitoring only a dozen or so especially favorite stations, no matter how interesting they may be. It's a hobby that cries out for almost constant exploring of new frequencies to unearth some new discovery.

Full use of a person's investment in their scanner would seem to call to erecting a decent outside antenna capable of bringing in stations other than locals. Most communications shops sell scanner antennas; even 2 and 6 meter band ham antennas do well on the high and low VHF bands, and ham antennas for the 440 MHz ham band can be put to good use on the UHF/UHF-T band.

Next, pry yourself away from those few local police/fire channels you've been hanging around for so long. Get adventuresome! Try to find out how efficient your scanner installation is and how adept you are at the art of tuning. Check out frequencies used by mobile units to see if you can hear them directly instead of as they are repeated through the base stations. Listen on base station frequencies used by police and fire dispatchers in adjacent cities, counties, and states—and when you've logged all of those, then try reaching out even further. Don't forget that the 30 to 50 MHz (VHF low band) can bring in skip stations (when conditions are right) that will tune you in on com-

munications across the nation and even overseas.

Next, punch into your scanner police and fire frequencies that don't seem to be authorized for any stations in your general area; you never know what they might present for your monitoring enjoyment. When you've done that, take a listen on industrial, maritime, mobile telephone, federal, aero, hospital/ambulance, transportation, fish/game, or forestry frequencies.

Don't be afraid to put your scanner into the search mode from time to time. For starters, punch up 155 to 156 MHz. That will be sure to bring in some near/far stations you may have never before monitored.

Reorient your thinking too. In the past you may have been viewing your monitoring efforts as something that would put you behind-the-scenes on the activities of your local police/fire agencies, the sheriff, and perhaps your local airport. Now start thinking of expanding your horizons along the lines of DX and seeing how many stations you can hear, how far you can reach out, how many interesting and unusual agencies or companies you can tune. You are not especially interested in the content of the transmissions in this mode; you are primarily interested in the fact that you are able to pick up the transmissions. You can, of course, always switch back to your first love of monitoring—your local public safety agencies—but there's no need to limit yourself to those stations.

Keep a log of what you're hearing. You don't have to have a written record of each and every peep that your scanner produces, but do keep a record of your more interesting and unusual catches, even the dozens of "unidentifieds" you'll certainly hear. A written record will help you to eventually identify such stations.

You've got an investment in your equipment; you really owe it to yourself to get the most out of your investment. Shake off the strange and unexplained restraints that seem to shackle many scanner owners. Live it up! Explore! Make the most you can from the little box with the flashing red lights.

What with the winter months approaching, you'll probably be doing a lot less of your normal outdoor activities. Now's a good time to start planning some scanner self-challenges while you're waiting out the season. Be sure to keep POP'COMM informed of what you're hearing.

(Continued on page 74)

# Make Your Commodore Radio Active

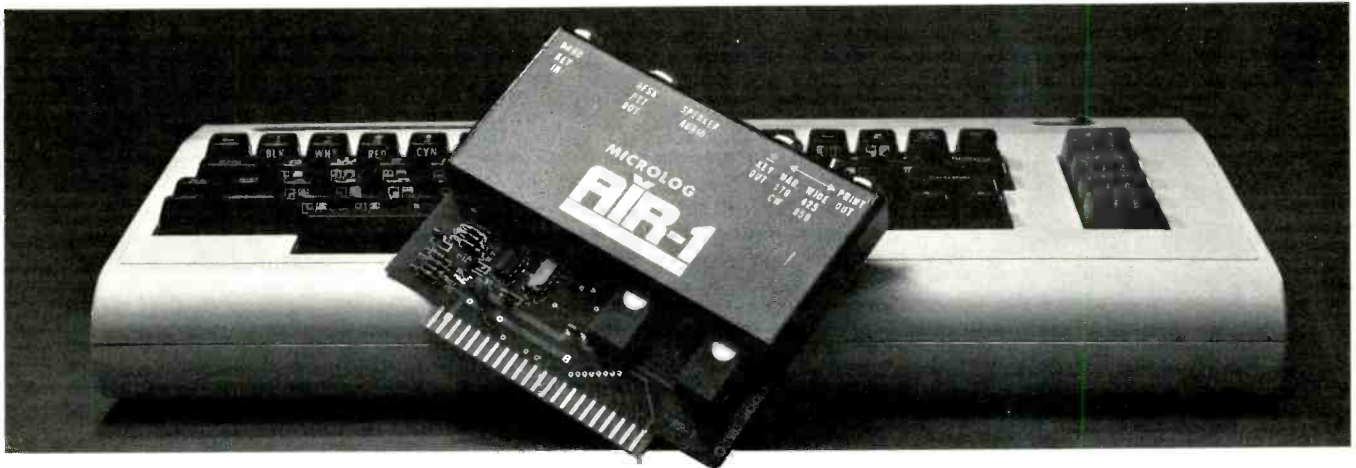

The MICROLOG AIR-1 cartridge will turn your VIC-20 or C-64 into a complete Radio Teletype and Morse code terminal. Connect a shortwave radio and you'll be watching text readout from weather stations, news services, ships and HAM radio operators all over the world. A whole new use for your home computer. The AIR-1 contains both program in ROM and radio interface circuit to copy Morse code and all speeds and shifts of radio teletype. Plus the on screen tuning indicators mean you never have to take your eyes off the video for perfect tuning.

For Ham radio use, the Air-1 will also send and receive RTTY/CW with AFSK/PTT &  $\pm$  CW keying outputs.

The AIR-1 will even tell you what Morse speed you're copying and provide built-in send/receive code practice!

With keyword or manual printer control for permanent paper copy, you won't miss a single bit of the action.

If you've been looking for something to spice-up your computing, try the ultimate "peripheral" and connect your computer to the AIR-1.

The complete AIR-1 for the VIC-20 or "64" is \$199. (With 4 mode AMTOR, \$279.) See it at your local dealer or call Microlog Corporation, 18713 Mooney Drive, Gaithersburg, Maryland 20879.

TEL: (301) 258-8400. Telex: 908153.

## MICROLOG

INNOVATORS IN DIGITAL COMMUNICATION

CIRCLE 52 ON READER SERVICE CARD

## PORTABLE ANTENNA

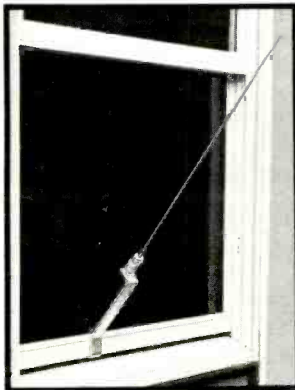

SHORTWAVE LISTENING

MODEL ASW-5

Designed for  
APARTMENTS  
MOTELS  
VACATIONS

PRICE  
\$ 39.50

Add \$2.00  
Shipping and Handling

The turn of a thumbscrew will install and remove this sturdy antenna and give you outdoor reception where conventional antennas are restricted. This window-mount antenna extends from 22 inches to 58 inches to provide coverage from 5 MHz to 100 MHz. Its 10 ft long coaxial cable connects to your shortwave or scanner receiver.

Write for more details and other B&W products



ALL OUR PRODUCTS MADE IN USA  
**BARKER & WILLIAMSON**

Quality Communication Products Since 1932  
At your Distributors. Write or call.  
10 Canal Street, Bristol, PA 19007  
(215) 788-5581



Please send all reader inquiries directly.

THE MONITORING MAGAZINE

## NEW LISTENING ADVENTURES



HEAR MORE THAN EVER BEFORE WITH THE  
NEW M-600A MULTI-MODE DECODER

Simple connections to your shortwave receiver and video monitor or printer will let you monitor thousands of Morse and Radioteletype signals in Marine, Commercial, Government, Military and Press Services. Converts standard CW and RTTY plus low and high speed ASCII, non-standard shift RTTY, Bit-Inverted RTTY and TOR (Telex Over Radio -FEC & ARQ). Isolated loop MIL-188 or RS232 provided; optional parallel printer port available.

CONTACT US FOR DETAILED INFORMATION

Phone: 614 866-4267  
MC & VISA Accepted

UNIVERSAL SHORTWAVE RADIO

1280 Aida Drive, Reynoldsburg, Ohio 43068

Please send all reader inquiries directly.

November 1984 / POPULAR COMMUNICATIONS / 5



# MAILBAG LETTERS TO THE EDITOR

The most interesting questions we receive will be answered here in each issue. Address your questions to: Tom Kneitel, Editor, Popular Communications magazine, 76 North Broadway, Hicksville, NY 11801.

## Elvira, Is That You?

One of my favorite musical groups is The Oak Ridge Boys. In a recent TV documentary about this group, they showed the bus used during the tours. A transceiver was shown in this vehicle and I was wondering how I can find out the frequency used.

Bobby Collins, KTN4KB  
Knoxville, TN

*What you saw may well have been a CB rig used for monitoring Channel 19 while in transit. However the group also has a UHF base station in Hendersonville, Tennessee on 464.225 MHz (WYN695). That would have only local coverage, although the bus may also be equipped for communicating with that station — Editor.*

## Weather Or Not

POP'COMM has given the schedules and frequencies of all manner of maritime and aeronautical weather reports and forecasts being sent out by voice, CW, RTTY, and FAX. Are there weather broadcasts sent out for reception in conjunction with personal computers? If there aren't, there should be.

Cal Wallace  
Big Spring, TX

*So far as we can find out, there is only one weather service designed for the owner of a personal computer in operation, but others may be on the way. The service, which is offered by the University of Maryland, provides detailed marine weather for any of 32 high seas or offshore forecasts (local or extended) for waters on the East Coast. With the exception of the cost of the 'phone call to the computer, there's no cost to access this information. In order to receive the information, a computer has to be set up to Baud 300, Bits 8, Parity N, and Stops 1 (these are standard settings for a number of computers). The computer's 'phone number is 1-301-820-8690. When it answers, it requests an ID (YY) plus a password (JOHNM). Forecasts are called up by the user typing in ENTER REQUEST plus the number 7000, which brings up a series of menus permitting the selection of specific area data. The forecasts are updated every six hours from NOAA offices. — Editor*

## Uncommon Carriers

It occurs to me that naval aircraft carriers are really the same as floating airports. That makes me think that they must also have their own communications facilities which are similar to an airport—like control tower, homing beacon, GCA, etc. Is there a stand-

ard frequency used for the landing operations between pilot and control tower?

T. U. Balcain  
Seattle, WA

*Modern systems have data links between the aircraft and an automatic carrier landing system on the ship. These data links allow the pilot to sit by and watch as the plane is landed by remote control. Two-way voice frequencies popularly used for air traffic control by the Navy are 340.2 and 360.2 MHz. — Editor*

## Calling All Readers

I would like very much to get in touch with others interested in (or addicted to) finding strange and wonderful things to do with telephones (phone phreaks). I will try to answer all letters.

Sheila Shigley  
221 E. Buff  
Madison, WI 53704

I am in need of a manual for a Hallicrafters S-53A receiver. Can anyone help me out?

E. Broholm  
Rt. 1 Box 612C  
Havana, FL 32333

I'd be interested in hearing from any POP'COMM reader who might be interested in corresponding by tape or letter. My interests include DXing, shortwave, ham bands (including VHF), aero/police/fire/rescue/military communications (will swap frequencies). Also interested in antennas. Please let me hear from you.

Bobby Raymer  
Route 11 Box 139  
Cookeville, TN 38501

If readers wish, I'll be happy to send them a copy of a code that has been used with good results. It's pretty hairy to crack and it has been used very successfully. Anybody who wants a copy, just send me a self-addressed, stamped (U.S. stamps only) envelope to mail it back to you.

Rick Lane  
c/o KQIP Radio  
1011 Texas Commerce Bank  
Odessa, TX 79761

*How 'bout it readers. Here are some interesting folks whom you might want to contact. We will continue to publish similar contact requests as they are received. — Editor*

## Strictly Secret

In several recent issues of POP'COMM you have presented information relating to monitoring the hostilities in the Middle East. These articles have been most accurate and you are to be commended. There has been one area of monitoring which has not been touched upon and that is the two-way mobile communications used by United Nations personnel. I assume that this has not been covered because of the tight security lid clamped on this information by the United Nations. Perhaps you could set about trying

to find out these frequencies. Photos of U.N. vehicles, which have been shown in the news media, reveal VHF low-band whip antennas.

David Ellis  
Haifa, Israel

*You were right in noting that there's a security lid on the information, however the U.N. has used the following channels in the Middle East: 40.86, 44.88, 44.94, 45.00, 45.12, and 46.90 MHz. Don't tell anyone. — Editor*

## Hide In Plain Sight

I've been on the Metroliner train between New York and Washington, DC and I know that it is equipped with telephones that passengers can use to place calls. The problem is that I've tried looking for the frequency used for this in both the 152 and 454 MHz mobile telephone bands and haven't been able to hear these calls. Are they operating on a special frequency?

M. E. Cooper, Sr.  
Washington, DC

*Yes, the Metroliner uses special federal frequencies for its telephone calls. They are as follows, with the areas of usage:*

416.125 MHz MD, NJ  
416.175 MHz DE, NJ, PA  
416.225 MHz DE, NJ  
416.875 MHz DE, NJ, NY, PA  
416.925 MHz MD, NJ  
416.975 MHz MD, NJ, PA

## Chairman Of The Bored

Several times I've witnessed "Ol' Blue Eyes" and his entourage arrive here in Las Vegas, complete with hand-held transceivers. I'd really like to be able to listen in on their communications and once asked a member of the retinue for the frequency. He wouldn't tell me (I don't think he knew what I was talking about). I'd still like to tune in.

R. D. Mortenson  
Las Vegas, NV

*Hey, R. D., sounds like really exciting listening! The Chairman's company has a license on 154.60 MHz under the callsign KC-8288. Twenty low-power portable units are authorized. Scooby-doo-by-doo and over to you! — Editor*

## Help Wanted

I have a military "communications central" unit called the AN/MS-37 which appears to be complete. The problem is I cannot locate the manual that goes along with this set. I believe the number is TM11-5895-334-10. I've tried a number of surplus dealers and companies that sell manuals. No success at all! If any POP'COMM reader could direct me to a source for this publication, it would be greatly appreciated.

Lucien Morris  
1719 Harrodsburg Rd.  
Lawrenceburg, KY 40342



# NEW!

## Regency<sup>®</sup> Scanners

Communications Electronics,<sup>™</sup> the world's largest distributor of radio scanners, introduces new models with special savings on all radio scanners. Chances are the police, fire and weather emergencies you'll read about in tomorrow's paper are coming through on a scanner today.

We give you excellent service because CE distributes more scanners worldwide than anyone else. Our warehouse facilities are equipped to process thousands of scanner orders every week. We also export scanners to over 300 countries and military installations. Almost all items are in stock for quick shipment, so if you're a person who prefers fact to fantasy and who needs to know what's really happening around you, order your radio today from CE.

### NEW! Regency<sup>®</sup> MX5000-E

List price \$599.95/CE price \$359.00  
**Multi-Band, 20 Channel • No-crystal scanner**  
**Search • Lockout • Priority • AC/DC Selectable AM-FM modes • LCD display**  
**World's first continuous coverage scanner**  
Frequency range: 25-550 MHz, continuous coverage. Never before have so many features come in such a small package. The Regency MX5000 mobile or home scanner has continuous coverage from 25 to 550 MHz. That means you can hear CB, Television audio, FM broadcast stations, all aircraft bands including military and the normal scanner bands, all on your choice of 20 programmable channels.

### Regency<sup>®</sup> MX3000-E

List price \$319.95/CE price \$179.00  
**6-Band, 30 Channel • No-crystal scanner**  
**Search • Lockout • Priority • AC/DC**  
Bands: 30-50, 144-174, 440-512 MHz.  
The Regency Touch MX3000 provides the ease of computer controlled, touch-entry programming in a compact-sized scanner for use at home or on the road. Enter your favorite public service frequencies by simply touching the numbered pressure pads. You'll even hear a "beep" tone that lets you know you've made contact.

In addition to scanning the programmed channels, the MX3000 has the ability to search through as much as an entire band for an active frequency. The MX3000 includes channel 1 priority, dual scan speeds, scan or search delay and a brightness switch for day or night operation.

### Regency<sup>®</sup> Z30-E

List price \$279.95/CE price \$169.00  
**6-Band, 30 Channel • No-crystal scanner**  
Bands: 30-50, 144-174, 440-512 MHz.  
Cover your choice of over 15,000 frequencies on 30 channels at the touch of your finger.

### Regency<sup>®</sup> C403-E

List price \$99.95/CE price \$59.00  
**5-Band, 4 Channel • Crystal scanner**  
**Channel indicator LED • AC only • Low cost**  
Bands: 30-50, 148-174, 450-470 MHz.  
Regency's basic scanner, the C403 gives you the excitement of police, fire and emergency calls at a budget price. It can tune in to any of five public service bands and brings the signal in loud and clear...on any of four possible channels. It comes with detachable telescope antenna and AC power cord. Order one crystal certificate for each channel you want to receive.

### Regency<sup>®</sup> HX1000-E

List price \$329.95/CE price \$209.00  
**6-Band, 30 Channel • No Crystal scanner**  
**Search • Lockout • Priority • Scan delay**  
**Sidelit liquid crystal display • Digital Clock**  
Frequency range: 30-50, 144-174, 440-512 MHz.  
The new handheld Regency HX1000 scanner is fully keyboard programmable for the ultimate in versatility. You can scan up to 30 channels at the same time. When you activate the priority control, you automatically override all other calls to listen to your favorite frequency. The LCD display is even sidelit for night use. A die-cast aluminum chassis makes this the most rugged and durable hand-held scanner available. There is even a backup lithium battery to maintain memory for two years. Includes wall charger, carrying case, belt clip, flexible antenna and nicad battery. Order your Regency HX1000 now.

### Regency<sup>®</sup> R106-E

List price \$159.95/CE price \$92.00  
**5-Band, 10 Channel • Crystal scanner • AC/DC**  
Frequency range: 30-50, 146-174, 450-512 MHz.  
A versatile scanner, The Regency R-106 is built to provide maximum reception at home or on the road. Rugged cabinet protects the advanced design circuitry allowing you years of dependable listening.

### NEW! Regency<sup>®</sup> R1050-E

List price \$179.95/CE price \$109.00  
**6-Band, 10 Channel • Crystalless • AC only**  
Frequency range: 30-50, 144-174, 440-512 MHz.  
Now you can enjoy computerized scanner versatility at a price that's less than some crystal units. The Regency R1050 lets you in on all the action of police, fire, weather, and emergency calls. You'll even hear mobile telephones.

Programming the R1050 is easy. Merely touch the keyboard and enter any of over 15,000 frequencies on your choice of 10 channels.

### Regency<sup>®</sup> HX650-E

List price \$129.95/CE price \$79.00  
**5-Band, 6 Channel • Handheld crystal scanner**  
Bands: 30-50, 146-174, 450-512 MHz.  
Now you can tune in any emergency around town, from wherever you are, the second it happens. Advanced circuitry gives you the world's smallest scanner. Our low CE price includes battery charger/A.C. adapter.

### NEW! Regency<sup>®</sup> HX-650P-E

List Price \$189.95/CE price \$104.00  
Now, Communications Electronics offers a special packaged price on the Regency HX-650 scanner and the following items for only \$104.00. You get the Regency HX-650 scanner, a set of 4 AAA ni-cad batteries, the MA-506 carrying case, six crystal certificates, AC adapter/charger and flexible rubber antenna for only \$104.00 per package plus \$10.00 shipping/handling. To order this special package, use CE special order number HX-650P-E.

### QUANTITY DISCOUNTS AVAILABLE

Order two scanners at the same time and deduct 1%, for three scanners deduct 2%, four scanners deduct 3%, five scanners deduct 4% and six or more scanners purchased at the same time earns you a 5% discount off our super low single unit price.

### NEW! Regency<sup>®</sup> MX7000-E

List price \$699.95/CE price \$449.00  
**10-Band, 20 Channel • Crystalless • AC/DC**  
Frequency range: 25-550 MHz, continuous coverage and 800 MHz, to 1.2 GHz, continuous coverage.  
In addition to normal scanner listening, the MX7000 offers CB, VHF, and UHF TV audio, FM Broadcast, all aircraft bands (civil and military), 800 MHz communications, cellular telephone, and when connected to a printer or CRT, satellite weather pictures.

The Regency Touch MX7000 provides the ease of computer controlled, touch-entry programming in a compact-sized scanner for use at home or on the road. Enter your favorite frequencies by simply touching the numbered pressure pads. You'll even hear a "beep" tone that lets you know you've made contact.

In addition to scanning the programmed channels, the MX7000 has the ability to search through as much as an entire band for an active frequency. When a call is received, the frequency will appear on the digital display.

### Regency<sup>®</sup> Z10-E

List price \$239.95/CE price \$138.00  
**6-Band, 10 Channel • No-crystal scanner**  
**Priority control • Search/Scan • AC/DC**  
Bands: 30-50, 140-174, 440-512 MHz.  
Cover your choice of over 15,000 frequencies on 10 channels at the touch of your finger.

### OTHER RADIO ACCESSORIES

B-4-E 1.2 V AAA Ni-Cad batteries (set of four) ..... \$9.00  
A-135C-E Crystal certificate ..... \$3.00  
A60-E Magnet mount mobile antenna ..... \$35.00  
A70-E Base station antenna ..... \$35.00  
Add \$3.00 shipping for all accessories ordered at the same time.  
Add \$3.00 shipping per scanner antenna.

### BUY WITH CONFIDENCE

To get the fastest delivery from CE of any scanner, send or phone your order directly to our Scanner Distribution Center.<sup>™</sup> Be sure to calculate your price using the CE prices in this ad. Michigan residents please add 4% sales tax or supply your tax I.D. number. Written purchase orders are accepted from approved government agencies and most well rated firms at a 10% surcharge for net 10 billing. All sales are subject to availability, acceptance and verification. All sales on accessories are final. Prices, terms and specifications are subject to change without notice. All prices are in U.S. dollars. Out of stock items will be placed on backorder automatically unless CE is instructed differently. A \$5.00 additional handling fee will be charged for all orders with a merchandise total under \$50.00. Shipments are F.O.B. Ann Arbor, Michigan. No COD's. Most products that we sell have a manufacturer's warranty. Free copies of warranties on these products are available prior to purchase by writing to CE. International orders are invited with a \$20.00 surcharge for special handling in addition to shipping charges. Non-certified checks require bank clearance.

Mail orders to: Communications Electronics,<sup>™</sup> Box 1002, Ann Arbor, Michigan 48106 U.S.A. Add \$7.00 per scanner for U.P.S. ground shipping and handling in the continental U.S.A. For Canada, Puerto Rico, Hawaii, Alaska, or APO/FPO delivery, shipping charges are three times continental U.S. rates. If you have a Visa or Master Card, you may call and place a credit card order. Order toll-free in the U.S. Dial 800-521-4414. In Canada, order toll-free by calling 800-221-3475. WUI Telex CE anytime, dial 671-0155. If you are outside the U.S. or in Michigan dial 313-973-8888. Order today.

Scanner Distribution Center<sup>™</sup> and CE logos are trademarks of Communications Electronics Inc.  
†Regency is a federally registered trademark of Regency Electronics Inc. AD #080384-E  
Copyright © 1984 Communications Electronics

## Order Toll Free... call 1-800-521-4414

# COMMUNICATIONS ELECTRONICS<sup>™</sup>

### Consumer Products Division

818 Phoenix □ Box 1002 □ Ann Arbor, Michigan 48106 U.S.A.  
Call TOLL-FREE 800-521-4414 or outside U.S.A. 313-973-8888

CIRCLE 37 ON READER SERVICE CARD

Regency  
MX3000

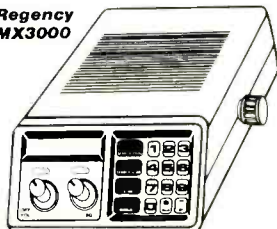

Regency  
MX5000

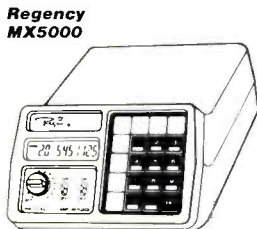

Regency  
HX1000



Regency  
HX650







Here's a typical cellular base station antenna.

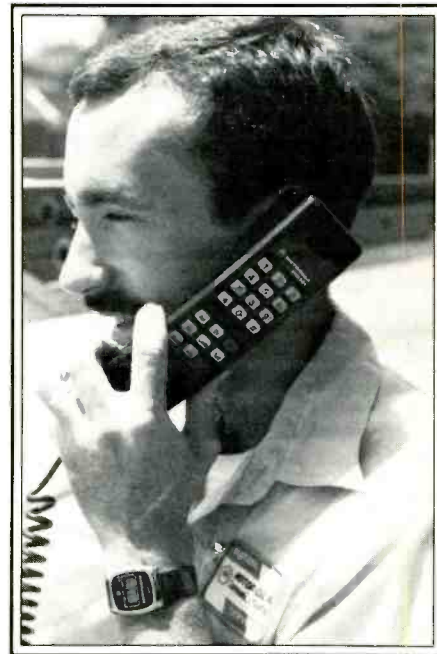
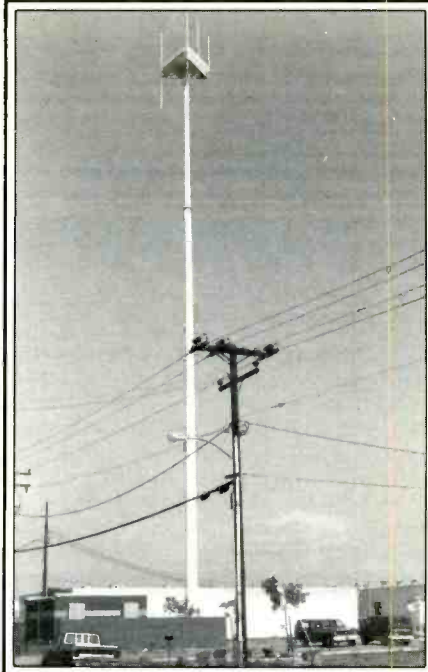

The cellular telephone's handset contains most of the programming controls.

A mobile cellular system consists of three major components: the remote control head with handset, the trunk-mounted transceiver, and the antenna.

**More Than You Ever Wanted To Know About**

# Cellular Mobile Telephones

BY GORDON WEST, WB6NOA

**I**t's finally here—an \$8.8 billion car telephone service that works exactly like your home or office phone system. No more waiting for an open channel, no more noisy connections, no more missed calls because you were “out of range.” All of these problems have been solved with a new generation of mobile telephones—the cellular mobile radio (CMR) network.

## The History Of Car Phones

Car telephones have been around for years, but operating a car telephone was like operating a two-way radio. The very early car telephone systems required saying “over” before the other party on the phone could talk back to you in your vehicle. Those early car telephone systems were also plagued with static if you were more than a few miles from the base transponder. You often had to wait up to 15 minutes before the channel was clear to make a phone call. You also had to have your unit placed on the proper channel to receive a phone call if the telephone service offered this feature.

Car telephones in the 1970's went into a slightly refined stage called “Improved Mobile Telephone System” (IMTS), with now only 150,000 users crowded onto just a handful of channels. This would allow for full duplex conversations, similar to a regular phone call. You would not have to drop in the word “over” when you expected a response from the party on the phone. Full duplex would also allow both parties to interrupt each other during a phone call, which is convenient to keep someone from being long-winded. However, the IMTS system still used only 54 VHF and UHF channels, and these channels would become occupied for sometimes hours during rush hour. When you finally did make your connection, you were acutely aware that you were operating a fragile radiotelephone system rather than your trusty old telephone apparatus back at the office. You had to worry about not parking under a bridge for fear you might get cut off from the party you finally contacted through the chance of an open channel during rush hour. You also had to contend with static, adjacent channel

interference, and spark plug noise from the dune buggy right behind you on the freeway.

## Finally, Cellular

We are now entering into a whole new world of mobile telephone communicating. Instead of operating your telephone like a radio station, you simply pick it up and make a phone call just as if you were in the office. As you drive around town, your cellular car phone will stand ready for any incoming phone call.

“I receive probably 25 phone calls a day, and rarely will the calling party know that they are talking over a car telephone





*A cellular mobile phone installation is neat and attractive.*

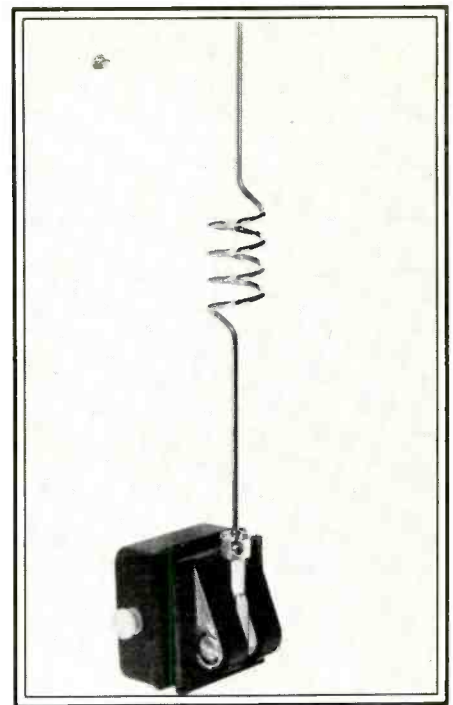

*Antenna Specialists produces this mobile antenna suitable for cellular operation.*

system," comments Katherine Jorgenson, a new Orange County, California, cellular radiotelephone user.

"Even when I tell them I am talking from a car phone, they don't believe it—there's no static, no echo, no garbled sound—only a clear connection exactly like a regular, everyday telephone conversation," adds Jorgenson.

The cellular telephone system utilizes 666 channels in the 800 MHz region, 40 MHz wide. These ultra-high radio frequencies are well above the very highest frequency you can receive with a UHF tuner on your TV set. Propagation characteristics of low-power signals on this band are quite predictable, and there is seldom a problem from amplitude modulation ignition noise, power line noise, radar noise, and even CB radio transmissions that sometimes occlude regular mobile telephone frequencies. Signals at 800 MHz propagate crystal clear, and are by nature line of sight.

Well, almost line of sight. At 800 MHz, signals tend to reflect quite easily off of steel buildings, concrete walls, and other structures that one might consider obstacles to incoming signals at lower frequencies. This allows you to transmit and receive signals from low-power stations in underground garages, in tunnels, and in among high-rise buildings.

Out in the open, 800 MHz tends to fill in shallow valleys and even reflect around ridges and refract over tall mountains. Although one would think that 800 MHz waves won't go as far as other radio waves on lower frequencies, they do!

Unlike other mobile telephone systems that rely on a single mountaintop transmitter to service mobile units on a specific mobile phone channel, the cellular radiotelephone

system is based on distance, contour-engineered, hexagonal cells that are interconnected to provide a mobile unit uninterrupted coverage within a defined service area. Each individual cell is developed by precision field strength measurements to a central, low-power transmitter and receiving antenna system that serves only that cell. The mileage that any one cell may cover is dependent on the expected usage of car phones within that cell. Out in the open country, a cell might encompass up to 10 miles in radius. However, in downtown areas or around busy airports, a cell could be as small as one-half mile. Each system may contain up to 333 full-duplex channels, all of which are reusable as soon as a mobile unit goes from one cell to another.

Now comes the best part of cellular radio and the ability to always access an open channel. As you drive from one cell to another, your radio system automatically is handed off from the cell you're leaving to the next cell with available channels that you are entering into. This requires, needless to say, some sophisticated, computerized equipment in both your mobile unit as well as at the individual cell sites. Computerized module control units (MCU), electronic switching systems (ESS), and mobile telephone switching offices (MTSO), will keep your calls loud and clear as you drive from one cell to another. As you leave a cell, your signal strength begins to rapidly decay, and this begins the hand-off sequence. When another cell senses your signal is getting stronger, or detects a favorable doppler shift, it will automatically take your call in less than 100 milliseconds. You won't even know that you have changed over to a new transmitter/receiver station. Such handoffs might occur several times in the course of a

conversation as the mobile unit moves from cell to cell in the coverage area.

"Our customers have been quite impressed with the reception of telephone conversations here in Orange County, California. Only now and then in the start-up stages of our system have they noticed a change in audio level as their computerized equipment switches from one cell to another," comments Mark Sheppard of Sheppard Communications, Huntington Beach, California, a specialist in cellular telephone installation and service. "From a technical standpoint, the system is truly amazing; we have only had it on the air for a few months, and there are only a few bugs to be worked out," adds Sheppard.

The electronic layout of each cell is also a marvelous work of art that is tough to compute on paper, and even harder to make work in the real geography of where the system is implemented. Thousands of hours of field strength tests are required to establish cell boundaries, and even simple changes from day to night and summer to winter may adversely affect cellular range unless all of these factors have been taken into account in the original engineering process.

"Our cellular system went on the air in February," comments an East Coast cellular radiotelephone engineer. "For the first two months, our coverage was exactly as planned—then spring came. Just as we predicted, each cell shrank in coverage area because the new foliage began to absorb our 800 MHz signals!" adds our Eastern engineer. They had planned for this, and nicely adjusted their transmitter and receiver antennas to take up the seasonal variations in coverage.

The best part of this whole system is that you will never know that you are going from



## Cellular History

**1921**—Detroit police begin using first mobile telephone service.  
**1946**—First commercial mobile service introduced by Bell System in Saint Louis in 150 MHz band.  
**1949**—FCC establishes radio common carriers.  
**1956**—FCC opens 450 MHz band for common carrier use.  
**1958**—Bell proposes a 75 MHz bandwidth system in the 800 MHz band.  
**1964**—Automatic operation mobile service inaugurated. Improved Mobile Telephone Service (IMTS) eliminates need for push-to-talk operation and allows customers to do own dialing.  
**1968**—FCC opens Docket 18262 to focus attention on mobile service and seek more efficient systems.  
**1970**—FCC conducts investigation of mobile service and finds urgent need to expand and improve service; invites industry to propose innovative mobile system.  
**1971**—AT&T files proposal for development of cellular mobile system.  
**1974**—FCC allocates 40 MHz of 800-900 MHz spectrum for cellular systems and opens filing to all those interested in developing cellular systems.  
**1975**—FCC modifies 1974 ruling to include RCCs.

**1975**—Illinois Bell files application with FCC to begin developmental test of high-capacity cellular system in Chicago area.  
**1977**—Licenses granted for Chicago system and to American Radio Telephone Service (ARTS) for Washington, DC/Baltimore area.  
**1978**—Experimental service begins in Chicago, serving about 2,000 customers.  
**1980**—FCC issues inquiry and proposed rulemaking for cellular service, emphasizing need to expedite the process to bring service to the public as quickly as possible. Advanced Mobile Phone Service (AMPS) created as AT&T subsidiary to develop and market cellular service nationwide.  
**1981**—FCC issues report and order outlining rules for cellular industry.  
**1982**—FCC decision on reconsideration creates competition by dividing each of the 90 largest markets into two licenses—wireline and non-wireline. Some 194 applications for top 30 markets pour into FCC in June. Avalanche of nearly 400 applications for markets 31 through 60 in November.  
**1983**—Additional 560 applications filed for markets 61 through 90 in March. FCC approves Ameritech system in Chicago, with first U.S. commercial cellular service beginning a week later.

one radio zone to another, and everything does its thing automatically, silently, and you will never miss a call!

## Cellular Availability

Before you start thinking about equipment, make sure that your city is on the air with the new cellular system. Thirty major cities are on the air now with cellular radio, and 95 more cities will be on the air by January, 1985. Before you begin shopping for cellular radiotelephone equipment, be sure to find out the progress of cellular radio in your area! It may still be a year off!

## Finding The Right Dealer Connection

Everyone in the mobile electronics industry is reaching for cellular radiotelephone business. Although two-way radio sales and installation have normally gone to the professional land/mobile radio dealer, organizations such as Radio Shack, car auto installers, new car dealers, and even your local garage/radio entrepreneur is both selling the equipment as well as offering installation of the equipment.

Although there is a great debate in the mobile radio industry as to who should truly

do the selling and servicing of the equipment, there is so much equipment available that everyone wants in on the act. A word of caution—you should choose your dealer and installer carefully.

“Now that we have begun shipping products, there will be quite a few auto sound dealers getting into the cellular market,” indicates Audiovox President, John Shalam. He further indicates that their new equipment will first be sold to new car dealers; but when supply begins to build up, they may look for additional distribution.

“Auto sound dealers are going to give it a try. I’m not sure the numbers will be too sub-

## Cellular Radio: Glossary

**Access number:** The mobile telephone number assigned to a customer giving the user access to cellular service.

**Cell:** A section of the coverage area, usually one to eight miles in radius, and the basic geographical element upon which cellular service is based. Conceptually, the cell is hexagon-shaped; in actuality its shape depends on geographic considerations.

**Cell site:** The base station of a cell which includes an antenna and low-powered transceivers and computerized equipment to serve mobile units in that cell. Each cell can access up to 45 of the 333 channels the FCC has reserved for each cellular system.

**Cellular Geographic Service Area (CGSA):** The coverage area of a cellular system in which high quality telephone service can be obtained. Users frequently will be able to use their units beyond the CGSA, but the quality of the transmission may not be at optimum levels.

**Duplex service:** A service which permits the user to speak and listen at the same time as in standard telephone service. Some mobile and portable phone services allow only one-way communication.

**Improved Mobile Telephone Service (IMTS):** Until the introduction of cellular service, IMTS was the most sophisticated mobile service available to consumers. Its limited channels are inadequate to meet the demands for mobile communications existing today. Cellular will not eliminate IMTS, but most IMTS telephone units will not be compatible with the cellular system.

**Module Control Unit (MCU):** The microprocessor at the cell site transmitter which monitors the signal strength of all calls. When a

signal drops below a preset level, the MCU signals the Mobile Telephone Switching Office, which controls the network of cell sites.

**Mobile Telephone Switching Office (MTSO):** The electronic center that controls the network of cell sites in a geographic area. The MTSO performs a number of functions, but the most important from a user’s point of view is monitoring and transferring calls as the user moves from cell to cell.

**Party Line:** The type of service found on some older mobile telephone systems which, because of the nature of the technology used, allows users to hear calls made by other users. Cellular mobile technology assures greater privacy through the use of numerous, random frequencies to carry calls.

**P.02 Grade of Service:** The grade of service engineered by Pac-Tel Mobile Access. This means that customers can expect to experience a busy signal (all channels busy) in only two out of 100 attempts during the busiest hours.

**Roaming:** The act of sending or receiving a call in a cellular service area other than the unit’s home CGSA. National cellular carrier agreements are expected to permit PacTel customers to use their units in other areas equipped with cellular systems.

**Scratch Pad Dialing:** Feature on cellular mobile telephone unit which allows a number to be stored at any time, even when the unit is engaged on another call.

**Wireline company:** A telephone company or its parent corporation. Each coverage area will be authorized one cellular service affiliated with a wireline company and one owned by a non-wireline company.

## Cellular Phone Manufacturers

**Advanced Cellular Technology Inc.**  
Henri Van Houten, VP-Sales and Marketing  
1919 Hartog Dr.  
San Jose, CA 95131  
408/293-2923  
*Mobile phones*

**The Antenna Specialists**  
Rick Reed, Sales Manager, Cellular  
12435 Euclid Ave.  
Cleveland, OH 44106  
216/791-7878  
*Suppliers of cellular base and mobile antenna systems.*

**Auxton Computer Enterprises Inc.**  
Jim Thompson, VP-Marketing  
200 E. Robinson St., Suite 1560  
Orlando, FL 32801  
305/425-3300  
*Customized cellular software*

**Avantek**  
Scott Helling, Manager, Powertek Amplifier  
Applications 481 Cottonwood Dr.  
Milpitas, CA 95035  
408-946-3080  
*Power amplifiers, pre-amplifiers and oscillators*

**Cellular Radio Systems**  
Kenneth Orashan, president  
5730 S. Kenton Way  
Englewood, CO 80111  
303/370-6073  
*Mobile units*

**Celwave Technologies Inc.**  
Oscar Harris, Manager, Cellular Products  
Rt. 79  
Marlboro, NJ 07746  
201/462-1880  
*Complete cellular base and mobile antenna systems, duplexers, combiners, cable.*

**Chatlos Systems Inc.**  
Amy G. Peters, Regional Account Executive  
125 Algonquin Pkwy  
Whippans, NJ 07981  
201/887-1456 or 800/631-8117

**CTI Inc.**  
Jim Tucker, President  
P.O. Box 71, Highway 45 South  
Corinth, MS 38834  
601/287-8081  
*One- to 4-cell systems*

**Decibel Products Inc.**  
Bob Corwin, Director of Marketing  
3184 Quebec  
Dallas, TX 75247  
214/631-0310  
*Complete suppliers of RF antenna systems.*

**E.F. Johnson Co.**  
Mobiletelephone Systems Operation  
Nick Stanley, J. Michael Anderson, Tom Asp  
299 Johnson Ave. S.W.  
Waseca, MN 56093  
507/835-6222  
*Complete product line of RF equipment: mobiles, subscriber units, cell site radio systems, complete Celltrex turnkey cellular system through ITT Telecom*

**Ericsson Communications**  
Radio Systems Unit  
Mats Ljunggren, Marketing Manager  
1290 Wall St. W

Lyndhurst, NJ 07071  
201/939-5300  
*Turnkey systems*

**Fujitsu America Inc.**  
Kiyoshi Kawai, Director, Radio Communications  
or Sales Manager  
10 E. 53rd St.  
New York, NY 10022  
212/308-7920  
*Base station radios, mobile and portable units*

**General Electric Company**  
Mobile Communications Business Division  
John Berti, Jack Hurley  
Mountain View Rd.  
Lynchburg, VA 24502  
804/528-7242  
*Everything from mobile/portables to turnkey systems; marketing system with Northern Telecom*

**Glenayre Electronics**  
Dave Leop, Cellular Product Manager  
12 Pacific Highway  
Blaine, WA 99230  
206/676-1980  
*Mobile units*

**Harris Corp., RF Communications Group**  
Mobile Telephone Division  
Nick Studer, National Sales  
1680 University Ave.  
Rochester, NY 14610  
716/244-5830  
*Full system turnkey supplier, including mobiles; portables at a later date, IMTS cellular transition package available*

**Hitachi America Ltd.**  
Dudley M. Meyer  
National Accounts Manager  
290 Gateway Dr., Suite 1000  
Norcross, GA 30071  
404/446-8820  
*Mobile units*

**ITT Telecom**  
Network Systems Division  
H.E. Rollin, Program Director  
3100 Highwoods Blvd.  
Raleigh, NC 27604  
919/872-8951  
*Complete turnkey Celltrex cellular systems (large to small); base radios and mobile units offered through agreements with other vendors*

**Japan Radio Co. (JRC)**  
c/o Nissho Iwai American Corp.  
Takao Tsuji, Manager-Electronics Dept.  
1211 Ave. of the Americas  
New York, NY 10036  
212/730-2228  
*Mobiles, portables and base station RF equipment*

**Kathrein Inc.**  
William A. Wickline, P.E., President  
26100 Brush Ave., Suite 319  
Cleveland, OH 44132  
216/289-1271  
*Professional antenna systems*

**Kokusai Electric Co. Ltd. America Mike**  
Musso, Naoya Kimura  
363 Coral Circle  
El Segundo, CA 90245  
800/421-5702, 213/615-3191  
*Mobiles, base stations, portables under development*

**Millidyne Inc.**  
Al Kruhm, program manager  
1770 Walt Whitman Rd.  
Melville, NY 11747  
516/420-0757  
*Complete turnkey systems*

**Mitsubishi International**  
Robert Foley, Supervisor  
Communications Equipment Sales  
1098 Tower I.a.  
Bensenville, IL 60106  
312/595-6494  
*Mobile/portables, base station equipment and turnkey systems in conjunction with Stromberg-Carlson*

**Mobira Oy**  
Kari-Pekka Wilska, Vice President  
P.O. Box 86, SF-24101 Salo 10, Finland  
011-358-24-6101  
Telex 6823 mobi sf  
*Mobile units*

**Motorola Inc.**  
Phil Petersen  
Strategic Sales Manager  
Common Carrier Markets  
1301 E. Algonquin Rd., SH 4  
Schaumburg, IL 60196  
312/576-3058  
*Complete turnkey systems, from engineering design through installation and maintenance; mobile/portables*

**NEC America Inc.**  
Mobile Radio Division  
Vernon Hull, Manager, Mobile Engineering  
4936 W. Rosecrans Ave.  
Hawthorne, CA 90250  
213/973-2071  
*Complete turnkey systems, from engineering design through installation and maintenance; mobile/portables*

**New England Engine Corp.**  
Stephen Faulkner  
Cellular Marketing Manager  
Route 1, P.O. Box 335  
Rowley, MA 01969  
617/948-7331  
*Emergency generators for cellular transmitting sites.*

**Northern Telecom Inc.**  
Raju Patel, VP-Marketing  
1201 East Arapaho Rd.  
Richardson, TX 75081  
214/234-7782  
*Complete "Enterprise" turnkey systems (switching) in conjunction with General Electric (radio portion)*

**Northern Telecom**  
Bill Adams, Director, DMS-10 Marketing  
4001 E. Chapel Hill-Nelson Highway  
Research Triangle Park, NC 27709  
919-549-5000  
*Cellular software for DMS-10, a small central office switch*

**NovAtel Communications Inc.**  
(Formerly Westech/Systems Inc.)  
David Frye, Vice President-C.O.O.  
2820 Peterson Pl.  
Norcross, GA 30071  
404/449-6666  
*Mobile phones and systems, including engineering*

**OKI Advanced Communications**  
Tony Russo, Vice President  
1 University Plaza  
Hackensack, NJ 07601  
201/646-0011  
*Mobile/portables*

**Panasonic Industrial Company**  
Telecommunications Division  
Carl Mathis, National Sales Manager  
1 Panasonic Way  
Secaucus, NJ 07094  
201/348-7933  
*Mobile/portables, complete systems*

**Quintron Corp.**  
Neil Quellhorst  
Program Coordinator, Cellular Products  
1 Quintron Way  
Quincy, IL 62301  
217/223-3211  
*Flexible cell-site equipment, single-cell system*

**Stromberg-Carlson Corp.**  
Bill Woodruff, General Manager  
P.O. Box 7000  
Longwood, FL 32750  
305/339-1600 x161  
*Mobile/portables, base station equipment and turnkey systems in conjunction with Mitsubishi International.*

**Tactel Systems Inc.**  
(Formerly Tactec Systems Inc.)  
William H. Cole, Vice President, Marketing  
Country Club Rd.  
Meadow Lands, PA 15347  
412/228-6570, 6476  
*Mobile/portables*

**TeleConcepts Inc.**  
Robert Winkler, president  
36 Holly Dr.  
Newington, CT 06111  
203/666-5666  
*Mobile units*

**Telesaver Inc.**  
Joel Maloff, Director  
Systems Marketing and Sales  
20 Gwynns Mill Court  
Owings Mills, MD 21117  
301/363-2500  
*Small cellular switch*

**Toshiba America Inc.**  
(Represented in the U.S.  
by Tactel Systems Inc.)

**Valmont Industries**  
Larry Hbler, Tom Kyle  
Valley, NB 68064  
402/359-2201  
*Manufacturer and installer of cellular pole and tower structures.*

**Walker Telecommunications Corp.**  
Burt Walker, president  
200 Oser Ave.  
Hauppauge, NY 11788  
516/435-1100  
*Mobile units*

**Western Electric**  
Commercial Sales Organization  
P.O. Box 28000  
Greensboro, NC 27420  
800/334-8155  
*Complete system and services offerings*

stantial this year, but by 1985 it will be an entirely different story."

Radio Shack, via its parent company, Tandy Corporation, will also join the national retailers who will be carrying cellular mobile phones. A local Southern California Radio Shack dealer indicates that he has received many inquiries about the new cellular phone system.

What's the first question that everyone asks? *What's the price of a typical cellular system?* Today it's \$3,000 for purchasing the equipment outright, but by next year industry experts predict that the price may drop to as low as \$2,000. One new manufacturer is promising a \$1,000 unit!

The second most often asked question?

*How much does it cost to make a phone call?* Many systems throughout the country charge approximately \$30.00 to \$45.00 per month for the service and about fifty cents per minute for phone calls. When the service charge is around \$60.00 per month, the actual on-the-air charges may drop to as low as twenty-five cents per minute. Some companies may charge no basis air time fee, but you must guarantee them several hundreds minutes of on-the-air time per month at a pre-determined dollar amount.

As an average, once you have purchased your \$3,000 cellular phone, it will probably cost you an additional \$125 per month to place and receive calls.

The actual installation of the equipment is

quite straightforward. Twelve VDC feeds the 3 watt, 9 pound transceiver unit buried in your trunk or under the seat. An interconnect data cable then marries the 28-ounce control head with your hidden transmitter/receiver. Coaxial cable (it looks like CB cable, but it's actually very expensive, low-loss cable) interconnects your trunk transmitter/receiver to a 7-inch antenna that has curls in the mid-section.

Although almost anyone can basically install the equipment, the programming of the setup is crucial to the proper operation of your unit. If you buy your cellular radio from one organization, and then have it installed somewhere else, chances are you are not going to be satisfied with its performance. I



## Answers To Common Questions About Cellular Telephone

**Question:** Are there any commercial cellular telephone systems operating in the U.S.?

**Answer:** Yes. Chicago became operational last year. The other 29 cities in the Top 30 which should be operating by the end of 1984 are:

New York Metro  
Greater Los Angeles  
Philadelphia  
Detroit/Ann Arbor  
Boston Metro  
San Francisco/Oakland  
Washington, DC  
Dallas/Fort Worth  
Houston  
St. Louis  
Miami/Ft. Lauderdale/Hollywood  
Pittsburgh  
Baltimore  
Minneapolis/St. Paul  
Cleveland

Atlanta  
San Diego  
Denver/Boulder  
Seattle/Everett  
Milwaukee  
Tampa/St. Petersburg  
Cincinnati  
Kansas City  
Buffalo  
Phoenix  
San Jose  
Indianapolis  
New Orleans  
Portland, OR

**Q:** How many cells do you need to service a metro area?

**A:** This will depend on the size of the city, its topography, and the number of subscribers on the system. Cells can be subdivided at any time to meet traffic needs. It has been estimated that a market like Washington, DC, would need 7 to 18 cells. The initial three cell test set-up for Jacksonville likely would be tripled when commercial operation begins.

**Q:** What frequencies are used for cellular telephone?

**A:** The FCC has assigned 666 channels between 825-845 MHz and 870-890 MHz for use in each market. There is a 30 kHz spread between channels to eliminate "crosstalk" or interference.

**Q:** Will a cellular telephone ever be used for data transmission?

**A:** That is a planned future application. Stockbrokers, real estate agents, and others may eventually be able to receive and transmit data over their in-car cellular radiotelephone linked via a modem to a portable terminal or computer.

**Q:** Will the advent of cellular wipe out the present market for mobile radio?

**A:** Not at all. Some small businesses will certainly switch to cellular, but major users—police, fire, service organizations—will continue to operate their own dedicated systems.

**Q:** Will cellular telephones be offered by auto makers as optional equipment?

**A:** Absolutely. Automobile makers have already seen the potential of cellular telephones. General Motors is offering them on one model in the Chicago market, and Ford plans to make them available on 1985 models. Three car rental companies have announced their intention to make the units available in selected models.

**Q:** What about overseas?

**A:** Several countries are already using a form of cellular service. A Scandinavian system serving Norway, Sweden, Denmark, and Finland has some 48,000 subscribers, and one in Saudi Arabia recently began with 2,000 subscribers but expects to have 19,000 by the end of 1984. Other countries with cellular systems are Japan and Australia.

## EasyTalk™

PERSONAL RADIO COMMUNICATORS

Walkman Style Walkie Talkie  
Communication Devices up to 1/2 mile range.\*

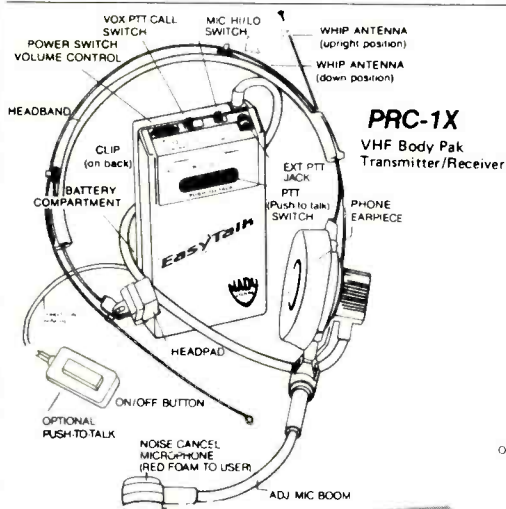

**PRC-1X**  
VHF Body Pak  
Transmitter/Receiver

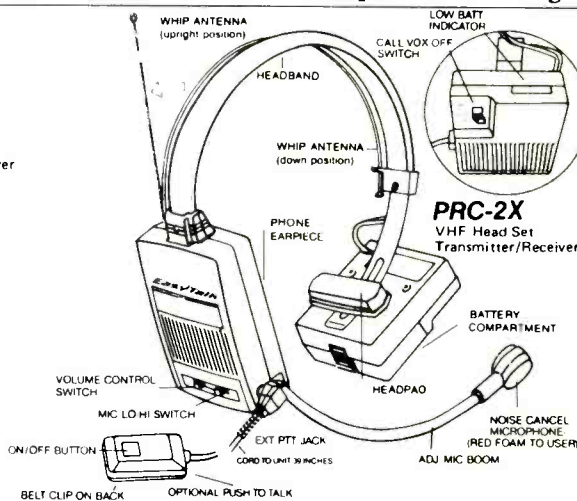

**PRC-2X**  
VHF Head Set  
Transmitter/Receiver

**AUTOMATIC OR MANUAL TRANSMISSION:** Voice-triggered VOX operation allows hands-free operation, or can be operated manually with either PTT (Push-to-Talk) switch on unit, or remotely with plug-in PTT switch on one meter cable.

**CHOICE OF MODELS:** Choose the model best suited to your application. The PRC-1X is a body pack transmitter with an attached headset. The PRC-2X is a transceiver completely housed in the headset.

**\*NEW EXTRA FEATURES**

**BEEPER "CALL":** EasyTalk™ unit can be put in "call" mode when headset is removed. Loud, intermittent beeps clearly signal incoming calls.

**NOISE-CANCEL MICROPHONE:** Unidirectional microphone responds only to user's voice and eliminates most loud, extraneous noises, allowing VOX operation in higher noise environments.

**LOW BATTERY INDICATOR:** To guarantee optimum performance, flashing LED signals user when battery is low and needs replacement.

### 13.5 KV High Voltage POWER SUPPLY



New hi-volt power supplies made by Wabash Co. Their original use was probably to electrify the coronas in a photo-copy machine. The high voltage nature of this device should "spark" your imagination - small lasers or bug zappers, etc. Input 115 V, 60 Hz. Output 13.5 KV 0.5 ma. Shpg. Wt. 6 Lbs SPL-470-33A \$12.00

**SPECIFICATIONS (GENERAL)**

**Power Source** • 9VDC (Type 006 Px1) or (Type MNI604x1) Alkaline  
**Frequency Range** • 49.830 - 49.890 mHz  
**Current Drain** • Standby 15mA/Receive 65mA/Transmit 85mA  
**Service Area** • Approx. 1/4 Mile (400 meters) Optimum Conditions-to 1/2 Mile  
**Dimensions** • 4.68" (H) x 2.44" (W) x 1.06" (D)  
**Weight** • 8.92 oz. (250 grams)

PRC 1X VHF BodyPak \$50.00 2/\$95.00  
PRC 2X VHF Headset \$50.00 2/\$95.00  
PRC 3X VHF BodyPak similar to PRC 1X, but full duplex \$60.00 2/\$115.00  
Push to Talk button for PRC 1X & 2X \$10.00 @

This product is new & guaranteed functional. Comes w/ 9 volt battery.

# John J. Meshna Jr., Inc.

19 Allerton Street • Lynn, MA 01904 • Tel: (617) 595-2275



CIRCLE 20 ON READER SERVICE CARD



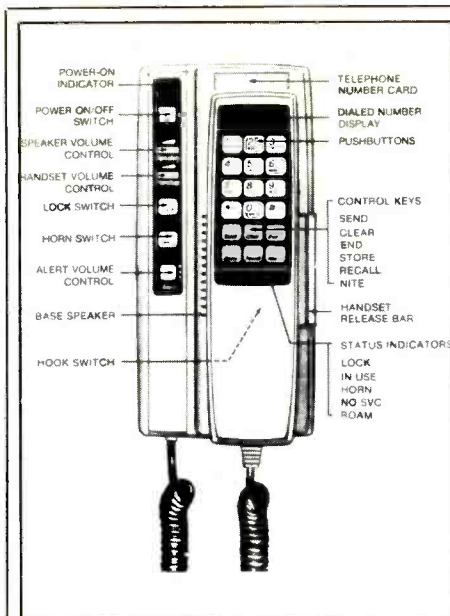

### A Technical Overview On How Cellular Mobile Phones Work?

The cellular telephone that mobile systems customers will use is similar to pushbutton telephone, but has some modifications to make it easier to use in a car.

Cellular phones differ from conventional phones in that the numbers are not transmitted as they are dialed—one at a time. Rather, to minimize on-air time, they are stored—with a display allowing the user to see what number has been dialed—and then are transmitted all at once when the “SEND” button is pushed. Another change allows the number to be entered and sent with the handset still on the hook.

The mobile phone includes a speaker in the base, as well as one in the handset. This allows the user to hear the called party answer before having to pick up the phone. In fact, when the optional “hands-free” feature is purchased, the user need not pick up the handset at all—a major convenience on winding roads or in heavy traffic. When the hands-free feature is used, the customer “hangs-up” by pushing the “END” button.

The “POWER ON/OFF” button allows the user to turn the phone off to avoid being disturbed. Or, while away from the car, the user can leave the power on (and the car key in the auxiliary power position) with the optional horn alert feature activated. This blows the horn anytime a call is received. An alternative installation activates the lights

rather than the horn. The “ALERT VOLUME CONTROL” adjusts the ring volume.

When a car is left with attendant parking or in other situations where the customer is concerned about unauthorized use of the phone, the unit can be locked electronically by pushing the “LOCK” button. The phone is unlocked by pushing a preset three or four-digit code known only to the customer.

Other features include separate volume controls for the base and handset speakers and a switch that adjusts the brightness of the lighted displays for easy viewing.

The cellular phone also includes a num-

ber of features common in advanced push-button phones. These include “Last Number Recall” (the last number dialed can be redialed just by pushing SEND), “Repertory Dialing” (10 or more telephone numbers can be stored and recalled by a two-digit code), and “Scratch Pad Dialing” (a number can be stored for dialing at any time, even when the phone is in use on another call).

Wherever the user goes within the cellular system, cellular phones provide instantaneous, direct access to the nationwide public telephone system—to local, long distance, or even international calls.

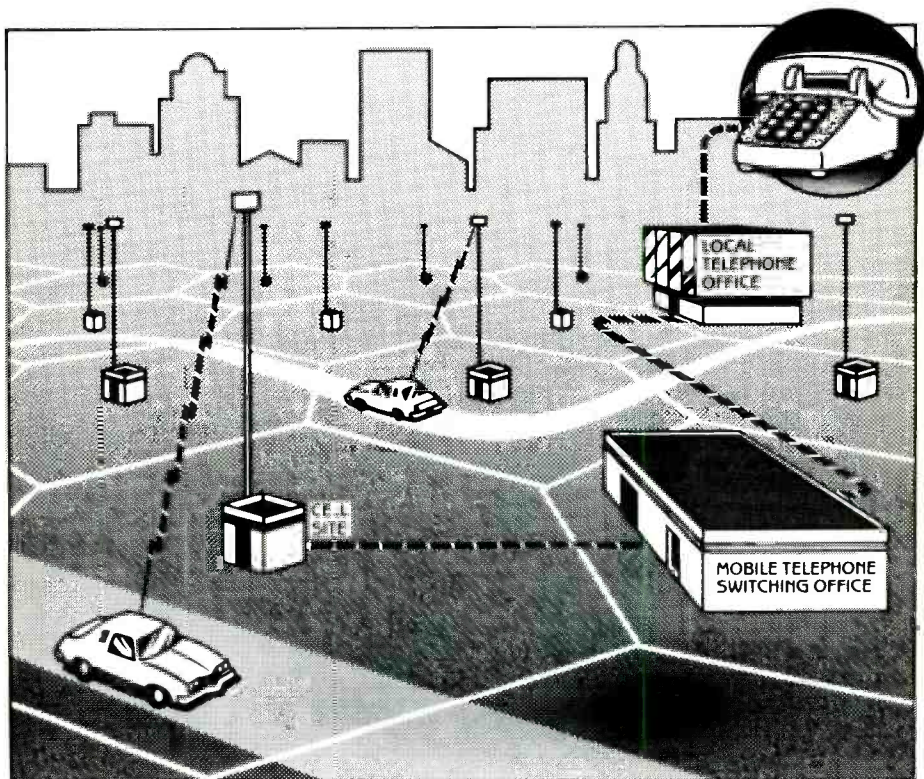

Cellular technology is based on a grid of hexagons, or cells, that cover specific geographic areas. Each cell contains a low-powered radio transmitter and control equipment located in a building called a cell site.

The cell site is connected by wireline facilities to a Mobile Telephone Switching Office (MTSO), which is connected to the regular landline network through the telephone central office. With its electronic switching capability, the MTSO monitors the mobile

units and automatically switches or “hands-off” conversations in progress as the mobile unit moves from one cell to another.

Each cell has a set of radio frequencies, allowing reuse of every channel for many different simultaneous conversations in the given service area.

As demand for the service grows, dividing cells into smaller cells can meet customer needs even in the most densely populated areas.

recommend you only buy the cellular equipment from an organization that provides all of the service and programming for your particular piece of equipment on the specific service offered in your local area. This way you will end up with good service from a compatible unit that can take advantage of all of the benefits of cellular radiotelephone coverage.

And now the icing on the cake: With cellular, the scanner crowd won't be able to

eavesdrop on your constantly channel-switching phone calls. For every 100 times you pick up the handset to make a phone call, you will receive a dial tone within one second at least 98 of those times. The other two times, you may have to wait approximately 20 seconds before your unit finds a dial tone—and that's not bad!

The tiny handset will memorize 30 often-called phone numbers and prioritize all of those emergency numbers that you never

can remember. It will double as a minicalculator. It will also tell a calling party that you are out of the car and instruct them to punch in their phone number.

Need I say more? If you are the professional that constantly needs to stay in touch while in your vehicle, the cellular radiotelephone service may be just the answer for you. Stop by any business radio dealer for a demonstration. By 1990, there may be 12,000,000 users. Will you be one? **PC**



# Radio's Prophet Of Hate



Rev. Charles E. Coughlin, also known as "The Radio Priest," makes a point while airing his weekly program from the WJR studios in Detroit.

## **Broadcasting Had Made Him The Second Most Popular And Powerful Man In The Nation – Just Before It Sent Him Into Obscurity!**

BY TOM KNEITEL, K2AES, EDITOR

In the 1920's, radio broadcasting had become a fact of daily life in North American households. Almost immediately there were those who saw the immense potential that broadcasting held for news reporting, selling products, entertainment, religious

and educational programming. There were those who had come into broadcasting after long years in vaudeville or theatre, on the concert stage, or at the pulpit or the lecture podium, and found that their talent and prior experience did not necessarily translate

well into the new medium. Yet there were those who had a certain *something* that had an enormous appeal to radio audiences regardless of how much or how little prior experience they had; they had a natural ability to use broadcasting to its ultimate potential. There were only a handful of such people in the early days, and Charles E. Coughlin was definitely one of them. Coughlin was one of the first to use broadcasting as a springboard to immense national fame, and one of the first to learn that broadcasting could thrust one into controversy and obscurity with equal rapidity.

### **Charles E. Coughlin**

Charles Edward Coughlin was born in Hamilton, Ontario, of Irish immigrant parents on October 25, 1891. In 1916, at age 25, he was ordained as a Catholic priest. His next ten years were spent in a variety of church-related tasks. Those who had contact with him were quick to notice and acknowledge that he had a way with people, a winning charm that was certainly aided by his appealing brogue.

In 1926, Rev. Coughlin was appointed as a pastor of The Shrine of the Little Flower, located at Woodward at 12 Mile Road in the Detroit suburb of Royal Oak. Almost immediately upon Coughlin's arrival at Little Flower, he set about thinking up a way to gather new members to his small wooden church.

He came up with the concept of a weekly radio broadcast—"The Golden Hour," he called it—which would be conducted every Sunday afternoon at 4 p.m. The idea of "The Golden Hour" was to appeal not only to Catholics, but also Protestant and Jewish listeners, and present an hour of quiet reflection upon life. Taking his idea to WJR, a major broadcaster in Detroit, Coughlin was put on the air locally in 1926. At first uneasy with the technique of broadcasting, Coughlin's original broadcast brought in a scant five letters from listeners. Working to improve his broadcasting technique, within a few weeks he received one hundred letters after one of his programs. As he polished his style, his audience grew, and it wasn't very long before his broadcasts were being aired over WLW in Cincinnati and WMAQ in Chicago, both major clear-channel stations.

As his popularity and audience expanded, he increased the scope of the topics which he covered each week. While the basic content centered upon religious matters and living a virtuous life, the talks started to be spiced up with peppery and eventually vitriolic comments and pronouncements relating to the national economy and his opinions on a variety of prominent people, especially statesmen. Audiences loved every word of it and within a relatively short time, Coughlin's lively program was being carried on the entire national CBS network.

His relationship with CBS was far from smooth. In January of 1931 the network had begun to react with alarm to his remarks, which they believed were becoming far too political and which frequently

smacked of what the network perceived as anti-Semitism. CBS demanded that they be given an advance look at the "Radio Priest's" scripts in order to censor them. Coughlin reacted with rage to the suggestion and spent the week's program loudly berating CBS and telling his listeners to write to him to express their support. More than a million letters were received at Royal Oak. CBS was unimpressed, so much so that they pulled the plug on Coughlin and threw him off the network. Coughlin then tried to arrange for his program to go out over the NBC network. NBC, however, was able to avoid the controversial air personality by hiding behind a broadcast policy that they said wouldn't permit them to air "commercial religious broadcasting."

Undaunted, Coughlin told Leo J. Fitzpatrick, General Manager of WJR in Detroit (his key outlet) of his plight. Fitzpatrick swung into action and began making contacts and arrangements with independent broadcasters in certain selected areas. Using the \$500,000 (per year) Coughlin had coming in the form of voluntary contributions from his listeners, Fitzpatrick established a mini-network by purchasing air time of 35 stations. Research has shown that these stations were all in areas where the Depression had hit the hardest.

Coughlin never asked his listeners directly for money, but each program had the announcer pointing out that the hour was made possible "by the outstanding financial support of the radio audience." Coughlin was, by then, also publishing a magazine titled *Social Justice* so that his political views might be explained in greater and harsher terms than was possible in his broadcasts. In addition to the magazine, *The League of the Little Flower* (membership \$1), which was also run by Coughlin, began publishing books that were compilations of Coughlin's radio speeches.

Regular targets for Coughlin's oratory were those things he hated most and which he felt his audience also detested. This included bankers, socialism, and the uneven distribution of wealth. He also hated President Herbert Hoover, whom he blamed for the Wall Street collapse of 1929 and the ensuing Depression. By this time his audience had grown to 30 million in size and he was receiving 10,000 letters per day. Most of these letters contained a ten cent to one dollar contribution to help keep him on the air.

Coughlin was one of Franklin D. Roosevelt's earliest and most vocal supporters during the 1932 political campaign. Depression-weary Americans drew courage and saw a ray of hope for the future when Father Coughlin proclaimed Roosevelt as being "about 20 years ahead of the thought that is current in the country today." There were rumors that with Roosevelt's winning of the 1932 election, Coughlin would leave the church to accept a high position in Roosevelt's New Deal administration.

Coughlin's oratory style, it should be noted, had been developed and honed into a powerful tool by 1933. Gone completely

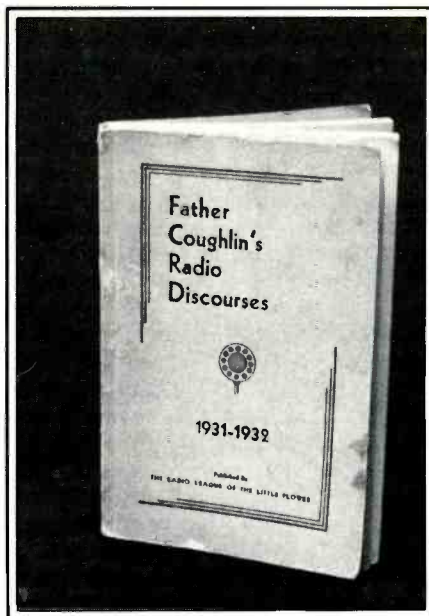

*Father Coughlin's lengthy radio discourses were collected and published for sale to his listeners. This 240-page book covers 1931 and 1932. (Author's collection)*

was the early style of friendliness and comfort which gave him his faltering start. This was replaced by a technique that had far more mass appeal—a voice that was a strident, rasping and coarse brogue, one that delivered his thoughts in a style that was the epitome of street-corner rabble-rousing.

### **Change of Support**

It didn't take very long before Father Coughlin grew weary of Roosevelt. By 1934 he criticized FDR for threatening to veto a soldiers' bonus. He also shifted his position from being pro-labor to one which was openly critical of unions. Roosevelt was viewed as Coughlin's arch enemy within a short period of time, and Coughlin referred to FDR as "the scab President" and also "the great liar and betrayer."

One would think that such oratory would have angered Coughlin's audiences, but the more vitriolic he became, the more the listeners supported him. To be sure, his speeches and style of delivery were tailored to exploit the anxiety, desperation, and anger of a nation with 15 million unemployed. Coughlin's words were dripping with emotion, bigotry, and hate, and they were mired in political and economic ignorance. A popularity poll taken in 1934 showed that the controversial Coughlin was second in national popularity and power only to Roosevelt himself. His mail was running at a quarter of a million letters a week and it required more than 200 secretaries to process it all. His staff included New York bankers and financial advisors and also a Washington investigative team headed by an ex-newspaperman who specialized in muckraking. Coughlin, by then, had also formed his National Union for Social Justice, an organization that expressed support for an assortment of noble-sounding generalities such as "a just, living, annual wage for all labor,"

"Golden Hour of The Little Flower"

## **Radio League of the Little Flower**

Woodward at 12 Mile Road  
Royal Oak, Michigan

### **To Inform You:**

Catholics, Protestants and Jews are invited to join in this movement for truth, charity, liberty of speech and patriotism.

You may enroll your dear departed loved ones as a token of fond remembrance. Have their membership card sent to your address.

Membership holds good for one broadcasting season. The fee for each person is one dollar. This money will be spent in maintaining the Golden Hour of the Little Flower.

If you care to join the Radio League in defending the principles of Christianity and Patriotism, if you care to assist in bringing back to the fold those who have fallen away, you are most welcome in our midst.

Please feel free to write in for a sermon.

Cordially yours,

Rev. Chas. E. Coughlin.

*Membership in the Radio League of The Little Flower cost \$1 per year according to this solicitation card. You could also enroll departed relatives. (Author's collection)*

etc. Some observers were heard to note the curious similarity of the name of Coughlin's group to that of national socialism, better known as the Nazi Party. Nevertheless, the NUSJ had eight million members by 1935.

By this time, Coughlin was riding the crest of the wave and felt too confined by his Sunday afternoon schedule, which was not broadcast between Easter and the middle of October. How were his listeners to know what he was thinking during those months of the year? Might they forget about him? How would he continue to keep the necessary funds coming in if his presence was not in evidence? He took his problem to Leo Fitzpatrick at WJR and Fitzpatrick had an answer.

Fitzpatrick sketched out a plan he called "The Paul Revere" concept, which would place Coughlin back on the air once per week, at midnight, for a half-hour broadcasting session. These programs would be aired only between Easter and mid-October while the regular programs were off the air, would use the same mini-network employed for the regular fall/winter broadcasts, had the advantages of being cheap to place on the air (since they were in the middle of the night), and would also be received over great distances because of radio propagation characteristics at night. Coughlin im-



**Shrine of The Little Flower**  
National League of The Little Flower

WOODWARD AVENUE AND TWELVE MILE ROAD  
DETROIT, (ROYAL OAK,) MICHIGAN

REV. CHAS. E. COUGHLIN  
PASTOR

April, 1932

"The Golden Hour of the Little Flower"

Alice Flynn  
Stoughton, Mass.

My dear Friend:

While mailing you this book, which I trust and hope you will enjoy, I want to add this little note.

Its main purpose is to thank you for the friendliness and consideration which you have extended not only to the "Golden Hour" but to me personally during the broadcasting season.

Let me assure you that although I shall be denied the privilege of visiting you through the medium of your receiving set during the summer Sunday afternoons, nevertheless I shall make it a point to remember you and your loved ones in my prayers here at the Shrine.

If the tremendous expense entailed both in the broadcasts and the printing of this book cannot be shared by you in a financial manner because of the many exactions upon your purse, nevertheless I know that I can depend upon you to say even a little prayer for me sometime at your leisure.

God bless you and keep you.

Sincerely yours,

*Chas. E. Coughlin*

CEC:DR

All books ordered from Father Coughlin arrived accompanied by a personally signed letter gently requesting funds to help finance his broadcasts. (Author's collection)

mediately liked this idea because he did not want to be off the air with a presidential election coming up in 1936 and so much left to say about Roosevelt.

Roosevelt was attacked more venomously than ever, with Coughlin constantly charging that FDR had betrayed the nation by "not driving the moneychangers from the temple," by complaining that Congress had turned over all of its lawmaking powers to FDR, and by making vaguely anti-Semitic remarks which seemed to include Roosevelt within their scope. He was also berating Roosevelt for not considering that any adherence to decisions of the World Court would be "treason."

**The Good News/Bad News**

By 1936 the attacks upon Roosevelt had been stepped up considerably and Coughlin decided to form an alliance with two other

radical demagogues for the purpose of forming a political party to oppose Roosevelt and the Republican candidate, Alf Landon. Coughlin's two partners in founding the Union party were well known to the public—Rev. Gerald L. K. Smith and Dr. Francis Townsend. A party convention was planned for August in Cleveland.

That convention coincided with what must have been viewed by Coughlin as a wrench in his gears—his mini-network evaporated right under his nose. Broadcast schedules of the day show that as of August, Coughlin was no longer broadcasting over his regular network and had been placed in the position of establishing new stations. A few local outlets were lined up, but nothing as formidable as in the past.

Coughlin's partners in the Union Party were no less controversial than was the Radio Priest himself. Gerald L.K. Smith was a

former Huey Long lieutenant who had taken over Long's Share-the-Wealth movement ("Every Man a King") when Long was assassinated. Smith's philosophy (via Huey Long) was that the government should take all of the riches away from the Morgans and the Rockefellers so that it could be distributed equally among the masses—a scheme he said would give every family head a guaranteed income of \$2,500 per year, a debt-free home, a car, a radio, and a life-long pension at the end of his working days. Smith was also an avowed anti-Semite and all-around racist.

Townsend, a tall, rail-thin, and gaunt 70-year-old retired physician had a dream of his own to hawk. His dream was called the Townsend Plan, which was formulated under the corporate title of Old Age Revolving Pensions, Ltd. Townsend's proposal was to add certain taxes to business transactions which would enable the government to pay \$200 per month to all persons over the age of 60. He had amassed some five million dues-paying members into the OARP, which was supposedly lobbying for legislation to make his plan a reality. A congressional inquiry into Townsend's organization, however, revealed that it was primarily a money-making scheme that gave a gold lining to the pockets of Townsend and a few close associates. Townsend viewed the attention given his business affairs as a personal hostility directed towards him by President Roosevelt and vowed to present a candidate to run against FDR in 1936.

The Coughlin/Townsend/Smith Union Party ran North Dakota Congressman Wil-

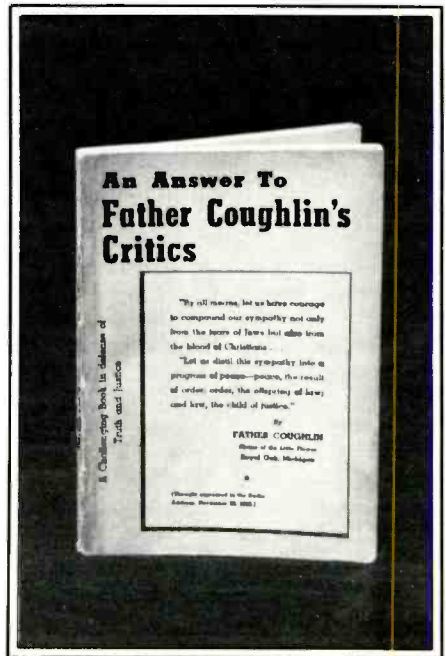

This 164-page book "by Father Coughlin's Friends" was obviously written by Coughlin himself. It was intended to justify statements he made that were perceived as pro-Nazi and anti-Semitic. By the time the book appeared, he had already been removed from the airwaves and was on the road to obscurity. (Author's collection)

liam Lemke in the 1936 presidential election. To say that Lemke received a stunning defeat would be a gross understatement. Roosevelt won the most sweeping electoral victory in modern history, carrying every state but Maine and Vermont. Roosevelt received 60.8% of the popular vote. Landon became a laughing stock when he received 36.5% of the vote, so Lemke's 2% showing made the Union Party and its founders look all the worse, especially since they didn't receive even a single electoral vote. In Alabama, Lemke received only 549 votes, and that was 130 votes less than the Communist Party candidate amassed. In both Tennessee and Virginia, Lemke received only about one third of the votes cast for the Prohibition Party candidate. In Arkansas, Lemke received only 4 votes as opposed to 164 votes for the Communist Party candidate. Coughlin viewed these results as both humiliating and embarrassing and it made him angrier than ever, not only about Roosevelt, but also about what he perceived as "Jewish control of the media," which he blamed for whittling down his ability to broadcast over his once-influential radio network. His oratory then took a much more blatant anti-Semitic course than ever before.

### Changes And A Turning Tide

Early in February of 1937 Coughlin had made plans to get back into radio on a large scale and had been in contact with the newly formed Mutual Network about buying time for a broadcast to be aired at 8 p. m. on Sunday nights. This was a prime time slot on radio's best night of the week. The Mutual Network's schedule published in April, 1937 listed Father Coughlin for 8 p. m. Sundays, but the listing was removed the following month and never appeared again. Obviously Coughlin's plans with Mutual fell through and he was stuck with his existing reduced coverage.

Support for Coughlin, however, had begun to erode after the 1936 election debacle and the negative comment from Catholic leaders that he had long been receiving was continuing to intensify. He was denounced by Cardinals Mundelein (Chicago) and O'Connell (Boston), as well as New York's ex-Governor Al Smith. In 1937, his immediate superior, the Archbishop of Detroit, rebuked him in an action that was fully approved by Pope Pius XI through his Apostolic Delegate in America. If anything, such actions only caused him to become more inflammatory in his oratory, and more acrimonious in his anti-Semitic pronouncements. Anti-Semitic commentary seemed to have become a major content of his broadcasts.

On November 20, 1938, Coughlin delivered a radio address in which he made the claim that virtually all of the 59 members of the Central Committee of the Soviet Communist Party were Jewish and that "Jewish money" financed the Russian Revolution. He went on to say that because communists and Jews were essentially one and the

same, the Jews were actually getting just what they deserved at the hands of Hitler. The aftermath of this broadcast was a storm of outrage and many persons of good will who had been able to find one thing or another to support in Coughlin's earlier statements could no longer justify or tolerate being associated with him. It seemed to many that since the Depression had ended, Coughlin could get no further mileage out of his old familiar targets, so he figured to refuel his engine by exploiting an alternate or replacement target, one which had been workable in the past, one for which the Nazis had done some new groundwork.

The November 20th broadcast was more than most broadcasters in his small radio network could stomach, and they began refusing to carry Coughlin's program. This only added more sparks to his oratory. In 1940 he was finally forced off the air by pressure from his church superiors, public outcry that he was pro-Nazi, and a lack of funds. Deprived of his broadcast pulpit, he nevertheless continued on from the pulpit of The Shrine of The Little Flower in Michigan and by means of his publishing empire.

This same year, the Radio League of The Little Flower published a 164-page book called *An Answer To Father Coughlin's Critics*, by *Father Coughlin's Friends*, obviously written by Coughlin himself. It was an attempt to explain and justify his notorious November 20, 1938 broadcast. It contained the most violently anti-Semitic material he had yet offered, but it was too late. His influence had slipped to the point where there were very few who were interested in the once-beloved Radio Priest and what he had to say. In 1942 his magazine, *Social Justice*, was banned from the mails because it violated the Espionage Act. It was the final blow to the man who, only eight years earlier, was second in popularity to the President.

Coughlin continued to deliver his ser-

mons from the pulpit of Little Flower until he retired in 1966 at the age of 75. Upon his retirement, he complained about the "atheistic teachings" of groups such as the Black Panthers. He was particularly annoyed by radical activist priests like The Berrigans, although he observed that it had "become fashionable for priests to be activists." He added that he recognized that he was a "pioneer" in this area.

A few years later, Coughlin died in relative obscurity.

### The Legacy

One cannot help but look back on the rise and fall of Father Coughlin, The Radio Priest, and speculate upon his original motives. Were they innocent enough at the beginning but, through a series of isolated events, ended up disintegrating into a bizarre nightmare of bigotry? Or was his early pastoral image only a superficial mask that hid a power-hungry man who was destined to become the prophet of hate?

English clergyman Caleb C. Colton (1780-1832) observed, "Power, like the diamond, dazzles the beholder, and also the wearer; it dignifies meanness; it magnifies littleness; to what is contemptible it gives authority; to what is low, exaltation." Maybe this was true in the case of Father Coughlin. The man just couldn't handle the power generated by his own oratory and it ran away with itself once it was amplified by a national radio network. Be that as it may, Coughlin had a silver tongue and, for better or worse, he must certainly be regarded as the first person to have fully mastered the potentials of radio broadcasting as a means to attain immense personal power.

Many others have come along since the time of Father Coughlin and have mastered the art of communicating to the plateau wherein they have achieved enormous per-

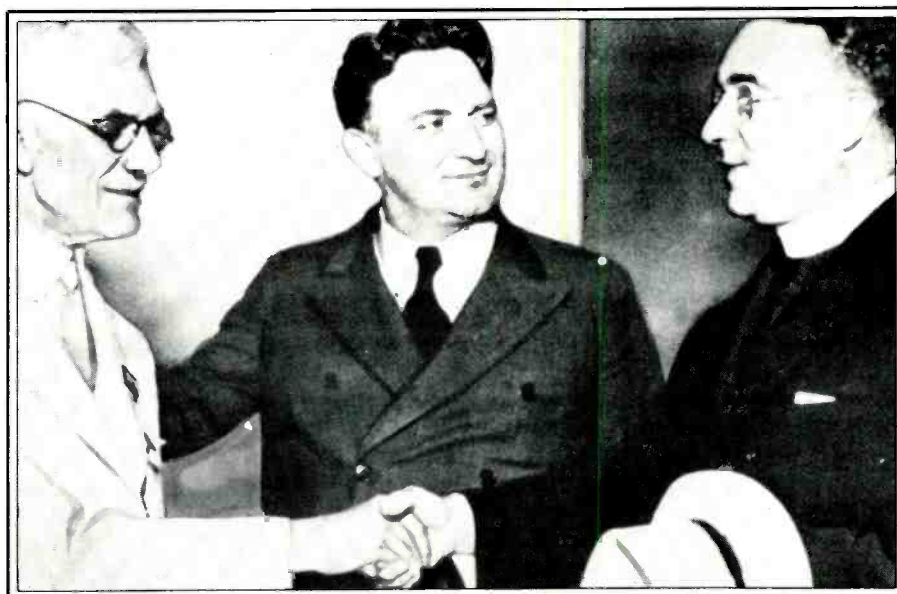

This photo shows (left to right) Dr. Townsend, Gerald L.K. Smith, and Father Coughlin at the 1936 Union Party convention at which The Radio Priest delivered a scathing attack upon President Roosevelt.



## Table I

Father Coughlin's 27-station independent network (as of 1935)

KTSP	St. Paul, MN	1460 kHz	10 kW
KWK	St. Louis, MO	1350 kHz	1 kW
WCAO	Baltimore, MD	600 kHz	500 w
WCAU	Philadelphia, PA	1170 kHz	50 kW
WDRC	Hartford, CT	1330 kHz	1 kW
WEAN	Providence, RI	780 kHz	500 w
WFBL	Syracuse, NY	1360 kHz	1 kW
WFEA	Manchester, NH	1340 kHz	500 w
WGAR	Cleveland, OH	1450 kHz	500 w
WGR	Buffalo, NY	550 kHz	1 kW
WHB	Kansas City, MO	860 kHz	1 kW
WHO	Des Moines, IA	1000 kHz	50 kW
WICC	Bridgeport, CT	600 kHz	1 kW
WIND	Gary, IN	560 kHz	1 kW
WJAS	Pittsburgh, PA	1290 kHz	1 kW
WJJD	Chicago, IL	1130 kHz	20 kW
WJR	Detroit, MI	750 kHz	10 kW

WLBZ	Bangor, ME	620 kHz	500 w
WLW	Cincinnati, OH	700 kHz	50 kW
WMAS	Springfield, MA	1420 kHz	100 w
WNAC	Boston, MA	1230 kHz	1 kW
WNBH	New Bedford, MA	1310 kHz	100 w
WOC	Davenport, IA	1370 kHz	100 w
WOKO	Albany, NY	1420 kHz	100 w
WOL	Washington, DC	1310 kHz	100 w
WOR	Newark, NJ	710 kHz	5 kW
WORC	Worcester, MA	1280 kHz	500 w

### Stations added by early 1936

KFEL	Denver, CO	920 kHz	500 w
KNX	Hollywood, CA	1050 kHz	50 kW
KSFO	San Francisco, CA	560 kHz	1 kW
KVOD	Denver, CO	1500 kHz	100 w
WATR	Waterbury, CT	1190 kHz	100 w
WISN	Milwaukee, WI	1120 kHz	250 w
WLLH	Lowell, MA	1370 kHz	100 w
WRDO	Augusta, ME	1370 kHz	100 w

sonal popularity, power, and influence in respect to the public. People such as Walter Winchell, Arthur Godfrey, Norman Corwin, Dave Garroway, Bishop Fulton Sheen, Johnny Carson, Lowell Thomas, Rev. Jim Bakker, Walter Cronkite, Will Rogers, H.V. Kaltenborn, Mary Margaret McBride, Raymond Graham Swing, Edward R. Murrow, and Gabriel Heatter (to name only a few) proved that, via broadcasting, one's name might become a household word. They did it while maintaining a firm grasp upon reality and a healthy rapport with the public, each with a distinctive and unique personality and style. Nonetheless, when matched up against Charles E. Coughlin, none ever ap-

peared in a national poll as second to the President in popularity and power.

Still others have apparently seen the power that Coughlin was able to achieve—even for a relatively brief time—by the radical methods he employed, combining a gift for oratory with divisiveness, innuendo, hate, and the art of polarization. Despite the fact that the man's own abilities later turned against him, some have apparently used Charles Coughlin as an inspiration for their own activities. Even today such people are attempting to catch the ear of the public. Charles Coughlin remains as one of the best examples of broadcasting used as a tool of personal and political power. **PC**

### Additional Reading

*The People's Almanac*, by D. Wallechinsky & I. Wallace, Doubleday & Co., 1975, pages 1278-9.

*The People's Almanac #2*, by Wallechinsky & Wallace, Bantam Books, 1978, pages 732, 738.

*Tune In Yesterday*, by J. Dunning, Prentice-Hall, 1976, pages 196-8.

*Fads, Follies, and Delusions of The American People*, by P. Sann, Crown Publishers, 1967, pages 87-94.

*A Pictorial History of Radio*, by I. Settel, Grosset & Dunlap, 1960, page 77.

*Radex Magazine*, various issues 1926 to 1940.



# CAN YOU?



- Electronically listen thru any wall?
- See in the dark cheaply?
- Read thru an envelope with a \$1.00 chemical?
- Obtain UNLISTED TELEPHONE NUMBERS?
- Open virtually any LOCK OR SAFE in seconds?
- Ditch or tail anyone?
- Beat the lie detector and the PSE?
- Run a driver's license/vehicle check?

- Trace anyone, anywhere?
- Save 30% 500% on the best surveillance gear?
- Get birth death and real property records?
- Run a 50 state credit check?
- Alter common objects into surveillance gear?
- Beat private detectives at their own game?
- Perfectly scramble any conversation?
- Defeat bug and recorder detectors?

*The First Encyclopedia Of CIA Type Tricks*

## HOW TO GET ANYTHING ON ANYBODY

— LEE LAPIN —

Can 10,000 private investigators, police chiefs, intelligence agents (from both sides of the fence), embassies news reporters and the internal security forces of several mid-eastern countries all be wrong?

"... The most dangerous book ever published," -NBC newscaster, "one hell of a book, for the first time ANYONE can access the secret data banks and devices of the sophisticated powers"-National News Service, "the private eye's bible", Association of Private Investigators, plus rave reviews in everything ranging from consumer publications to Police Times.

NOW AVAILABLE TO THE GENERAL PUBLIC!! Now you can actually understand/use or protect yourself from becoming a target of any intelligence campaign. Hard-and fast data from skip tracing to state of the art surveillance!!!

At Better Bookstores Everywhere - OR

## ORDER TODAY BY MAIL OR TOLL FREE TELEPHONE!!

VISA MC ORDERS ONLY 800-345-8112 in PA 800 662 2444 or mail \$29.95+\$4 00 postage to Auburn-Wolfe Co. Box 623 Holmes Pa 19043 Dept 50.

# PRODUCTS

## REVIEW OF NEW AND INTERESTING PRODUCTS

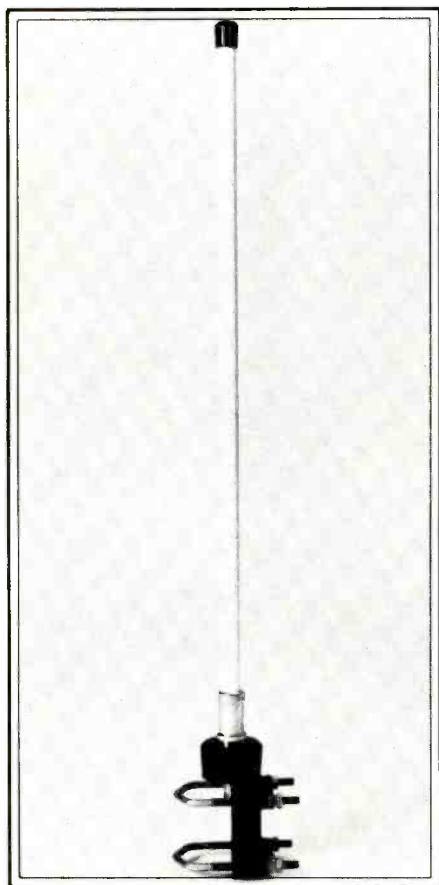

### 3dB Gain Base Station Antennas

Additions to the CELWAVE BA series of VHF and UHF omnidirectional base station antennas featuring 3dB gain have recently been announced.

CELWAVE says antennas in its BA series are constructed of light, durable fiberglass. Unique mounting hardware permits placement of feed cables inside or outside a support pipe.

The manufacturer, successor to the former Phelps Dodge Communications, Co., notes that its new antennas, designated the BA 1312 and BA 6312 series, have wide 4% and 5% bandwidths within a large frequency range.

The BA 1312 series offers frequency bands of 149-155 MHz, 155-163 MHz, and 163-171 MHz. Frequency bands in the 6312 series are 449-467 MHz, 467-485 MHz, and 485-503 MHz. The company says other frequency bands are available on request, and shipping lead time on these antennas is relatively brief because of their stocking status. Antennas in the BA 6312 series are shipped by U.P.S.

Additional information is available from CELWAVE, Route 79, Marlboro, NJ 07746, telephone (201) 462-1880, or circle number 108 on the reader service card.

### Transmitter (Bug) Detector

For those who are concerned that their home, office, or car may be bugged, Capri Electronics introduces the TD-17 Transmitter Detector. Its wide frequency response (1 MHz to over 1,000 MHz) allows the TD-17 to detect virtually all RF transmitters (bugs) commonly used for surveillance purposes.

In use, the TD-17 warns of the presence of a nearby RF transmitter when the RF Alert LED turns on. A flashing Range LED and audio tone give an indication of the distance to the bug. The Sensitivity control, used in conjunction with the two LEDs, helps in quickly zeroing in on hidden bugs.

The hand-held TD-17 weighs less than 7 oz. and is housed in a high-impact plastic case. Priced at under \$200, the unit comes complete with battery, antenna, and instruction manual.

For additional information, contact Capri Electronics, Route 1, Canon, GA 30520, (404) 376-3712, or circle number 104 on the reader service card.



### King Radio Announces VHF Portable Radio Line

King Radio, Mobile Communications Division, announces a new line of synthesized portable two-way radios. All models will feature Bandtrac tuning which allows the radio to tune itself automatically to any frequency in the band. Unlike the typical "wide band" approach, King's Bandtrac feature retunes the radio for each frequency. No degradation in specifications will occur with up to 26

MHz between frequencies. All models can be programmed without any additional electronics or specialized programming equipment.

Most popular options are already built in to each radio, including: Code Guard (CTCSS), Digital Code Guard (CDCSS), Scan, Priority Channel, and Time Out Timer. Once one unit has been programmed, a cable can be attached to a second King portable and pressing the download button will "clone" a second radio with the same programming instructions.

A unique battery saving circuit allows this synthesized portable to achieve a low 11 ma standby current drain. In addition, a choice of twist-off battery packs offers increased capacity for higher duty cycles or extended use between charges.

The new King radio line will make extensive use of surface mounted components. This new technology allows drastic size reduction and improved reliability over hand inserted manufacturing techniques.

A complete set of matched accessories will be available. The King portable radio features a universal side plug connector with RF switching. This permits vehicular charger/amplifiers to be used without making more than one connection.

King's initial offering will include radios in the 148-174 MHz bandwidth: 2 watts 2 channels, 5 watts 2 channels, 5 watts 14 channels.

For more information, contact: King Radio Corporation, Mobile Communications Division, P.O. Box 3347, Lawrence, KS 66046, attention Marketing Services Department, or circle number 102 on the reader service card.

PC



# “Spy” Number Transmissions

## Operational Perspectives

BY ROBERT M. DYQUETTA

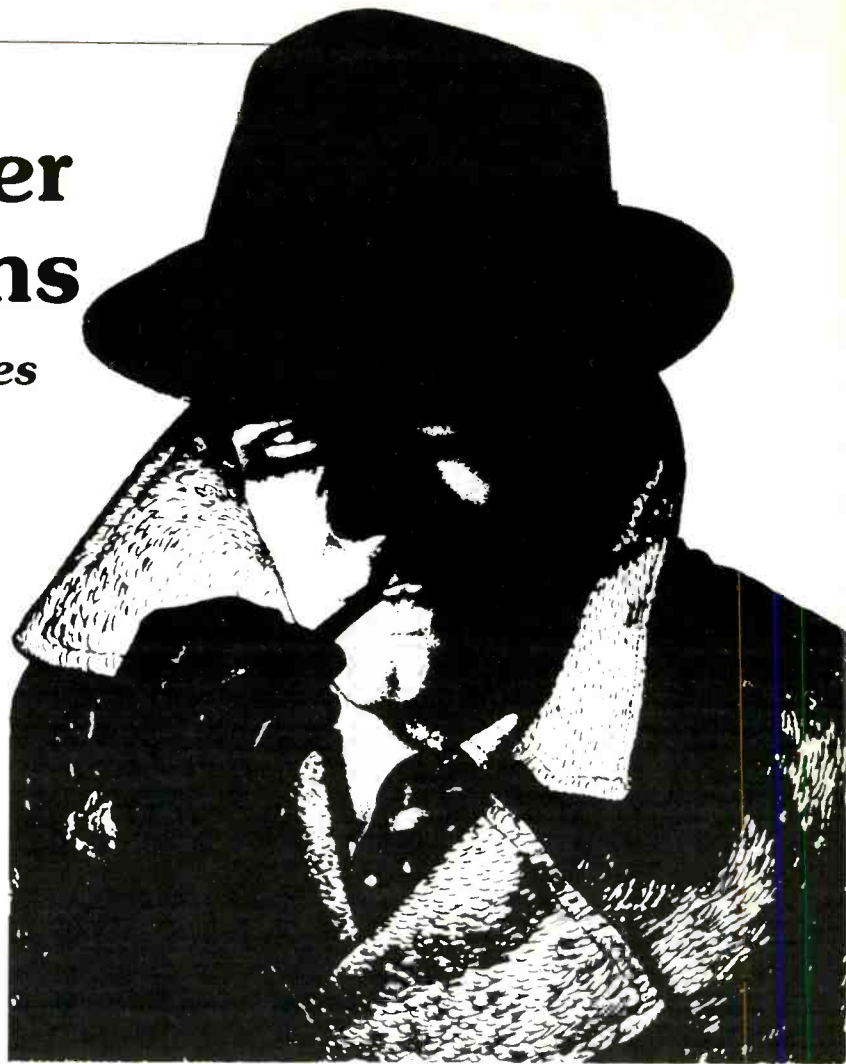

This is the third in a series of articles directed at examining the enigmatic mystery of the number transmissions. All along, the primary emphasis has been concentrated on the 4 and 5-digit SS/YL transmissions, rather than to take on the entire complex spectrum of number transmission types. There are many theories and opinions about them, and it was via the May and August '84 POP'COMM articles that a portion of the unresolved mysteries were addressed in print. The previous articles were intended to be thought provoking, presented in what is known as brainstorming. This was accomplished by taking opinions of many investigative number buffs and delivering them to you in the form of a round table exchange of ideas. Subsequent follow-up discussions re-evaluated and refined some of the brainstorming possibilities, and this led to the exploration of the “system” being employed by the 4 and 5-digit transmissions.

The bulk of this article is therefore an examination and evaluation of the cryptographic/operational aspects of these two number types. It should be noted that this examination is a by-product of extrapolation. Not only were the clues provided by bits and pieces of monitored number transmissions utilized, but also brought into play were the known characteristics of governmental military operations. What developed out of this was a plausible scenario.

As we are now aware, the 4-digit SS/YL transmissions originate from a facility near Remington, Virginia. This facility is only one of several within a large U.S. government-run complex, whose nominal headquarters is located in Warrenton, Virginia. Those whose trivia interests include U.S. intelligence know this area as the Vint Hill Farms Station, SIGINT facility. This is the east coast U.S. Army intelligence communications intercept station, which works for and with the National Security Agency. The dis-

covery of transmitting facilities involved in number transmissions at a complex which has a primary intelligence function leaves little doubt as to the general purpose of the 4-digit SS/YL transmissions. It can be assumed that number transmissions are “operational” activities, and the agency responsible for “active” intelligence matters is the Central Intelligence Agency.

Likewise, enough information now supports the FCC statement that the 5-digit SS/YL number transmissions do indeed come from Cuba (in the vicinity of Havana). We can therefore draw another conclusion—that this operation is a CIA counterpart. This would be under the direction of the Komitet Gosudarstvennoy Bezopasnosti (the KGB) operating through its Cuban intelligence surrogate, the Direccion General de Inteligencia (the DGI).

For years, many number buffs have held to the simplistic idea that these number transmissions were “spy” (intelligence) operations. The discovery of the 4-digit/Warrenton Complex link can now support this simplistic conclusion as being partially or entirely the truth.

In the May '84 POP'COMM article, I stated that there was an odd feeling that we were monitoring just aspects of a single operation. This conclusion is correct, but not because of an implied assumption that both

came from the same source. The reason is that both are utilizing the same basic operational system.

A key to understanding the SS/YL system is to be found in the one common thread they share. That thread is the baffling, Day-Time-Frequency scheduling. As absurd as the DTF patterning is, it offers insight into the system being employed. Granted, the 5-digit transmissions often appeared as if the inmates were running the asylum, whereas the 4-digit oozed professionalism. Yet both have the common DTF thread, so it is only in their conceptual approach that they differ. Here too it must be noted that all of the standard number transmission types (voice & CW) adhere to a DTF schedule. From this, it is reasonable to assume that the entire numbers fraternity are operated by just a very few primary sources. If this assumption were false, then there should not be this common DTF trait.

Cryptography, the art of secret writing, has been with mankind throughout history. The Roman Empire and its contemporaries utilized it, with the simple character for character substitution system of—A equals J, B equals R, and so on.

Due to the prevailing realities during that era, two critical factors were not pivotal. Those factors were time and bulk usage. Often, messages took days, weeks, or months

(Authors note: In the magazine business, it may take a few months after an article is submitted before it appears in print. Hence, both of my previous articles were written before the revelations concerning the 4-digit/Warrenton Complex became known.)

to make the rounds, and it would not be until more sophisticated communication mediums were developed that the time/bulk factors played a decisive part.

By the Middle Ages, cryptography was firmly established as a hand in glove adjunct of political intrigue, as well as its primary application in the military arena. More and more complex and convoluted ciphers were developed, for as it turned out, anything devised by the mind of man could be unraveled by another human mind.

Up to this point, ciphers were of the paper and pencil variety. They all had obvious weaknesses, yet the time/bulk factors were still of minimal importance.

The industrial revolution gave birth to the machine age, and eventually mechanical cryptographic devices made their appearance. During this era, wire (telegraph) communications came into being. It is to be noted that the telegraph code is, in effect, a simple substitution cipher based on combinations of long and short electronic pulses equaling specific character elements. Cipher machines and the advent of wireless communications were combined and refined, reaching their zenith during World War II. Now the time and bulk considerations became critical, as radio allowed for instantaneous message exchanges, and war-time necessities required voluminous amounts of encrypted type traffic.

This brings us up to the present era. Today, during any given 24-hour period, a staggering amount of encrypted traffic is carried out via the radio medium. This enormous utilization of cryptography, therefore, places a heavy demand on those who develop cipher systems. Complex ciphers were no real problem in the pre-radio era, but the now critical time/bulk factors placed a premium on the best possible utilization of crypt practices and operations.

The basic requirements for a modern cipher system (in our numbers context, a system that is heavily used, not necessarily involved with top secret material, yet secret—in other words, a field use type cipher system) are:

- A) Simplicity—both in encipherment and especially decipherment
- B) Ability for the system to have almost unlimited variations in order to handle the sheer bulk needs
- C) High level of security making it almost impossible for any unauthorized parties to “crack” it

There is one cryptographic method that fulfills these contradictory needs, but it was not until the advent of computer technology that the system could be utilized to its peak potential.

There are four basic component parts of a coded message:

- 1) the plain text message itself
- 2) the “key” or encoder by which the plain text is converted into a disguised message
- 3) the resulting enciphered text that is transmitted
- 4) the reverse use of the key to decipher, to obtain the plain text

A - 01	N - 14	1 - 27
B - 02	O - 15	2 - 28
C - 03	P - 16	3 - 29
D - 04	Q - 17	4 - 30
E - 05	R - 18	5 - 31
F - 06	S - 19	6 - 32
G - 07	T - 20	7 - 33
H - 08	U - 21	8 - 34
I - 09	V - 22	9 - 35
J - 10	W - 23	0 - 36
K - 11	X - 24	
L - 12	Y - 25	
M - 13	Z - 26	

A key that is simple to develop and use, that has almost unlimited variations within itself, and is for all practical purposes, secure, has been known by several names. For this article we will use the designation “Random Numerical Key.” As the name implies, it is a purely random association of numbers.

The most efficient utilization of the RNK is on a 2 for 1 basis . . . a two-element encoder key (2EK) equaling one plain text character. In the August '84 POP/COMM article, I gave a representative example of this via the phrase code. In the technique, a phrase and likewise the plain text message are converted into their progressive numerical equivalents. This is illustrated in Table A.

You now have 36 two-digit combinations, one for each letter and number. A disadvantage is that the encoder key utilizes only 36 combinations. This limitation can be reduced by assigning a 00 to 99 sequence. This will give each character three variable double numbers, but as you can observe, 36 multiplied by 3 equals 108. So, we eliminate 8 of the least used letters to conform to a 00 to 99 configuration, as shown in Table B.

A weakness of the phrase code is the phrase itself. It is made up of recognizable and therefore definable words, phrase/sentence patterns. The computer doesn't require this. It is merely programmed to randomly select numbers ranging from 1 to 0 for each 2EK unit. Therefore, in a 2 for 1 arrangement, the computer has a one in ten and one in ten assortment per 2EK. Following computer logic, each 2EK is different from the other, making every 2EK a separate and self-contained cipher in itself. This makes unauthorized deciphering an impossible task since there is no pattern in the computer generated RNK sequence. Without knowing the precise numerical alignment, this simple system defies decipherment attempts (by unauthorized parties) within practical time frame restraints.

The ultimate security measure is to use the RNK encoder sequence only once. Only with computer assistance can such a sheer bulk of RNK sequences be developed to keep pace with the required use. An application of the RNK principle has a well-known and infamous example—the one time code pad.

The 2 for 1 RNK arrangement is a mathematical wonder. Each 2EK has a constant

1 to 100 ratio, with the 2EK preceding and following it. In other words, we are dealing with multiples of 100 plus 100 plus 100 and so on, which continues in this fashion throughout the length of the RNK encoder sequence.

A straightforward method to devise an RNK encoder sequence is to utilize all 100 numerics, 100 times. This gives one, 10,000 total numerics. Applied to the 2 for 1 concept, you have 5,000 2EK units. This is equal to 2,500 4-digit groups or 2,000 5-digit groups.

Now this is just one of one hundred variables. In any given 100 numerical sequence, a specific number (say 78) will appear only once per 100. But the computer isn't locked into this logic. It can utilize “78” no times, or as many as its electronic logic devises. So, in actuality, we are dealing with 100 numerics, 100 times, times 100 combinations, or a grand total of one million numerics (500,000 2EKs).

The 2 for 1 RNK system, utilizing the encoder sequence only once, is both simple to use, applicable to bulk usage requirements, and has an almost infinite number of variable combinations. Today, random numerical encoder keys and its similar alphanumeric counterpart are used quite extensively both in diplomatic and military arenas. It is logical to assume that the RNK system is the basis for both the 4 and 5-digit SS/YL transmissions.

In reference to the 4-digit SS/YL, we can apply logic to the use of the one time code pad system. We know that the 4-digit gal has never used more than 300 groups in any given transmission. Logic would say that the decipherment pad has pages that each contain approximately 300 4-digit groups. This though makes for a big pad. What is more rational is that each page may contain, for example, only 25 4-digit groups. To use it, the agent deciphers by going consecutively from the first through the twenty-fifth group. If more of the message is left over, the agent returns to the first group and deciphers in the same progressive manner. This is still a very secure system, for the RNK encoder se-

A - 00-36-72	S - 18-54-85
B - 01-37-*	T - 19-55-86
C - 02-38-73	U - 20-56-87
D - 03-39-74	V - 21-57-*
E - 04-40-75	W - 22-58-88
F - 05-41-76	X - 23-59-*
G - 06-42-77	Y - 24-60-89
H - 07-43-78	Z - 25-61-*
I - 08-44-79	1 - 26-62-90
J - 09-45-*	2 - 27-63-91
K - 10-46-*	3 - 28-64-92
L - 11-47-80	4 - 29-65-93
M - 12-48-81	5 - 30-66-94
N - 13-49-82	6 - 31-67-95
O - 14-50-83	7 - 32-68-96
P - 15-51-*	8 - 33-69-97
Q - 16-52-*	9 - 34-70-98
R - 17-53-84	0 - 35-71-99



quence remains unknown to unauthorized parties. From a pad page standpoint, this allows headquarters to devise 10,000 individual pages, with each one having a totally different set of 25 4-digit groups. Likewise, this methodology can be applied to its 5-digit counterpart.

If the RNK system is being used by the 4 and 5-digit transmissions, then the perplexing DTF is not such a ridiculous procedure. No intelligence operation would so openly transmit if it wasn't certain that its messages would be very secure from counter-intelligence decipherment. Only by utilizing the one-time RNK system could such an operation be permitted to be carried out in such an overt and blatant manner. But why utilize a rigid DTF? To answer this, we must use a bit of cloak and dagger logic.

Part of the intelligence game is to deceive your opposition. If you are conducting a radio link network with your field agents, there are things that you don't want counterintelligence to know while you are doing it.

A) You must be able to regularly contact a specific agent without permitting counterintel to ascertain who, where, or even when.

B) Likewise, you must use methods that won't betray the total number of operatives in your radio link network

C) Your transmission procedures must be designed so that when your agents do monitor, their various activities won't draw unwanted attention.

The DTF practice allows this game to be carried out. Let's illustrate this by a hypothetical example:

Headquarters has a daily 8-hour radio broadcast routine, during which time it transmits two different messages per hour. So day after day, headquarters will keep to this schedule of 16 total messages. This would be regardless of how many agents are actually being contacted.

From the field agent point of view, it is quite absurd to monitor all transmissions, 8 hours per day, day after day. Just imagine it. In any given location, a certain individual would disappear for the same 8 hour period each and every day. Admittedly this could be accomplished, but it is not very logical. History has shown us that the most successful agents were those who could blend into the society. An agent living a seemingly anti-social, hermit-like existence would certainly stand out. So, there must be a monitoring routine that will not draw any undue attention to the agent.

The one time code pad (or equivalent) is one part of the system. Its individual pages would not be consecutively numbered for obvious reasons, so the top page could have a 915 designator, the next, 132, 576, 408, and so on. Once used, the top page is destroyed and now 132 is the new top page. Every agent has his own pad, with its own unique series of page designators, and of course, RNK sequences all differ from one another.

It is unlikely that every agent needs be contacted each day. Depending upon their assignment, this could be several times a

week, a few times a month, and so on. Because of the unexpected, it is possible that agents additionally have predetermined "spot check" periods.

What would be the best monitoring routine for a field agent? That of a day/time schedule. An example would be: Monday at 0200 GMT, Wednesday at 0600 GMT, Saturday at 0100 GMT. The exact monitoring schedule would undoubtedly be based on the individual agent's availability to do so without arousing any undue suspicion.

Back at headquarters, the computer memory banks have the agent ident, location, monitoring schedule, and a duplicate copy of his RNK one time code pad, which includes the random page designator sequence. At 0200 GMT on Monday, Agent XYZ tunes up his receiver to whichever frequency he can most easily receive the communications on. He hears "915 915 915, 1234567890," or if employed by the other side, "Atencion 915 30." Since his top code pad page has the 915 designator, the following message is for him. If he heard any other s/on designator, traffic was not for him, so he shuts down and goes about his business (by the way, this could equally be a "her").

Every agent in the radio link follows this pattern. To counterintel, they will monitor and record 16 messages per day, but will have no idea who they are for or how many are valid. In fact, headquarters might not have any agents scheduled to receive traffic on Monday, but nevertheless would still transmit 16 (bogus) messages. This is accomplished by signing on with a designator that HQ knows no agent has for their Monday/time wise monitoring schedule.

In this context, the s/on preamble, used by the 4 and 5-digit transmissions, is a pad page designator and not an agent ident. As stated, if it was an agent ident, all agents would have to monitor the entire 8 hour period to ascertain if anything was for them. With the RNK cipher system, along with an agent callup based on a page designator, day/time tie in, the operation itself is simple, yet very secure.

As we are all aware, specific number transmissions can be repeated daily, weekly, and some over a considerable period of time. This has been a baffling aspect to figure out, but by utilizing the aforementioned concept, these are now sensible. . . they are bogus messages. To be sure, a genuine message will be repeated at least once or twice to insure that if the receiving agent couldn't monitor it during his scheduled period, he could then do so on one of his alternate time slots. But once deciphered, the pad page is destroyed and the message now has no meaning. Because it was to a specific agent, it could be run in other day/time slots as a filler (bogus) message to keep up the 16 per day routine.

A distinct advantage of individualized RNK sequenced pads is that if an agent were apprehended and his code pad taken, all counterintel could do with it was to decipher any forthcoming messages to that agent. Since the RNK sequence is unique, his pad

could not be used to decode any other net traffic. One agent would be lost, but the network would remain secure.

Both the 4 and 5-digit transmissions have one curious transmission. The 4-digit has: "Cinco, Quatro, Cinco"; the 5-digit has: "Atencion # # #" with no group count. Both run this over and over until it is time for the message. Instead, the transmission ends. On the surface it appears that these are "no new message for you" type traffic. Obviously, no new message is being sent, but something specifically is being inferred. These transmissions stand out from the regular group count traffic, so they could be more than what they appear to be.

The 5-digit SS/YL is famous for her "Laurel & Hardy" approach to many transmissions. Some are royally botched up, making it appear that HQ doesn't really care if the message is readable. It could be that HQ knows the message is bogus and therefore adopts a somewhat careless attitude to it. This explanation is plausible, but not a good intelligence practice, nor would such goings on be tolerated. This Laurel & Hardy routine is probably a put on. Those glitches are deliberate, designed to be part of deception gamesmanship.

In the past, some number buffs have noted fluctuations in certain number types. Seemingly for short periods of time, more transmissions were evident. Although the hard data is sketchy, it appears that it was not so much a case of more and different traffic, but more frequencies being utilized. Of course, during some sort of crisis situation, agents probably received a revised monitoring schedule. Overall, long period analysis does support that the various number types do adhere to a predictable DTF pattern with minor, isolated fluctuations.

For the field agent, the simplest and quickest decipherment procedure is the most logical method. The RNK encoder would be built on the 00/99 sequence to obtain the 100x100x100 variable. For the agent, decipherment would be a straightforward, single stage routine utilizing the 01/36 type for plain text equivalents. The RNK is secure enough so there would be no requirement to 00/99 sequence the plain text, nor jumble the plain text character/numerics. Through experience, when an agent deciphers a message and finds 02 05 03 01 18 05 06 21 12, he wouldn't have to look it up to know what it says.

Keeping it simple (for the agent) has obvious merits. Some agents would be recruited from the local area. As such, they would have no formal intelligence operational experience, which includes radio operation/crypto practices. The radio/crypto portions would have to be simple enough to be easily mastered. In addition, the same system would apply to the entire intel network.

Paperwork would be another problem. The one time code pad would be easy to hide if it followed the discussed minimal groups per page method. For a system to use the entire 4 or 5 digits to indicate a single letter, number, word or even phrase means

that the agents would have to possess a large book for deciphering purposes. This is obviously not ideal—nor safe. In addition, the cipher itself would be static, and even with variables it would be vulnerable to counterintel probings.

### Nulls . . .

If the 2-for-1 RNK system is being used, then the 4-digit SS/YL format seems to be a straightforward presentation. Headquarters would know this, so all messages could have pre-positioned numerical nulls (numbers which are bogus) to further frustrate unauthorized decipherment. Even the 5-digit SS/YL could be using the 2-for-1 system and presenting it in a 2EK, 2EK, 1EK and 1EK, 2EK, 2EK sequence. Here too, nulls may be employed (2EK, null, 2EK). The one time RNK system obviates any need for complexity via nulls, but any simple additions that can enhance cipher security might be employed.

Code pads are not the only deciphering medium; a book can be used. In this method, the s/on designator indicates the book page to use. Its text is then converted into the 01/36 alignment, and becomes the decoder key. All paperwork for this is destroyed once the message is deciphered, so there is no evidence lying around; only a book commonly found in the agents area.

Another alternative method is what is known as page positioning. Here there is no RNK system at all. The same initial procedure, as before, is used. Here the sum total of the group is the key; for example, 41035, which indicates the 13th word on the page. This is practical until one realizes that it cannot designate anything beyond the 45th word. This can be modified by having one of the numbers in each group designated to be a multiplier. With the fourth number a multiplier, the 41035 group would equal the 30th word. This system will allow coverage to the 324th word on the page.

These book type methods require that each agent use a different book. Obviously if an agent was caught and forced to talk, counterintel now has the "decoder" and can decipher all messages sent. This could prove catastrophic for the entire agent network.

It is interesting to note that the total number of transmissions made by a particular number type has no bearing on the total number of agents in its network. The 4-digit SS/YL has only one message (plus the repeat) per hour. Over a 24-hour period, only 24 messages are being sent. By contrast, the 5-digit SS/YL may have between one to four per hour. This equates into a 24-hour range from 24 to 96. A generalized evaluation can be made. The limited number of messages sent by the 4-digit type might indicate that most are genuine. The Laurel & Hardy routine of the 5-digit type may be a clue that most are bogus. Deception is an operational procedure, so even this evaluation may have no reality.

When we compare the 4 and 5-digit transmissions, we find many striking similarities. Taking the 4-digit Warrenton findings, we

can assume the 4 and 5-digit types represent opposing intel services. If so, their operational parameters should not be so very similar—but they are.

- A) a distinctive female voice
- B) Spanish language
- C) AM/A3H transmission modes
- D) Initial start times, on the hour
- E) A standardized s/on preamble that always included a 3-digit designator
- F) Messages that are pre-recorded
- G) Message repeats, as a standard practice
- H) Adherence to a DTF schedule
- I) Out in the open, nothing to hide, transmission philosophy

There are differences, but these are more

of a procedural variable rather than incompatibilities . . . 4 versus 5-digits, few versus many frequencies, simlkey versus single frequency, specific arrangement of the s/on preamble, and so on. It is not so much that one is attempting to mimic the other, but rather that both are using a very similar system and their target areas are in the same geographical area.

More people tend to pay keener attention to a female rather than a male voice. Spanish linguistics are used to conform to the predominant language (other than English) in the Americas. This, though, does not indicate that the decoded message is in Spanish. AM/A3H are the easiest transmission modes to tune and can be done so on

# GILFER SHORTWAVE

International Radio Specialists  
31 years serving SWLs worldwide

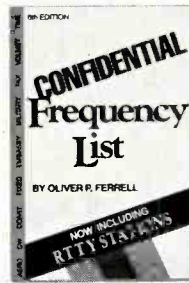

Just off the press — exclusive 6th edition. New "CONFIDENTIAL FREQUENCY LIST" international utilities book. Compiled by O.P. Ferrell of GILFER, this huge CONFIDENTIAL is the ultimate listing for SWL monitoring of sub rosa broadcasts the world over. 336 pages. Fixed, FAX, military, aeronautical, embassy, INTERPOL, press, VOLMET, Coastal, plus hundreds of RTTY stations. All listed by frequency and call sign together with location, power, schedules, RTTY speed/shift, etc. Tune the mystery stations from 4 to 26 MHz, all spelled out in this giant book by the giant in SWL, O. Perry Ferrell.  
**\$13.95 + \$1.00**



"Time Signal Stations" 84 page, 10th ed. lists time measurement stations of the world; address, time, power, diagrams, etc. **\$3.95 + \$1.00**



"Radio Beacon Handbook" 252 pages all known long and medium wave beacons, call signs, frequency, location, target areas. **\$12.95 + \$1.00**



"QSL Address Book" SW 4th ed., 104 pages, 960 SW broadcasters who respond to QSL requests. Who & what to write. **\$6.95 + \$1.00**



"FM Atlas/Station Directory" New 9th ed., thousands of changes, FM maps, directories by geography and freq., formats, etc. **\$7.50 + \$1.00**



### NEW ICOM-R71A DX Machine.

More features, performance and options. FM, AM, CW, USB, LSB, RTTY, 100 kHz to 30 MHz, quadruple conversion, direct feed mixer, 100 dB dynamic range, two independent VFOs, direct freq. entry keyboard, 32 scanning memories, switched preamp, passband tuning, notch, AGC, blanker, plus many options, standard or modified by GILFER.



IRC NRD-515, introduced to U.S. by GILFER. PLL encoder VFO tuning, switchable incremental tuning, fast/slow, auto band switching, 96 ch. memory, AM, USB, LSB, CW, RTTY, standard or modified by Gilfer.



Yaesu FRG-7700. Real performer, realistic price. 150 kHz-30Mhz, digital & analog readouts, clock/timer, 3 AM bandwidths, fast/slow AGC, blanker, optional 12 ch. memory and GILFER mods. for sharper selectivity.

Look to GILFER for Receivers, Accessories and Books. SONY, PANASONIC, SHARP portables for SWLing on-the-go, EAVESDROPPER II, DATONG Antennas and accessories, TELEX and MODUBLOX headphones, HOWARD MILLER and COPAL clocks, ALPHA/DELTA lighting protection and master consoles, books and more.

Call us for the equipment you need at prices you can afford

## GILFER SHORTWAVE

52 Park Ave., Park Ridge, NJ 07656, Ph. 201/391-7887

CIRCLE 60 ON READER SERVICE CARD



inexpensive, single receiving mode type receivers. Initial transmission starts on the hour and conforms to the DTF patterning (an agent doesn't have to remember odd time starts for his monitoring). The 3-digit s/on designator belies that a standardized and somewhat similar system is in use by both. The secure nature of the cipher system allows for the most simple method to transmit messages (right out in the open).

So it is possible that two opposing agencies could utilize the same basic methods. This doesn't fool anyone except the casual monitor, who may believe that both are just aspects of a single operation.

It has been long established that the 4 and 5-digit transmissions are pre-recorded. The female vocalizing the 4-digit traffic, just like her 5-digit counterpart, says everything exactly the same way, every time. Oscilloscope patterns show that (say) "cinco" has the exact same frequency response (whether made years ago or today), and hard copy printout would superimpose over one another precisely. This means that the respective YLs are not voicing each message. Twenty years ago that would have involved making a master tape of all the words and numbers, then electronically inserting, item for item, onto the actual tape that would be transmitted. Today, the voice would be computer synthesized and assembled into the transmission tape or computer memory disk.

Pre-recording allows for the tape to be checked for errors before transmission. It would also preclude any studio facility just a

playback unit at the transmitter site. Hence the agency involved may have no visible presence at the transmitter site.

It must be noted that a pre-recorded message indicates one-way communications. This in itself can suggest orders/instructions. The 5-digit transmissions definitely use a tape playback method, but the 4-digits may not. Transmission analysis indicates that the 4-digit type may be utilizing a direct computer to transmitter method via secure land line links. Some of the regular noises heard, prior to and after the actual transmission, suggest a telephone type interface.

But it is this preciseness of the vocalizations that can suggest an alternative to the scenario we have presented. In effect, they are audio authenticators. When we take into account these precise vocalizations and the Warrenton Complex findings, out of it appears the following.

An alternative method is for headquarters to transmit to centralized receiving stations in foreign countries throughout Central and South America. Considering that this might be in nations that are not friendly to headquarters' government, or otherwise wouldn't be overjoyed at having their internal affairs messed around with, there is only one secure facility that can operate in such an environment—an embassy.

The individual who tracked down the 4-digit transmissions to the Warrenton Complex also ascertained that KKN50 was likewise being transmitted from there. KKN50 is the callsign for the Department of State,

Washington DC. This is a CW transmission, and another numbers type transmission, the CW 4-character type, likewise comes from the complex (the one using the code sequence AUV4E6BDNT).

There are several government agencies that use this facility. It might be coincidental that the 4-digit SS/YL, the CW 4-character, and the U.S. State Department are there, but this does suggest the alternative of a centralized receiving site method.

Vocalizations are interpreted by radio receivers as a pattern of electrical variables. Since the SS/YLs are precise, they form an electronic signature that can be recognized by a computer. Program the designators that your embassy is assigned, link this to a state of the art receiver, and the system can automatically monitor the entire series of transmissions from headquarters. When the computer monitors a signature match for "nueve uno cinco," it records/stores and decodes that transmission. The embassy, (actually its intelligence unit) then decides which of its operatives will get the assignment. The RNK encoder concept would remain. The s/on designator would not be a pad page designator, but might possibly be an ever-changing series of idents for the embassy. The decipherment pad would conform to a code book approach, since concealment would not be a requirement.

It must be pointed out that, unless you were raised in solitary confinement, you are quite aware that intelligence operations are part and parcel of diplomatic activities. Anyone who doubts this just has to check the track record of diplomatic personnel being booted out of a host country for espionage type activities.

Embassies allow for intelligence officers to be easily brought into the host country by giving them a diplomatic status cover. If caught in espionage activities, these individuals don't have to fear interrogation or imprisonment. They can only be declared persona non grata and asked to leave the country. The embassy and its diplomatic compound/residence is strictly off limits to any search. Everything from diplomatic pouches to crates can come and go without being inspected. If there was ever an ideal place to mount peacetime intelligence operations, the embassy is number one on the list.

While we are on the subject of embassies, let me draw your attention to some curious parallels.

The number transmissions coming from the Warrenton Complex have as buddies the State Department and at least two intelligence agencies. The German YL number transmissions have been D/Fed as coming from Nauen, East Germany. This is a large centralized transmitting facility that includes GDR point to point, the DP and ADN (RTTY) news services, and the GDR Ministry of Foreign Affairs (the MFA is the equivalent of our State Dept.)

Unfortunately, no precise QTH data is available on the 5-digit SS/YL transmissions out of Cuba, except that they come from the vicinity of Havana. Just east of Ha-

## FREE FROM SPACE

More than 50 channels of TV.

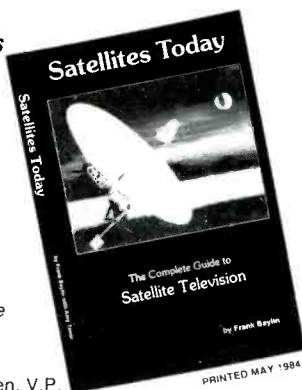

"Should be required reading for the entire industry".

Hal W. Farren, V.P.  
National Micro-Dynamics

### UPLINKS, SATELLITES & EARTH STATIONS LEGALITIES & PROGRAMMING THE PAST, PRESENT & FUTURE

To Order:  
Send \$9.95 for each  
copy of Satellites Today to  
ConSol Network, Box 12098-M  
Boulder, CO 80303

Name

Address

City  State  Zip

INQUIRE ABOUT OUR QUANTITY DISCOUNTS

## Delaware Amateur Supply

71 Meadow Road, New Castle, Del. 19720  
Factory Authorized Dealer! 302-328-7728  
9-5 Daily, 9-8 Friday, 9-3 Saturday

KENWOOD, ICOM,  
YAESU, MICROLOG,  
KANTRONICS, AEA

Order & Pricing

800-441-7008

NO Sales Tax in Delaware! one mile off I-95

Please send all reader inquiries directly.

## FANTASTIC SPACE-AGE ELECTRONICS

LASER WEAPONS, INVISIBLE  
PAIN-FIELD GENERATORS, MORE...

Survival writer discovers...secret sources for laser pistols, listening devices, ultrasonic pain field generators, paralyzing self-defense protectors, true I.R. see-in-the-dark viewers, absolute security systems, bug detectors, voice scramblers, micro-transmitters, electronic tracking devices, ultra-sophisticated detection and surveillance equipment, police broadcast unscramblers, many more too "hot" to print. Send \$1.00 for giant catalogue (get \$2.00 credit) To:  
UNIVERSAL SECURITY, Dept. PC-11  
15015 Ventura Blvd., Ste #1653, Sherman Oaks, CA 91403

CIRCLE 38 ON READER SERVICE CARD

vana is Bauta, an extensive transmitter complex that includes the Cuban point to point network. Taking a wild guess, where do you believe the 5-digit numbers and the Cuban MINREX (Ministry of External Relations—State Dept. equivalent) also come from?

Curious isn't it? Even more curious is that only three locations have been definitely associated with the regular type number transmissions. It may be a possibility that all the regular number types originate from just these three sites.

The embassy tie in is a possibility that cannot be dismissed out of hand. But there is also an intangible yet unsettling feeling when one looks at this State/MFA/MINREX correlation and the very similar operational parameters that the number stations use. Opposing political systems could adopt very similar transmission patterns for their intelligence type operations, but is this the reality?

We are not now implying that the headquarters to field agent concept is incorrect, but certain aspects of it stand on somewhat shaky ground. This therefore promotes another alternative to examine; the transmission parameters are so very similar because the entire numbers fraternity are part of one communications network. If true, then there is diplomatic level activity that has never been explained to the average citizen.

A major portion of this article was devoted to developing a credible scenario for the headquarters to field agent concept. This was primarily because most number buffs believe that this is the reality. The alternatives were presented, not to cast doubt on the main conception, but to inform you that there are viable alternatives. These then could utilize certain aspects of the HQ to agent concept, yet have a different baseline setup or even a totally different ulterior motive.

Let us return to the Warrenton Complex. The disclosure of the transmitter location for the 4-digit SS/YL and the CW 4-character type at a complex which is hip deep in intelligence activities must be regarded as one of the more significant discoveries in the arena of number investigations. The Warrenton Complex has an official government designation of National Communications System. There are several agencies that utilize the NCS facility. Among them are NASA, FAA, General Services Administration, Dept. of Commerce Weather, Dept. of Interior Pacific Island Trust Territory, and the FCC Emergency Action Notification networks. Apparently these only avail themselves of a centralized communications complex and are not part of the number operations. Two other agencies do have an intelligence tie in—the State Dept. Diplomatic Telecommunications Service and the Defense Communications System. Not even hinted at are the presence of Army Intelligence, the DIA, the NSA, and undoubtedly, the CIA. As such, the NCS Warrenton Complex is a major U.S. government monitoring and telecommunications facility.

## HEAR THE NEW BANDS ON YOUR SCANNER



Converts out-of-band signals to vhf or uhf scanner bands. Cables provided. Simply plug into scanner.

### 5 MODELS AVAILABLE:

806-894 MHz New Land Mobile Band  
400-420 MHz Federal Government & FBI  
240-270 MHz Navy/Air Force Fleet Satellites  
135-144 MHz Weather & Geophysical Satellites  
72-76 MHz Industrial & Radio Control

Scanner Preamps also available

**ONLY \$88 + \$3 S & H**

Order by phone or mail. Use credit card, check, COD. Or send \$1 for complete catalog by return mail.

**hamtronics, inc.**

65-B MOUL ROAD  
HILTON NY 14468-9535  
Phone: 716-392-9430

CIRCLE 3 ON READER SERVICE CARD

Within its confines are the representatives of diplomatic, military, and intelligence aspects, all of which are interrelated with national security. It does not stretch the limits of credibility to assume that the number transmissions, likewise, have a national security linkage.

In regards to this, the FCC has apparently modified its policy regarding information disclosures on the number transmissions. Several number buffs have received very interesting replies to their data requests on the 4 and 5-digit transmissions.

The FCC still maintains that the 5-digits are from Cuba. The actual wording is "apparently," "believed to be," "in the vicinity of." No elaborations have been made on the exact location. But other replies have the FCC stating that the number transmissions (in general) are operating in the International Fixed Service bands, and that these stations have the legal right to use various methods to maintain privacy in their communications (encryption of traffic). The FCC can legally refuse to elaborate on these transmissions, for under international accords, nations are to respect the privacy and confidentiality of transmissions made by other nations.

In regards to the 4-digit transmissions, the FCC tactfully suggests that they are authorized, but not under the jurisdiction of the FCC. The FCC has jurisdiction only over U.S. based or U.S. generated radio operations. This regulatory power covers the private, commercial sectors, and certain government agencies. What the FCC has no power over is diplomatic and intelligence radio operations, plus certain military operations. Without making a definitive statement, the FCC leaves it to those receiving their reply to make the assessment.

In any investigation in which more is unknown than known, it is a paramount objective not to trap yourself into accepting a single conclusion, and then trying to fit the bits and pieces to conform to it. Many of you have your own ideas on this complex subject, but in order to evaluate your own conclusions you must take into account and ex-

amine all the other possibilities, even though some may be absurd or illogical. Anything less makes your probing subjective, whereas it should be objective.

It is not the contention of this author to categorically state that the 4 and 5-digit number transmissions are utilizing and practicing the methods described in this article. These are extrapolated hypothesized conclusions, which in their total concept may not be the baseline truth. Nevertheless, it is believed that portions of these assumptions and alternatives are, in fact, a reality.

These three articles have a definite purpose. Its brainstorming approach was designed to give you a wide ranging set of possibilities. You may or may not agree with some of the conclusions, but for many of you, they have provided fresh insights into the numbers mystery. You must look them over and make your own determinations, then follow up with your own line of reasoning. This third article was a perfect example. In some instances, it presented diametrically different conclusions than were found in the first and second articles. This was due, in part, to a reassessment of the clues and an influx of new information.

This is how we search for the truth when it is hidden behind a veil of mystery; adopt a contention, then follow it through. If along the way, something hints at a different possibility, then you modify your direction and go on from there. Evaluate, re-evaluate, qualify, disqualify. It is a tedious process that may not bear fruit. This is a challenge, and only those who can willingly take on the odds stand any chance of succeeding.

In the realm of utility monitoring, the number transmissions have always been the greatest single mystery that has confounded us. Once it was a solid, impenetrable wall, but over the years, cracks have appeared. Those cracks were made by dedicated number investigators. You have an opportunity to widen those cracks even further and bring the truth (at least the basic answers) into the light of day. That is the underlying purpose of these articles . . . to provide you with the incentive to do just that.

PC



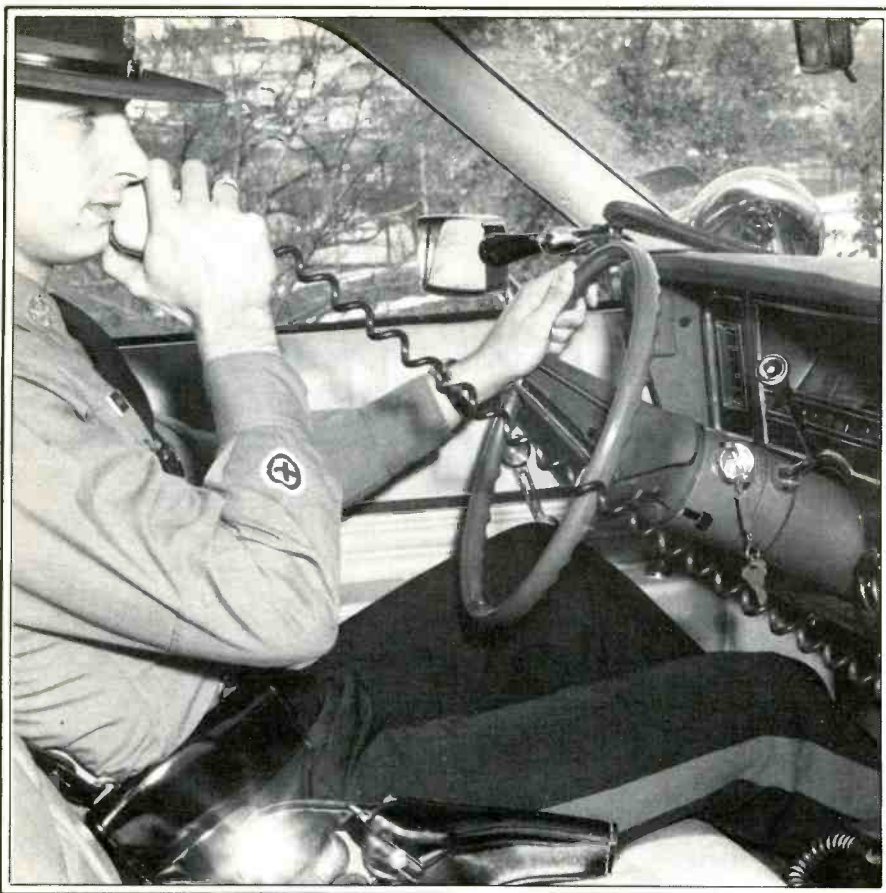

# Police Radio – A Scanner Favorite!

*From Routine License Plate Checks To Major Crimes, Hear It All On A Scanner!*

BY RICK MASLAU, KNY2GL

Scanners weren't invented (by Electra in 1968) just for a lark. They were conceived because, prior to their availability, everybody was monitoring police and fire communications by means of crystal controlled receivers with rotary switching. That meant every time you wanted to hear something that was on a frequency different from the one tuned in, you had to manually click over to another spot on the rotary channel selector switch. Even though this was a nuisance, it was an improvement over the fully tunable VHF receivers that had been in use previously in the 1950's.

Yes, public safety frequency receivers covering the VHF bands were available back in the early 1950's; in fact, when the police began using the VHF low-band (30 to 50 MHz) in those years, they had an audience of folks who wanted to hear what they were saying on the air. And that's the way it's been

for a long time, even back into the 1920's when the police began using communications. In the 1920's the police used frequencies between 1700 kHz and about 2600 kHz. In those days, you could turn on a receiver any night of the week and listen to police dispatchers across the nation, and lots of people made it a habit to do just that—for monitoring police communications has always been a national fascination. It's probably the reason that 90% of scanner owners were originally inspired to go out and purchase one of these electronic marvels in the first place!

There's little excitement that can equal listening in on a detective stakeout, or to the police defuse a hostage situation, or the cops chase a getaway car down a city street or Interstate highway. The whole drama of life is played out on police radio—birth, death, crime, crowd control, undercover

work, even sending an officer to help quiet a family disorder. Metro police departments may utilize large numbers of frequencies, with relay stations, repeaters, hand-held units, and even frequencies used exclusively for data transmission. Of course, these days, law enforcement comes in many shapes and forms—city and town agencies, county agencies, and state agencies—and these agencies even have special frequencies used to intercommunicate with one another for maximum effectiveness.

As time has gone on, agencies have required more and more frequency space and have inched further and further upwards in frequency, past the low band and into the high band, then into UHF, and even into the newer 800 MHz channels in some instances.

Most areas of the country have plenty of law enforcement activity taking place in the 37 to 46, 154 to 159, and 453 to 512 MHz bands. Astute monitors have also realized that there are also police communications, in some areas, to be heard on frequencies allocated to the Local Government Radio Service, the Forestry Conservation Radio Service, the Highway Maintenance Radio Service, and even CB and the 49 MHz no-license bands!

Frequency 155.475 is now available nationwide for use in police emergency communications networks operated under statewide law enforcement emergency communications plans. Frequencies 39.48 and 45.86 MHz are popularly used for intersystem police communications, although some areas have adopted other frequencies for regional or statewide intersystem networks.

Some police departments have been monitored using speech scramblers on certain frequencies or under certain conditions, but the majority of police communications can be monitored "in the clear." There are speech unscramblers available that can be easily used with most scanners, and these have done their job well with the type of simple scrambling commonly used.

## Questions

There have long been questions raised about the moral, legal, and ethical aspects of police monitoring. Since I'm not an attorney, I'd be presumptuous to announce that I have all of the answers to the legal questions, but from the point of view of an observer of the scene for many years, I can offer some assorted opinions of my own.

Recently I received a letter from a naval officer in Florida mentioning a law known as Sec. 843.16, Title 44 of the State Statutes of Florida, which zonks the use of police monitor receivers except in emergency vehicles or those vehicles belonging to the holder of a ham radio license. Another letter came in from a reader in Kansas City, Missouri asking if I had heard anything about a local scanner owner who had been given a \$25 fine for having a police scanner in his car.

A reader in Omaha wrote to say that he didn't think that Nebraska had any laws against mobile police monitoring, but he did know that some other areas did have such



laws. The reader observed that since states and cities don't have the right to issue radio licenses, they don't have the right to deny the right of anybody to use any type of radio.

Some years ago I received a note from a scanner user who worked at a radio station in Corvallis, Oregon. He enclosed a news service report that the Chief of Police in Eugene, Oregon made the statement that most radio stores sell an inexpensive device that permits criminals to listen in on police calls. In an effort to evade the ears of the criminals, his department had used up four different radio codes and, at that point, was proposing to install a new \$62,700 revision in the police radio system to keep the messages secret.

A reader in Florence, South Carolina wrote to ask if it was true that there is a local ordinance in Florence which prohibits police or fire scanners in cars or even homes. He asks if such a law could be enforced.

Another reader in Michigan wonders about a law which prohibits the installation of scanners in vehicles, asking if a hand-held scanner lying on the vehicle seat is considered to be an "installation" in the vehicle.

Another reader in Oklahoma asks if we can advise him if the old Oklahoma City law to foil mobile police monitoring is still in effect. This had been enacted back in the 1930's when the local police were on 2450 kHz. It forbade any radio receiver to be installed in a vehicle if the receiver was capable of picking up frequencies higher than 1500 kHz. If that law was still valid, he noted, it would affect scanners and also mobile telephones, business radio, CB, ham radio, and even regular AM/FM broadcast receivers. In the 1930's, 1500 kHz was the upper limit of the AM broadcasting band. It wasn't changed to the present 1600 kHz until just prior to WWII.

And so it goes. There has always been an element of confusion and vagueness about the monitoring of police transmissions. Some have suggested that criminals might take portable or mobile scanners along on "jobs" so that they could listen for information on patrols and road blocks. There have actually been instances where criminals have been apprehended and were found with scanners in their possession. Police have found that criminals have also used—as part of their working aids—sneakers, flashlights, crowbars, gloves, screwdrivers, drills, files, tape, rope, cars, and ladies' stockings, yet no one has suggested that any of these items are inherently advantageous to or intended for use by criminals, nor has anyone decided to restrict their use by the general public. The fact is that just about anything from a credit card to chewing gum can be used for an ill purpose by persons wishing to commit a crime; if one were to compile a listing of items normally used by criminals in their line of work, scanners would probably be near the bottom of that listing. Crime, of course, has been around for quite some years now, long before the invention of radio.

The vast majority of scanner owners are

law abiding citizens who simply enjoy listening to the activities of their area law enforcement agencies. And why shouldn't citizens do this? To most people, the job of a police officer is interesting and exciting, having elements of danger and intrigue. To be able to listen to communications relating to these activities is akin to riding along in the front seat of a patrol car, but without the danger. It's better than watching *T. J. Hooker*, *Hill Street Blues*, *CHiPs*, *Adam 12*, *Kojak*, *Dragnet*, and *SWAT* all rolled into one. The public is, after all, supportive of the police and their work, not only on an emotional or philosophical level but in a much more direct way—in the form of the taxes we pay that comprise the salaries for the police personnel and the money to purchase the equipment they require.

While it's true that there are police departments that seek to operate in secret and bristle at the thought that the public is hearing what they say, there are also many police departments that not only don't mind the practice but even encourage monitoring. Some have given out copies of the codes and frequencies to the public. Their theory is that they're doing a good job and they're proud of it; moreover, they'd like the public to know the lengths to which the officers extend themselves to get that job done.

According to a story that appeared in *The*

*An early police radio mobile installation. This one is from 1924 and shows a Scotland Yard vehicle in England. The complex antenna mounting rack could be folded down to permit the vehicle to pass beneath low bridges and trees.*

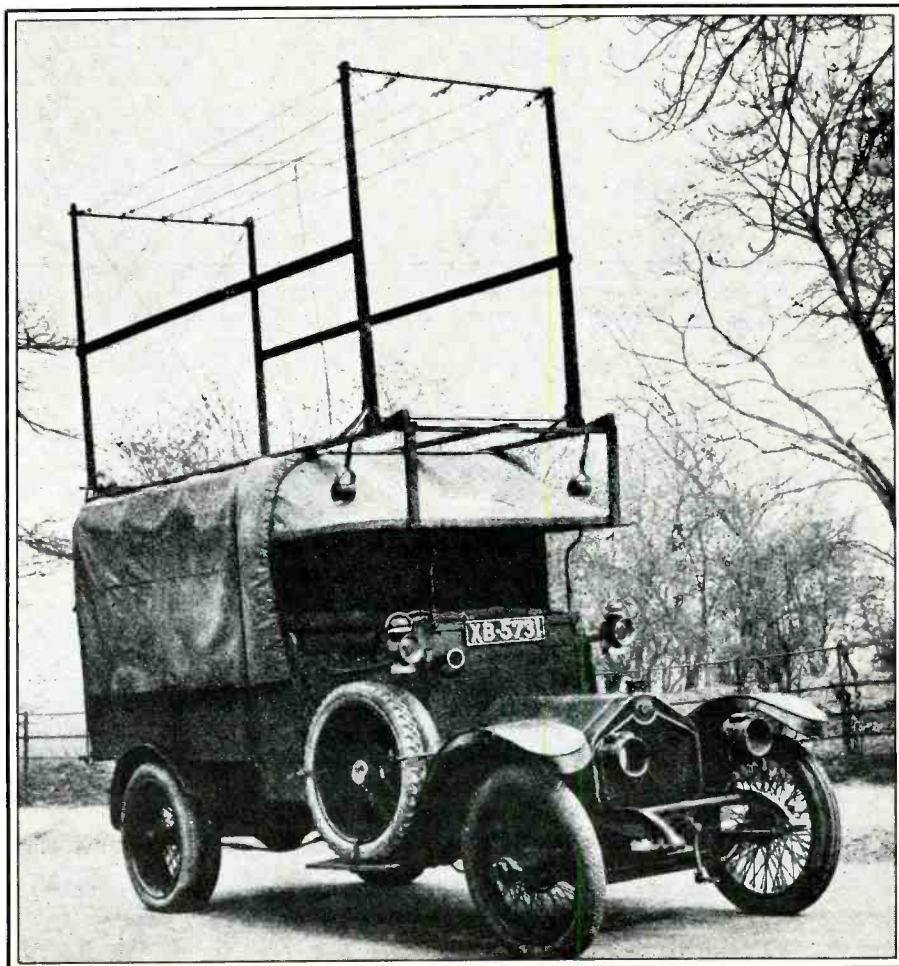

**"POLICER"**  
LOW WAVE ADAPTER  
80 to 200 METERS  
POLICE CALLS  
With the Rahm "POLICER"

Over 25 cities now broadcasting daily POLICE CALLS. Most exciting programs "on the air." Help your local police capture criminals.

The Rahm "POLICER" is manufactured in two models, for the 227 detector tube and for the 224, and performs on any t.r.f. receiver. Specify which model when **ONLY** ordering. Fully guaranteed. Dealers get our quantity prices.

**\$250**  
COMPLETE

**RAHM CORP.**  
1481-A Merchandise Mart, Chicago, Ill.

*In 1931 this little gadget was being offered to the public to permit the monitoring of police calls on any household broadcast receiver. In those days, police stations operated between 1700 and 2600 kHz. It suggested that the public could help the local police "capture criminals." The device was an immediate success. The public just loves to listen to the police in action!*



New York Times on March 26, 1968, "The New York Police do not object to what they call innocent use of police receivers in the home, such as youngsters exploring the airwaves. Indeed, the best protection for a police radio communications system is the monstrous repetition of most of its messages. A police frequency may have to be monitored for hours before a dramatic incident arises and even then the available information may be cryptic."

Almost on the heels of the story in *The New York Times*, the *APCO Bulletin*, official publication of the Associated Public Safety Communications Officers, ran a story (May 1968 issue) in which it was stated, "Unquestionably times and conditions have changed, especially in our large cities, but there are few, if any, cities or states where the bad guys actually outnumber the good guys. All the TV time they are given just makes it look that way. Certainly, few departments at present have all of the cars or personnel needed. Immediately alerting the police radio listeners in the area where the crime is committed could provide a lot more watchful eyes than most budgets allow."

Those departments that have complained about the public monitoring their communications, however, do mention this last factor, although in a negative way. They say that letting the public know the location of major accidents, crimes, disasters, hostage situations, etc., sometimes serves only to attract large crowds of curious onlookers who get in the way and tend to complicate the work of public safety personnel.

We do try to direct scanner owners to the right agency for the answers to their questions, although it isn't always easy to find an agency that will offer a definite answer on the use of a mobile scanner in a specific area. The case of the Oklahoma City law mentioned previously came up in the early 1960's. A local radio station that happened to operate above 1500 kHz dug up the old law and decided to make a test case out of it, more with tongue in cheek than anything

## Public safety communications... is it too public?



**The Motorola Digital Voice Protection System keeps public safety communications private.**

If you want the highest degree of communications security commercially available today choose a Motorola DVP System. We've developed the most complete line of digital voice communications equipment - from portables to microwave.

Using highly sophisticated digital scrambling techniques, you can communicate in a way that's totally unintelligible to unauthorized listeners.

There are no voice like sounds in the scrambled message that can be unscrambled. That's because a Motorola DVP System produces a digital signal that sounds like noise. Yet authorized personnel equipped with a Motorola DVP radio containing the correct code get clear messages with excellent voice recognition.

If you want to know more about the Motorola Digital Voice Protection System, just fill out the coupon below.

**AA MOTOROLA**  
Communications and Electronics, Inc.

*In 1980, this tacky Motorola DVP scrambler ad appeared that depicted a scanner in use by three unsavory looking characters. Feeling that such representations were not in the best interests of scanner users, enthusiasts embarked on a letter writing campaign expressing outrage. Motorola decided to discontinue this ad.*

else. Obviously the ancient and outdated law wasn't being enforced; there were few who knew that it was still on the books.

The station sent a staff member down to the police station to turn himself in, confess his sins, and ask for the court's mercy for unauthorized listening to the broadcaster operating on the frequency above 1500 kHz. In theory, every car in Oklahoma City was

equipped with an illegal radio. The police had no idea what to do with the admitted "sinner." They refused to enforce the law and thereby become a part of the radio station's publicity stunt.

The FCC, when asked about the monitoring of police transmissions, has traditionally taken the position that it is only concerned if the monitoring violates Section 605 of The Communications Act; this primarily relates to persons revealing what they might overhear, or making beneficial use of that information. As for listening that doesn't run afoul of Section 605, the FCC doesn't get involved and isn't concerned. The FCC does not otherwise regulate listening, although the agency is aware that local and state regulations have been established to regulate listening to one extent or another. The FCC has no particular objections to such statutes, nor do they see anything wrong with any persons who might get snagged by such laws to fight them in a court. In other words, it's not their department.

Essentially, there are a lot of questions and only a few real answers. But you can be assured that for the past 60 years the public has been absolutely entranced by listening to these transmissions, and there is little reason to believe that its position as one of the nation's favorite pastimes is in any immediate jeopardy. Enjoy!

PC

# IC-R71A

**The Best Just Got Better**  
**The Superior Grade Communications Receiver . . .**  
**at a price you can afford!**



Special  
\$649.95



**For your discount price on ICOM and other major brands call 812-422-0231, 0252**  
220 N. Fulton • Evansville, IN 47710  
ICOM & WILSON Commercial Equipment Available

MON-FRI 9AM-6PM  
SAT 9AM-3PM

Please send all reader inquiries directly.

# It's Back! THE AMATEUR RADIO VERTICAL ANTENNA HANDBOOK

CAPT. PAUL H. LEE, USN(RET), N6PL

Capt. Paul H. Lee's *Vertical Antenna Handbook* became a classic in its first printing. Out of print for several years, this Second Edition has been brought out in response to your demand and the needs of the service. Among the topics covered are vertical antenna theory, design, installation, and construction. Specific information is given on vertical arrays, feeding and matching, short verticals, ground effects, and multiband and single-band verticals, plus there is a section that answers many of the most commonly asked questions about vertical antennas for the amateur. The Second Edition features an addendum on antenna design for 160 meters, the band that finally is coming into its own.

Order your copy now.



CQ Publishing, Inc.  
76 N. Broadway, Hicksville, NY 11801

Please rush me my copy of the 2nd Edition of *The Vertical Antenna Handbook*:

\$9.95 for the book plus \$2 for shipping & handling.

Name \_\_\_\_\_

Address \_\_\_\_\_

City \_\_\_\_\_

State \_\_\_\_\_

Zip \_\_\_\_\_

Mastercard  VISA



My account number is: \_\_\_\_\_

# LISTEN UP!

Here's what you've been looking for – an all new hard-hitting monthly magazine which gives a unique insider's view of what's really going on in the world of communications. POP' COMM is your primary source of information – bigger and better than any communications magazine, with exciting coverage of scanners, shortwave broadcast & utility stations, spy stations, pirate and clandestine broadcasters, RTTY monitoring, survivalist communications systems, FCC news, wiretapping and bugging, voice scrambling/unscrambling, surveillance/undercover communications, satellite & cable TV, sophisticated telephones, & more. What you've been looking for all along! Take advantage of substantial savings over the newsstand price by subscribing now. Don't miss out on even one single issue of POPULAR COMMUNICATIONS – order your subscription now.

POPULAR COMMUNICATIONS  
SEPTEMBER 1984 \$1.05  
\$2.50 CANADIAN  
War In The Mideast:  
Tune In On It!

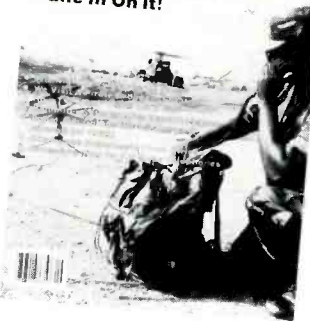

Twelve  
Issues

\$14

# SUBSCRIBE NOW & SAVE!

POPULAR COMMUNICATIONS 76 N. Broadway, Hicksville, NY 11801

Yes! The NEW POPULAR COMMUNICATIONS is just the magazine I've been looking for. Start sending it to me now! I understand that I may cancel at any time for any reason, and receive a full refund on my unused subscription.

Paid by:  Check  Money Order  MasterCard  Visa  
My account number is \_\_\_\_\_

\_\_\_\_\_  
\_\_\_\_\_  
\_\_\_\_\_  
\_\_\_\_\_

Name \_\_\_\_\_

Street \_\_\_\_\_

City \_\_\_\_\_

State \_\_\_\_\_

Zip \_\_\_\_\_

1 Year (12 issues) \$14.00  
Newsstand price \$23.40

2 Years (24 issues) \$25.00  
Newsstand price \$46.80

3 Years (36 issues) \$36.00  
Newsstand price \$70.20

Canada/Mexico — one year \$16.00 two years \$29.00 three years \$42.00 Foreign — one year \$18.00 two years \$32.00 three years \$48.00 Foreign Air Mail — one year \$71.00 two years \$139.00 three years \$207.00



# Selected English Language Broadcasts

Fall 1984

BY GERRY L. DEXTER

**Note:** This list was accurate at the time of compilation. Hundreds of English language broadcasts are to be found on the shortwave bands every day. This is a representative sampling and not intended as a complete reference. Some stations air only part of their broadcasts in English during a given hour. Others will run their English segments into the next hour or for several hours continuously and are not necessarily carried over in this listing. Some major broadcasters such as the BBC, Radio Moscow, The Voice of America and Radio Australia maintain virtual 24-hour English services daily. All times are in GMT.

Time	Station/Country	Frequencies
0000	Radio Sofia, Bulgaria	9.700, 11.870
	RBI, East Germany	9.730, 11.975
	Radio Japan	17.755
	VOPK, Kampuchea	9.695, 11.940
	REE, Spain	9.630, 11.880
	Vatican Radio (0050)	6.015, 9.605, 11.845
	R. Tirana, Albania	7.060, 9.760
	Kol Israel	7.440, 9.815, 11.655
	R. Beijing, China	15.385, 15.520, 17.795
	BRT Belgium (0030)	9.925, 11.620
RCI, Canada	5.960, 9.755	
0100	Austrian Radio (0130)	5.945, 9.770
	Radio Havana Cuba	11.930, 15.300
	HCJB, Ecuador	9.745, 15.155, 15.250
	RBI, E. Germany (0130)	9.730, 11.975
	REE, Spain	9.630, 11.880
	SRI Switzerland (0145)	6.135, 9.725, 9.885, 12.035
	Voice of Greece (0130)	9.420, 9.865, 11.645
	RAI, Italy	9.575, 11.800
	R. Prague, Czechoslovakia	5.930, 7.345, 9.540, 9.740, 11.990
	Deutsche Welle, W. Germany	6.040, 6.085, 6.145, 9.545, 9.565, 9.590, 11.785
0200	Voice of Nicaragua	6.017.5
	Kol Israel	7.440, 9.815, 11.655
	R. Beijing, China	15.385, 15.520, 17.795
	RCI Canada	5.960, 9.755
	VOFC Taiwan	11.825, 15.345
	RAE Argentina	11.710, 11.755, 15.345
	R. Nacional, Brazil	15.290
	R. Havana Cuba	11.930, 15.300
	HCJB, Ecuador	9.745, 15.155, 15.250
	RBI, E. Germany (0230)	9.560, 11.840, 11.975
R. Budapest, Hungary	6.025, 6.110, 9.520, 9.835, 11.910, 12.000	
0300	R. Korea, S. Korea	11.810, 15.575
	R. Netherlands (0230)	6.165, 9.590
	R. Polonia, Poland	6.095, 6.135, 7.145, 7.270, 9.525, 11.815, 15.120
	R. RSA, South Africa	5.980, 6.020, 9.615
	RSI, Sweden (0230)	9.695, 11.705
	R. Cairo, Egypt	9.475, 9.675
	R. Tirana, Albania (0230)	7.120, 9.760
	R. Beijing, China	15.385, 15.520, 17.795
	R. Bucharest, Romania	5.990, 9.510, 9.570, 11.810, 11.830, 11.940

Time	Station/Country	Frequencies	
	R. Kiev, Ukraine	9.800, 11.720, 11.770, 15.100, 15.485, 17.860	
	RCI Canada	5.960, 9.755	
0300	Voice of Greece (0330)	9.420, 9.865, 11.645	
	R. Tirana, Albania (0330)	6.200, 7.300	
	R. Beijing, China	15.385, 15.520, 17.795	
	R. Botswana (0330)	7.255	
	R. Belize	3.285	
	HRVC, Honduras	4.820	
	RCI Canada	5.960, 9.755	
	Voice of Kenya	4.915	
	Radio Tanzania	5.050	
	Austrian Radio (0330)	5.945, 9.770	
0400	Radio Havana Cuba	11.930, 15.300	
	HCJB, Ecuador	9.745, 15.155, 15.250	
	R. Budapest, Hungary (0315)	6.025, 6.110, 9.520, 9.835, 11.910, 12.000	
	Radio Japan	17.755	
	R. Korea, S. Korea (0330)	9.570, 11.820, 15.575	
	Radio Netherlands	6.165, 9.590	
	R. Polonia, Poland	6.095, 6.135, 7.145, 7.270, 9.525, 11.815, 15.120	
	UAE Radio Dubai (0330)	11.730, 15.435, 17.775	
	Radio Cairo, Egypt	9.475, 9.675	
	Voice of Turkey	11.755, 17.815	
0400	Austrian Radio (0430)	5.945, 11.665	
	R. Sofia, Bulgaria	11.750	
	Radio Havana Cuba	11.760, 11.930, 15.300	
	HCJB, Ecuador	9.745, 15.155, 15.250	
	Radio New Zealand	11.960	
	Voice of Nicaragua	6.017.5	
	Radio Bucharest, Romania	5.990, 9.510, 9.570, 11.810, 11.830, 11.940	
	Radio Earth/WRNO	6.185	
	Radio France Intl.	7.135, 9.550, 9.790, 11.735, 11.875	
0500	Radio Bucharest, Romania	11.840, 11.940, 17.790	
	Radio Havana Cuba	11.760	
	HCJB, Ecuador	6.095, 9.745, 15.155, 15.250	
	RBI, E. Germany (0530)	9.560, 11.975	
	Radio Japan	15.300, 17.810	
	Radio New Zealand	11.960	
	Radio Netherlands (0530)	6.165, 9.715	
	REE, Spain	9.630, 11.880	
	Deutsche Welle, W. Germany	5.960, 6.120, 9.545, 9.690, 11.705	
	RDP, Portugal	6.130, 9.740	
0600	BSKSA, Saudi Arabia	11.855	
	Radio Kuwait	15.345	
	Voice of Nigeria	7.255	
	Radio Tanzania	9.745	
	Radio Havana Cuba	11.760	
	HCJB, Ecuador	6.095, 9.745, 15.155, 15.250	
	Radio New Zealand	11.960	
	VOIRI, Iran (0630)	9.022, 15.084	

Time	Station/Country	Frequencies	Time	Station/Country	Frequencies
	R. Cook Islands	11.760		1500 HCJB, Ecuador	15.115
	GBC, Ghana	4.915		R. Japan	9.505
	Radio Kiribati	14.802 (SSB)		Voice of Greece (1535)	9.815, 11.645, 15.635
	TWR Swaziland	9.730		Voice of Indonesia	11.700, 11.770, 11.790, 15.150
	ELWA, Liberia	4.765		RCI Canada	11.955, 17.820
0700	R. Sofia, Bulgaria (0730)	11.720, 15.310		VORE, Ethiopia	9.560
	Radio Havana Cuba	11.760		R. Yugoslavia	9.620, 15.240, 15.300
	Radio Japan	9.505	1600	UAE Radio, Dubai	15.300, 15.320, 21.655
	Radio New Zealand	11.960		Radio Pakistan	9.860, 11.670, 15.445, 15.565, 17.680
	KNLS Alaska	11.850		Voice of Vietnam	10.040, 15.010
	SIBC Solomon Islands	9.545		Radio France	15.155, 15.300, 15.315, 17.720, 17.795
	VOFC Taiwan	5.985, 11.740	1700	RAE Argentina	9.690, 15.345
0800	Radio New Zealand	11.960		Radio Japan	9.505, 11.815
	Radio Malaysia	9.750, 15.295		Kol Israel	9.920, 15.590, 13.720
	TWR Monaco	9.495		BSKSA, Saudi Arabia	11.855
	SIBC Solomon Islands	9.545		Voice of Nigeria	15.120
	CFRX Canada	6.070	1800	Radio Nacional, Brazil	15.280
	KNLS Alaska	11.940		Radio Kuwait	11.675
0900	Radio Japan	9.505		Voice of Nigeria	15.120
	Radio New Zealand	11.960		All India Radio	11.620
	Red Cross, Switzerland (0040 last Sunday of month)	17.795, 21.520, 21.630		4VEH, Haiti	11.835
	Radio Oman	11.890		BSKSA, Saudi Arabia	11.855
	KTWR Guam	11.840		BRT Belgium	15.560
	FEBC Philippines	11.890	1900	R. Sofia, Bulgaria (1930)	9.700, 11.720
1000	Radio New Zealand	11.960		R. Jamahiriyyah, Libya	15.450
	BSKSA Saudi Arabia	11.855		VOIRI Iran (1930)	9.022, 11.930
	Radio Oman	11.890		R. Afghanistan	9.655, 11.960, 15.077
	SLBC Sri Lanka	11.835, 15.120		Radio Kuwait	11.675
	R. Beijing, China	9.860, 11.660		Kol Israel	11.675, 12.025, 13.745, 15.585, 17.685
1100	Radio Japan	9.505		HCJB, Ecuador	17.790, 21.480
	Radio New Zealand	11.960	2000	Radio Baghdad, Iraq (2030)	9.610, 11.700, 11.790, 13.700, 17.720
	Radio Finland	15.400, 17.800		Radio Algeria	9.640, 9.685, 15.215, 17.745 (all variable)
	Radio Beijing, China	15.520		Radio Kuwait	11.675
	Pyongyang, N. Korea	9.745, 9.977		VOIRI Iran	11.930
	NBC Papua New Guinea	4.890		R. Yugoslavia	9.620
	Voice of Vietnam	9.840, 12.035		Radio Mediterranean, Malta	9.510
	RTM Malaysia	9.565	2100	R. Sofia, Bulgaria (2130)	9.700, 11.750, 11.850
1200	Austrian Radio (1230)	15.320		Radio Yugoslavia (2115)	9.620
	RCI Canada	9.650, 11.855, 11.955, 15.440, 17.820		VOFC, Taiwan	11.825, 15.345, 17.800
	HCJB Ecuador (1215)	11.740, 15.115, 17.890		Kol Israel	9.815, 11.655, 12.025, 13.745, 15.585, 17.685
	VOPK Kampuchea	9.695, 11.940		HCJB, Ecuador	15.295, 17.790, 21.480
	R. Tashkent, Uzbek	7.340, 9.650, 9.715, 17.785, 15.460		R. Jamahiriyyah, Libya	11.815
	Radio Finland	15.400, 17.800	2200	R. Sofia, Bulgaria (2230)	9.700, 11.870
	Voice of Greece (1235)	9.815, 11.645, 15.635		R. Jamahiriyyah, Libya	11.815
	R. Tirana, Albania (1230)	11.960		R. Vilnius, Lithuania	11.720, 11.960, 15.100, 15.485, 17.860
	Ulan Bator, Mongolia	9.615, 12.015		RCI Canada	9.755
	R. Beijing, China	11.650, 15.520		Voice of Turkey	11.870
	R. Bangladesh (0030)	17.800, 21.670		Radio Japan	9.645, 15.235, 17.755
1300	HCJB, Ecuador	11.740, 15.115, 17.890		Radio Yugoslavia	9.620
	Radio Japan	9.505	2300	RBI, E. Germany (2315)	9.730, 11.975
	SLBC Sri Lanka	15.425		Radio Japan	17.755
	Radio Finland	15.400, 21.475, 25.950		RSI, Sweden	11.710, 15.270
	Ulan Bator, Mongolia	9.575, 15.305		Kol Israel	7.440, 9.815, 11.655
	Voice of Vietnam (1330)	10.040, 15.010		R. Kiev, Ukraine (2330)	9.800, 15.100, 15.485, 17.860
	KTWR, Guam	9.510		Pyongyang, N. Korea	9.745, 15.230
	Radio Singapore	11.940		R. Sofia, Bulgaria	9.700, 11.720
	All India Radio	11.810, 15.335			
1400	HCJB, Ecuador	11.740, 15.115, 17.890			
	R. Korea, S. Korea	9.570, 9.750, 15.575			
	RSI Sweden	15.190			
	R. Tashkent, Uzbek	7.340, 9.650, 9.715, 11.785, 15.460			
	Radio Finland	15.400, 17.800			
	All India Radio	11.810, 15.130, 15.335, 17.705, 17.875			
	BRT Belgium	17.610, 21.815			
	Voice of Nigeria	15.120			





Two UN announcers broadcasting to Europe, the Middle East, and North Africa. (Photo: United Nations/Milton Grant)

# United Nations Radio

BY GERRY L. DEXTER

**F**rom live coverage of General Assembly sessions to phoned “beeper” reports to your local broadcaster, United Nations Radio covers the world’s activities inside and out.

In a sense, UN Radio got its start at the very first General Assembly meeting in 1946 in London. The British Broadcasting Corporation provided facilities for the small UN Radio production team as well as for correspondents from a number of world broadcasters who wished to provide “back home” coverage of that first official General Assembly session.

The next step took place during the first General Assembly’s Second Session held at Lake Success, New York in October of 1946. By this time, the UN was providing studio facilities for the world’s news corres-

pondents so that reports of UN activities could be transmitted back to the nations and broadcast stations wanting coverage of the session. These first meetings were also aired in English and French, with special programming also recorded by UN Radio personnel in the additional languages of Spanish, Russian, and Chinese.

The Canadian Broadcasting Corporation as well as the U.S. Department of State (which at that time was responsible for the Voice of America transmitters) provided facilities for these early broadcasts. So did stations such as WRUL (now WYFR) in the early days of UN Radio.

The UN Radio staff numbered as many as 53 individuals from some 18 countries during the early years of the radio division. To-

day that number is 83, including 23 on “special services” who may appear in the studios to do just one program per week.

The UN Radio Division is actually called the Radio and Visual Services Division and it, in turn, is part of the Department of Public Information.

UN Radio spends a great deal of its time maintaining contact with existing broadcasting stations, suggesting themes and story ideas for features and programs about the UN, in addition to providing scripts and recordings to any station wishing to use such materials.

Essentially UN Radio is charged with two basic tasks: first, to provide facilities and assistance for newsmen accredited to the UN. Many of these are permanently based at



Studio 8 at the UN, on the air. (Photo: United Nations)

A master control room has audio lines feeding in from the UN studios, from the General Assembly, the Security Council, Trusteeship Council, and various conference rooms. Lines go out from Master Control to Voice of America facilities as well as to radio and television networks.

When it is in session, UN Radio provides gavel-to-gavel coverage of General Assembly meetings. Normally this takes place between 1530 and 0000 GMT on a wide and variable list of frequencies. Most of these broadcasts are beamed out from the Voice of America's transmitters at Greenville.

Other than the General Assembly, the mainstay of UN broadcasting is news of UN activities, although such programs often don't go out under a title that would indicate an obvious news content.

There are also some interesting English language programs, including a broadcast to the Caribbean on Fridays at 2100 GMT, "UN Africa" on Saturdays at 0215 and 0545, "UN Calling Asia" on Saturdays at 1015, and "The Week at the UN" on Fridays at 1930.

The UN's radio programming is not totally neutral in its approach however. The United Nations, having condemned the apartheid policies of South Africa, puts radio to work to combat the practice. There is an "Anti-Apartheid Program" (and called just that) produced by the Anti-Apartheid Programs Section which is sent out on tape in six Southern African languages (including English) to broadcasters in Africa to air at their choice of times. Oddly, it is not a part of the UN's shortwave efforts.

The United Nations ruling on the question of Namibia (Southwest Africa), currently administered by the Republic of South Africa, has also resulted in the production of an annual series of six programs on the Namibia question.

Women receive special treatment by UN Radio, too. A program in English dealing with the problems of women in the Third World countries is on Fridays at 1945.

Listeners' questions about the United Nations are answered in the "UN Radio Club," which is aired on shortwave once a month.

A number of shortwave stations carry UN programs as part of their regular schedules, although staffers at the UN Radio Division in New York seem to have no idea as to which carry UN features, or when, or even how many stations are involved. One that does is RAI in Rome, with a ten minute UN news summary in Arabic on Mondays at 1920.

The United Nations also maintains a very limited broadcasting operation in Switzerland. Again, this station doesn't have its own transmitter, it rents one at Prangins from the Swiss Post Telephone Telegraph authority. The station, with call letters HBX, carries a ten minute news program in Russian Monday through Friday at 1830 on 14.500 MHz, upper sideband. The program is beamed toward Moscow. Although beamed away from the United States, it has been heard on numerous occasions here.

The UN also has its own amateur radio



Audrey Hepburn is just one of many stars who have been heard on UN programming over the years. (Photo: United Nations)

know more about. UN programming is thus broadcast over stations in 167 nations, trust territories and islands, not all of them members of the United Nations.

The radio news desk of UN Radio produces daily written coverage of events for use by its own regional centers and is available to correspondents for their use or adaptation as well.

In a sense, UN Radio is like that popular soft drink—it's an "un-station" in that it doesn't have any transmitters of its own. Nearly all of the programming from the United Nations broadcast on a "realtime" basis is aired over Voice of America facilities at Greenville, Tangier, Monrovia, and the Philippines. Broadcast time is rented from the Voice of America at a cut-rate price of \$24 per hour (3,051 transmitter hours were used in 1983).

Shortwave from the United Nations is aired in English, Afrikaans, Arabic, Chinese, French, Greek, Hebrew, Indonesian, Japanese, Filipino, Portuguese, Russian, Somali, Sotho, Spanish, Swahili, Thai, Tswana, Turkish, Urdu, Xhosa, and Zulu.

Presently, there are four broadcast programming divisions: The European and Middle East Service, Latin American Service, Trans-Pacific Service, and English Language Service.

UN Radio has eight fully-equipped and staffed studios in the first basement of the General Assembly building in New York. In addition to UN Radio personnel, other broadcast correspondents may use the studios when they're not in use for UN programming.

The UN also makes its library and archives available to correspondents. It contains thousands of tapes of UN meetings, UN agencies and field missions, recordings of special UN concerts and representative music from around the world. Recordings of some news conferences and other special events date back to the days of the League of Nations.

the United Nations (about 400 at present). During the General Assembly Sessions from mid-September to mid-December, another 600 correspondents arrive at UN Headquarters and have to be accommodated. Some 45 countries maintain regular UN correspondents. Another 200 correspondents are accredited to the UN in Geneva, Switzerland, which has eight broadcast studios available.

To supplement the work of individual news people covering United Nations activities, the UN also prepares various programs for broadcast at private and government stations around the world. Often these are produced after consultation with broadcasting executives and programmers so that the UN has a better idea of the areas people want to



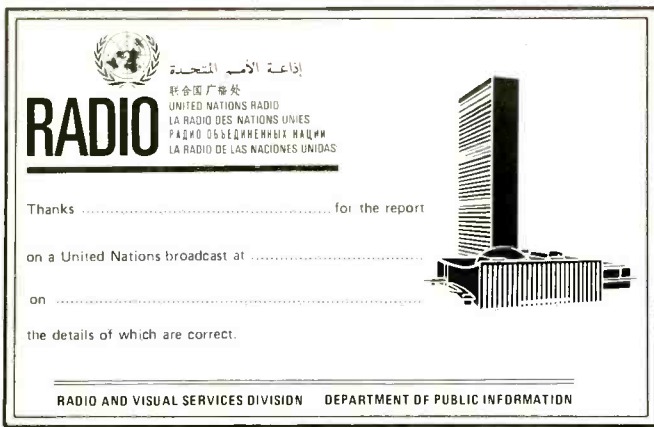

The United Nations Radio's QSL card.

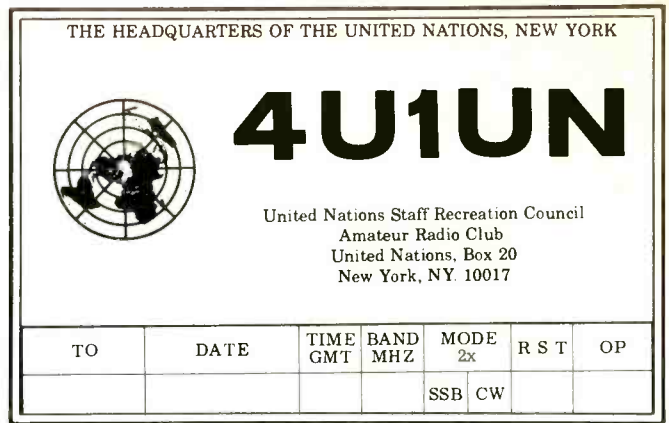

4U1UN, the UN ham station, sends this QSL card for contacts with amateur operators around the world.

station, using the call letters 4U1UN. It's located on the 40th floor of the UN building.

As might be surmised, the United Nations is not entirely happy with the limitations under which it must operate its radio facility. Programming from United Nations Radio is, as you may have guessed, limited pretty much to the weekends, with the exception of coverage of the General Assembly. These limitations caused a special UN Committee on Information to be formed, and since 1980, it has been studying possible alternatives for UN broadcasting.

One such alternative involves the UN setting up its own worldwide shortwave "network" which would feature regionalized segments for Africa, Asia and the Pacific, Latin America, and Western Asia/North Africa. Transmissions for each region would take place from the headquarters of the UN regional commission concerned.

In its study, the committee noted that the growth of shortwave broadcasting and increase in listenership in recent years is some evidence of the cost-effectiveness of such a

network. Broadcasts, if the UN were to go with this system, would be on a daily basis, with no less than 30 minutes of program time for each language used.

Under the proposed plan, 250 kilowatt regional transmitters would be stationed near Addis Ababa, Ethiopia; Bangkok, Thailand; Santiago, Chile; and Baghdad, Iraq. Rough estimates envisage an overall operating cost of some \$13.5 million per year, with construction costs for such a facility seen at around \$18 million.

The network would operate some 45 hours per week to various areas. UN headquarters in New York would produce mostly news programs, relayed via satellite to the four regional transmitters. Other programming would come from the regional sites.

Some UN delegations are very much in favor of this idea. Others are very much against it, due mainly to the vast amounts of money involved.

Questions have been raised about the effectiveness of the use of taped programming by the UN for airing by other stations. The

feeling is that the UN has no control over the scheduling of such programs and that the time-lag involved is also a severe restriction.

The UN studies recognize that news is the primary reason most people tune in a short-wave broadcast station and that any such new UN Radio Network would have to expand from today's concentration on UN news to one of general news on a worldwide basis. Severe problems are foreseen in achieving impartiality under such an arrangement since most news stories have political overtones which are seen in different lights in countries around the world.

Another possibility being studied at the present time is concentrating the staff for the network in New York and doing all the programming from headquarters, with programs fed to the relay sites.

As an interim measure, the UN is studying the possibility of renting more time from more stations. There are problems here too, in being allotted only "left over" transmitter time, being unable to conclude time rental agreements with broadcasters in strategic areas, or having to deal with program content restrictions which might be imposed by some broadcasters.

So, the jury is still out on which direction future UN Radio operations will take or even whether any great changes will take place at all. It can be safely assumed that any final answer is a considerable distance away.

For the present, shortwave listeners have weekend UN radio programming they can check out. The schedule changes frequently but can be obtained by writing to the Radio and Visual Services Division, United Nations, Room 805, New York, NY 10017.

UN Radio will gladly confirm correct reception reports with a QSL card. Reception reports should be sent to the same address.

Despite the broadcasting limitations under which it now operates, UN Radio on shortwave allows those interested in the United Nations and its activities to keep better informed on UN news—a benefit considering how little attention the UN receives from the U.S. media.

The future may hold an expansion of United Nations broadcasting in one form or another. We'll just have to wait and see what happens. And when. And if. **PC**

UN Master Control where incoming and outgoing transmissions are processed. (Photo: United Nations)

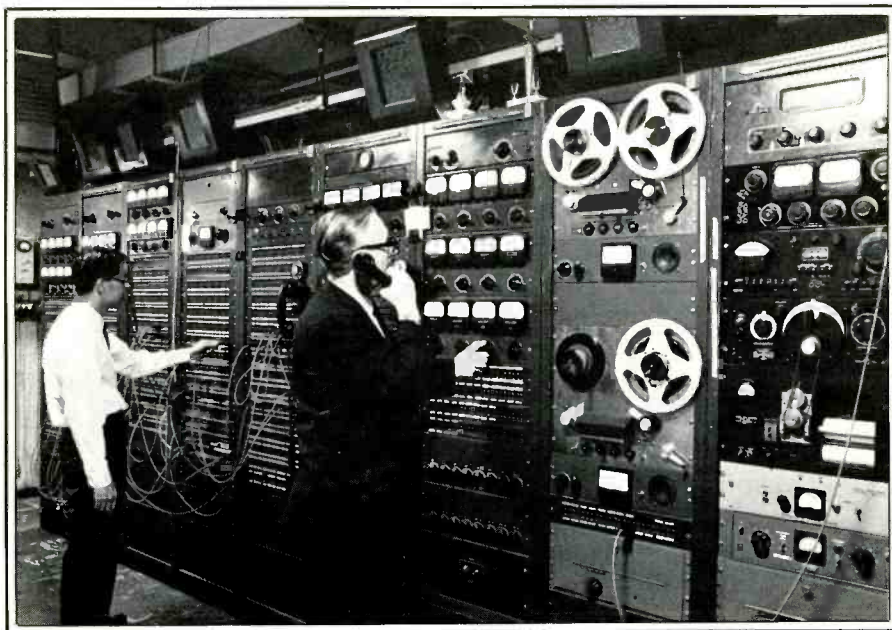

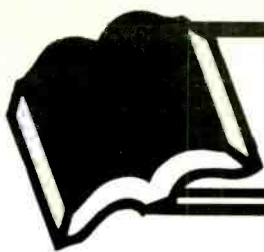

# BOOKS YOU'LL LIKE!

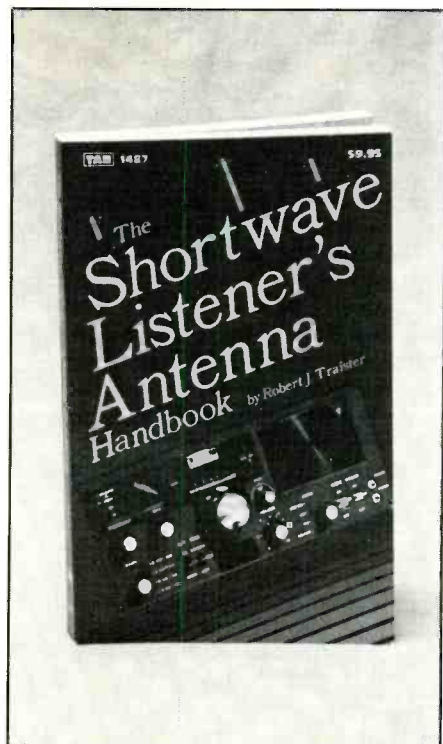

*The Shortwave Listener's Antenna Handbook*, by Robert J. Traister, is an invaluable guide for every SWL and DX enthusiast who wants maximum signal reception. It's a complete guide to understanding (even designing), building, and installing all kinds of receiving antennas for shortwave broadcast and/or utility station reception. One of the nicer things about this book is that it was written to fill the information gap which has traditionally caused DX listeners to adapt and modify ham band antennas for non-ham frequencies. The antennas in this book were designed specifically for maximum performance on shortwave broadcast and utility frequencies.

Traister's book explains how the antenna system is very far from being the least important component of your receiving installation and how even the most sophisticated receiver will deliver only mediocre performance when hooked to an inadequate antenna. Moreover, he shows that even a relatively inexpensive receiver can drag in some very impressive signals when mated to the "right" antenna.

The 191-page book discusses materials, construction practices, and vertical/horizontal/directive antennas. With this information, you'll be able to tackle indoor or

(hidden) limited space secret antennas, improvised antennas made from TV cable, and all sorts of antennas ranging from humble to humongous. There are full illustrations, explanations, diagrams, and step-by-step building instructions for the antennas, as well as accessories such as tuners and couplers. A special section covers various types of radio interference and how to kill it—or at least reduce it considerably.

All of this bountiful harvest of information was written by a very active DX listener for use by other listeners, making it all a very rare treat indeed. *The Shortwave Listener's Antenna Handbook* is available for \$9.95 (plus \$1 postage/handling to addresses in USA/Canada/APO/FPO). The book can be ordered from CRB Research, P.O. Box 56, Commack, NY 11725. With the holiday season upon us, here's the perfect gift you can either give yourself or some other lucky DX enthusiast. And ask CRB for a copy of their new catalog.

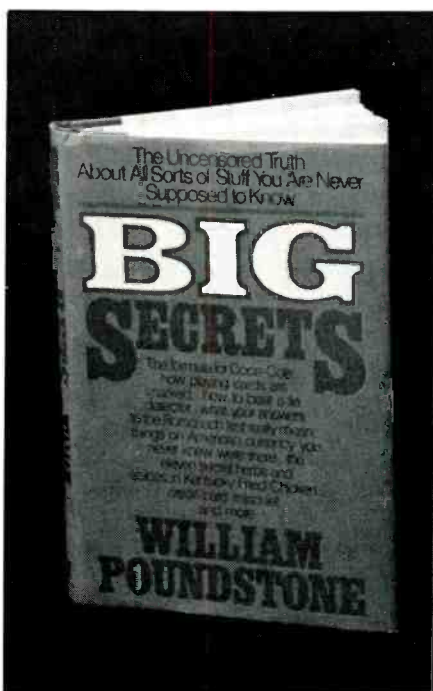

For lovers of that which is hidden, we came across a book which (if you haven't yet seen it) will be a pleasant surprise. This is a 228-page hardcover book titled *Big Secrets* by William Poundstone. The author roams around looking into all sorts of "forbidden" information and offers answers and opinions. He discusses the secret formula for

Coca-Cola, the claimed "11 herbs and spices" in Kentucky Fried Chicken, famous magic tricks, secrets of the Freemasons, and how to pass an eye-chart exam even if you've got 20/400 vision. This is all fine and dandy and written in a fascinating and entertaining style that is most enjoyable to read. The parts of the book that we thought were especially interesting included those in which the author tells, for instance, how to secretly read other people's mail, how to pass a polygraph (lie detector) test (even if you're lying), and he's even got a complete chapter on secret radio frequencies! He discusses the information in the magnetic strip on some credit cards, as well as the "backwards words" on rock music recordings.

The chapter on secret radio frequencies is, essentially, information he says he gleaned from several popular books, some of which you may already be aware—including Gilfer's *Confidential Frequency List*, Kneitel's *Top Secret Registry*, and others. However, Poundstone gives some of his own thoughts on numbers stations, single letter beacons, room "bugs," etc., and he offers plenty of frequencies, too.

It's a pretty good book, and if you're one of those folks who likes to know that you've got as complete a reference library as possible on secret radio frequencies, you'll probably want to have this on your shelf. The book is \$12.95 and is published by William Morrow and Company, 105 Madison Ave., New York, NY 10016. This book is probably available from your local bookstore, or they can order it for you.

Three new catalogs have also recently been issued and you'll want to see these, too.

One of the catalogs is from Universal Electronics, 1505 Ventura Blvd. #1653, Sherman Oaks, CA 91403. This interesting catalog covers things like laser pistols, invisible pain field generators, bugs and bug detectors, ultra-sonic security systems, microtransmitters, secret recording devices, bug jammers, parabolic microphones, voice scramblers, and all sorts of other outrageous things. Really a unique and mind-blowing catalog, to say the very least! It's free.

Universal Shortwave Radio, 1280 Aida Drive, Reynoldsburg, OH 43068, sent us their new catalog containing receivers, portables, antennas, accessories, RTTY gear, and other goodies for shortwave enthusiasts. Be sure to get your copy.

Also ask Spectronics Inc., Oak Park, IL 60304-1890, for their latest SWL catalog. It's quite a find!

PC





Low-power industrial and business frequencies are usually populated by hand-held type transceivers, often intended for communications within factories or warehouses. Monitoring these frequencies offers a genuine challenge.

The author, who writes under the pen name "Alice Brannigan," checks out some mobile communications traffic. Besides monitoring the HF and VHF bands, she's interested in cryptography. Alice lives on a farm near Boston, MA and says she's happy to see so many YLs active in monitoring these days.



# 175 Great Scanner Frequencies!

***If You Haven't Tried These, Now's The Time To Start***

BY ALICE BRANNIGAN

**I**n the July *POP'COMM* I prepared a directory of well over 100 of the more interesting frequencies that can be tuned by owners of communications receivers. When that list appeared in *POP'COMM*, there was a rather quick reaction from scanner users asking for a similar listing for those whose interests lie above 30 MHz. Here 'tis.

These are my personal choices for a well-rounded assortment of frequencies to help you open up new doors that you may not have previously realized were available—just the thing when the frequencies you normally monitor are a bit too quiet for comfort. Naturally, these aren't all of the worthwhile scanner frequencies, just a careful selection of those that are used nationally and have proven to be a good source of unusual listening material, at least at various times.

Frequencies listed below 50 MHz are capable of bringing you some great DX during daylight hours when the ionosphere is in a good mood. I've listed a lot of low-power business and industrial frequencies as these

are great DX challenges and are used by wireless microphone systems in addition to hand-held transceivers.

Not all of the 162 MHz weather frequencies have yet been put into service, but even if you have a local weather station on one of these frequencies you might be able to drag in some distant stations on other frequencies. Frequency 121.5 MHz is not especially active, but I like to keep it programmed into my scanner for those times it does activate. The several communications it has produced have been really exciting.

Radio paging frequencies, which I've listed, do not use voice exclusively and you're liable to monitor all sorts of coded tones as well as voice paging messages. Sometimes the messages you'll hear (the ones in voice, that is) are pretty far out, if not downright cryptic.

Cordless telephones, of course, are beyond fascinating. If you haven't ever checked out these frequencies, now is as good a time as any to start. The 46 MHz fre-

quencies listed here are all newly assigned channels and are used by the latest cordless telephones. For kicks, I've listed 40.68 MHz—no voice transmissions at all here, but all manner of eerie sounds made by radio control and other circuits.

Frequencies stretched out between 162 and 174 MHz, as well as 406 to 420 MHz, are the domain of federal agency stations. There are also several areas between 30 and 50 MHz which (in the United States) are used exclusively by government stations. These frequencies are brimming over with terrific activity, so much that I have not even attempted to list anything here more than a couple of the more widely reported national frequencies. The *Top Secret Registry of U.S. Government Radio Stations* does a fine job of examining the goings-on within the federal bands. For a glimpse of some of the activity in these bands, put your scanner into the search mode and try going through these frequency bands in 500 kHz-wide swatches.

## Scanner Log

30.565 MHz	Developmental stations	123.3	Aero commercial	155.355	Ambulance/hospital
30.84	Low power industrial (2 w.)	123.45	Pilot chit-chat	155.37	Police intersystem
31.995	Developmental stations	123.5	Aero commercial	155.385	Ambulance/hospital
33.005	Developmental stations	140.10	Navy fire/crash units	155.40	Ambulance/hospital
33.12	Low power industrial (2 w.)	140.575	Navy security units	155.475	Police emergency
33.14	Low power business (1/2-w.)	140.82	Navy security units	156.225	Oil spill use
33.40	Low power business (20 w.)	142.35	FEMA	156.80	Maritime calling/emergency
33.995	Developmental stations	142.425	FEMA	157.05	Coast Guard
34.81	U.S. Fish & Wildlife Service	142.975	FEMA	157.075	Coast Guard
34.83	U.S. Fish & Wildlife Service	143.00	FEMA	157.10	Coast Guard
35.02	Low power business & handi-capped paging	148.15	Civil Air Patrol	157.125	Army Engineers
35.005	Developmental stations	149.925	Civil Air Patrol	157.15	Coast Guard
35.64	Radio paging (med. & emergency)	150.435	Army security units	157.175	Coast Guard Auxiliary
35.68	Radio paging (med. & emergency)	150.555	Army security units	157.45	Radio paging (medical)
35.995	Developmental stations	150.98	Oil spill use	157.54	Radio paging (medical)
37.005	Developmental stations	152.005	Medical paging	157.74	Radio paging (business/industrial)
37.60	Utility system intercommunication	152.03	Mobile phone	158.445	Oil spill use (mobiles)
37.84	Utility system intercommunication	152.06	Mobile phone	158.46	Radio paging (business/industrial)
37.995	Developmental stations	152.09	Mobile phone	159.48	Oil spill use
39.005	Developmental stations	152.12	Mobile phone	162.40	Weather
39.06	Public safety low power	152.18	Mobile phone	162.425	Weather
39.48	Police intersystem	152.21	Mobile phone	162.475	Weather
39.80	Army bombing ranges	152.24	Radio paging	162.525	Weather
39.995	Developmental stations	152.48	Radio paging	162.55	Weather
40.07	National parks (transportation)	152.51	Mobile phone	163.25	Radio paging (medical)
40.17	Air Force investigators	152.54	Mobile phone	163.31	Army Engineers
40.19	Air Force investigators	152.57	Mobile phone	163.40	Coast Guard helicopters
40.21	National Parks (transportation)	152.60	Mobile phone	163.41	Coast Guard Intelligence
40.50	Army search/rescue	152.63	Mobile phone	167.05	Federal Communications Commission
40.68	Industrial/Scientific devices	152.66	Mobile phone	170.875	Federal prisons
40.71	Oil spill use	152.63	Mobile phone	173.585	Air Force fire/crash units
41.06	Federal Communications Commission	152.66	Mobile phone	417.20	General Services Administration
42.005	Developmental stations	152.69	Mobile phone	454.00	Oil Spill use
42.98	Low power business (2 w.)	152.72	Mobile phone	458.00	Oil Spill use
43.22	Radio paging	152.75	Mobile phone	460.525	Medical dispatch
43.58	Radio paging	152.78	Mobile phone	460.55	Medical dispatch
43.64	Radio paging (handicapped)	152.81	Mobile phone	460.90	Central Alarm System companies
43.68	Radio paging (handicapped)	152.84	Radio paging	460.925	Central Alarm System companies
45.86	Police intersystem	153.83	Fire hand-helds	460.95	Central Alarm System companies
45.88	Fire mutual aid	154.225	Fire mutual aid	460.975	Central Alarm System companies
46.30	Low power fire (10 w.)	154.28	Fire mutual aid	461.00	Central Alarm System companies
46.61	Cordless telephones	154.295	Fire mutual aid	462.75	Radio paging (business)
46.63	Cordless telephones	154.57	Low power business/industrial (2 w.)	462.775	Radio paging (business)
46.67	Cordless telephones	154.585	Oil spill use	462.80	Radio paging (business)
46.71	Cordless telephones	154.60	Low power business/industrial (2 w.)	462.825	Radio paging (business)
46.73	Cordless telephones	154.625	Radio paging (business)	462.85	Radio paging (business)
46.77	Cordless telephones	155.16	Search/Rescue	462.875	Radio paging (business)
46.83	Cordless telephones	155.16	Search/Rescue	462.90	Radio paging (business)
46.87	Cordless telephones	155.325	Ambulance/hospital	462.925	Radio paging (business)
46.93	Cordless telephones	155.34	Ambulance/hospital	465.00	Radio paging (business)
46.97	Cordless telephones				
47.42	Red Cross				
47.46	Red Cross				
47.50	Red Cross				
49.67	Cordless 'phone handsets/ Hands-free FM sets				
49.70	Army explosives disposal				
49.77	same as 49.67				
49.80	Army explosives disposal				
49.83	same as 49.67				
49.845	same as 49.67				
49.86	same as 49.67				
49.875	same as 49.67				
49.89	same as 49.67				
49.93	same as 49.67				
49.97	same as 49.67				
49.99	same as 49.67				
121.5	Aero emergency				
122.0	Aero weather				
122.2	Aero enroute				
122.6	Aero advisory				
122.8	Unicom				
122.85	Multicom				
122.9	Multicom				
122.925	Multicom				
123.05	Helicopters				
123.1	Search/Rescue				

PC

### EVERYTHING FOR THE LISTENER!

- \* Shortwave Receivers
- \* Scanners
- \* Filters
- \* Tuners
- \* Converters



# GROVE ENTERPRISES

- \* Antennas
- \* Coax
- \* Publications

SEND FOR YOUR FREE CATALOG TODAY!

P.O. Box 98, Brasstown, NC 28902

704-837-9200



# BROADCAST TOPIX

BY MARK J. MANUCY, W3GMG

## DX, NEWS AND VIEWS OF AM AND FM BROADCASTING

**S**ince this is the first month for reader response for this new column, let's dip into the mailbag first thing. Joe Glynn of Baton Rouge, Louisiana, requests when sending reports in that signal strength be included or use the SINPO code. He says this way small market stations reading the column might get some idea of their coverage. A reminder that we encourage reports of other than routine reception. Routine reception would be a station you can hear almost every time you listen for it. If you would like to report all of your DX reception, Harold Frodge tells me the American Shortwave Listeners Club is anxious for the reports. You can reach Harold at 5525 Whitehall, Midland, MI 48640. With all of the other information presented in Broadcast Topix, there isn't sufficient room for routine DX reports.

Two readers, Alan Henney of Takoma Park, Maryland, and John Metcalf of Waukegan, Illinois, have enjoyed the monitoring of broadcast RPUs (remote pickup units). Alan is a traffic bug, listening to the multitude of traffic reports broadcast around the Washington, DC area, while John heard KSL's 26.19 MHz unit from Salt Lake City during a test.

Broadcasters use many frequencies other than the one on which the general public hears them. These auxiliary frequencies have different purposes, and not all stations use all of the frequencies for the same reasons. Probably the most popular uses are for traffic reports and on the spot news reporting. The following frequencies are available: 1606, 1622, and 1646 kHz.

In the HF range, good for long range DX, listen on these frequencies (in MHz): 25.87, 25.91, 25.95, 25.99, 26.03, 26.07, 26.09, 26.11, 26.13, 26.15, 26.17, 26.19, 26.21, 26.23, 26.25, 26.27, 26.29, 26.31, 26.33, 26.35, 26.37, 26.39, 26.41, 26.43, 26.45, and 26.47.

In the VHF range, listen on: 152.87, 152.93, 152.99, 153.05, 153.11, 153.17, 153.23, 153.29, 153.35, 161.64, 161.67, 161.70, 161.73, 161.76, 166.25, and 170.15. In the UHF band there are 56 channels spread between 450.01 to 450.99 and 455.01 to 455.925 MHz. The 25-26 MHz frequencies can be AM or FM modulation but will be almost 100 percent FM. The 161-170 MHz frequencies are exclusively broadcast RPU channels. The 152-153 MHz frequencies are shared with other services and are not as popular as the 161 MHz channels. The 450 MHz frequencies have many repeaters, which will make hearing both sides of the conversation easier if you are tuned to the right frequency. If you don't hear both sides but think maybe you should, shift your scanner either 5 MHz up or down depending on the band you are listening on.



WQAM, Miami. Four legged monster tower in Biscayne Bay (1957).



WMMB, Melbourne, Florida (1963).

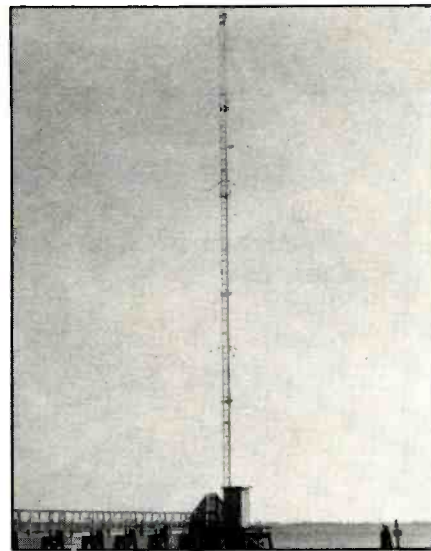

WIRA, Ft. Pierce, Florida (1963).

WIRA, WMMB, WQAM, and WFOY (July) all use towers over water for improved coverage.

As shown by John's QSL from KSL, the 25-26 MHz frequencies can allow long distance DX of RPUs. To give a listing of each station's RPU frequency is beyond the scope of our column. There are books published that list the frequencies used by individual stations by regions. This is probably your best source for specific stations.

There is one other group of frequencies used by radio broadcasters. These are used for studio-transmitter links (STL) instead of the use of leased telephone lines. These links carry programming and metering circuits. The FCC has ten channels from 947 to 952 MHz for STLs. These frequencies require very directional antennas, usually dishes, and probably will not be heard unless you are close to the path of the antennas. There are so many ways of operating these STLs, so no two situations are apt to be the same. For example, just because a station is stereo doesn't mean they will have two STLs. With today's technology, it is easy to use a single STL for two audio channels plus remote control, etc.

I received a number of favorable comments on the July issue's conductivity map of the U.S. I spoke of the BCL uses of the map but the broadcast (AM) engineers use this map to determine the coverage of the station. If the conductivity changes near the station location, the engineer will make measurements with a field intensity meter (FI meter), which is calibrated (in millivolts per meter) as a sophisticated "S" meter costing in excess of \$1200. With the FI meter, the engineer can determine the best location for the station's antenna to give the best coverage. Having the antenna in high conductivity pays off in extra coverage for less power. This summer, while in Louisiana, two Tampa Bay (Florida) stations were heard around the Gulf Coast—WFLA (970), but especially WSUN (620). I seem to hear WSUN day and night no matter where I go around the eastern seaboard. They are located on the western edge of Tampa Bay, with their towers located on either side of the causeway (US 92). The highway goes between the towers! They are huge, four-legged self-supporting towers with the power cabling going under the highway.

WQAM in Miami has a similar huge self-supporting tower sitting out in Biscayne Bay to take advantage of the sea water conductivity. The towers of many New York City stations are located in the swamps of northeastern New Jersey across the river from the "Big Apple." The swamps may not be the best, but it certainly exceeds the poor conductivity of Long Island (.5), and the real estate is probably cheaper by many dollars!

As to the questions of conductivity in other parts of the world, I'm sure some



KOH-710

# KSL RADIO 1160 IS THE WASATCH FRONT (AND MORE)

KSL AM 1160 Salt Lake City, Utah  
1160 KHZ—Clear Channel. 50,000 Watts  
Transmitters: Western Electric 407 A  
CCA 50.000D  
Antenna Current 22 14 Amps  
192° Electrical. 455 foot Vertical  
Antenna, Series Feed.  
Non-directional

Date 25 FEB, 1984

Program VARIOUS

Comments CONFIRMING

RECEPTION OF KOH-710 IFB

TRANSMITTER ON 26.19 MHZ.

Chief Engineer

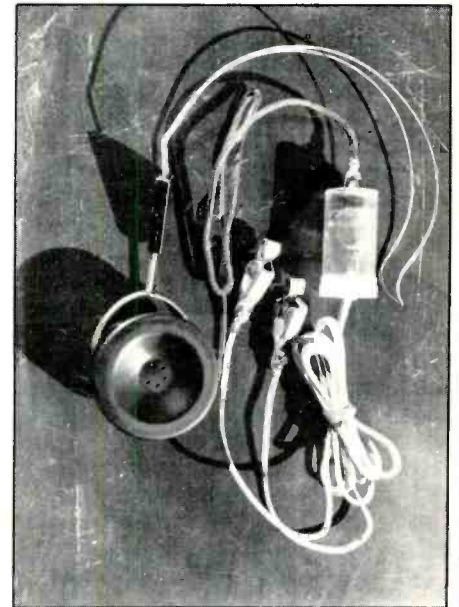

A crystal set from the 1950's.

figures are available to some extent, although they are not as complete as those for the U.S. If I get some additional maps, we'll try to print them. Generally speaking, the better the soil the better it will conduct radio signals. Sand and rock are poor conductors.

In Louisiana, where I was vacationing in June, the conductivity was 15. The main thing I learned was, in addition to the radio signals being stronger, so was the static!

FM signals do not depend on the conductivity of the earth for propagation as they are too short in wavelength to be affected by the earth. However, open flat land and water is conducive to the FM signal rather than mountains and tall city buildings. I have seen thunderstorms cause a distant FM signal to fade to noise; and although trees and forests are noted for attenuating UHF-TV signals, they can attenuate FM signals to a lesser degree. Mountains are the most fun with FM. I can remember hearing three or four

different stations on the same channel as I drove through the Smokies. I hope this gives partial answers to Steve Anderson and Vincent Paterno. Thanks for the letters.

C. R. McCard is upset by radio programming of today, saying the networks should take a larger part in programming the local stations as they did years ago. Well, they are, but it will take time (see August '84 Broadcast Topix).

Each network using satellites has the capability of giving many different sources for any type of format a station may choose. ABC radio now has a separate feed for each U.S. time zone. They can feed a football game on one channel, news programs on five others, a stereo concert on two others, a presidential news conference on still another and on and on, all simultaneously. Multiply this by CBS, Mutual, NBC, plus countless other services by AP, UPI, RKO, CNN, again, on and on. As I said before, this

## Call Letter Changes

Old Call	New Call	Location			
<b>AM</b>			new	KHRN	Hearne, TX
new	WLGC	Greenup, KY	new	WXRY-FM	Ridgeland, SC
new	KEUE	Oak Harbor, WA	new	KHHC	Seligman, MO
new	WEEG	Jefferson, GA	new	WITQ	Block Island, RI
new	WKLU	Midway, KY	new	KHJE	Ada, MN
KBAB	KXLQ	Indianola, IA	KELS	KEBQ	Ardmore, OK
WAQI	WAST	Ashtabula, OH	WAIL	WLTS	Slidell, LA
KWK	KGLD	St. Louis, MO	WLGC	WLGC-FM	Greenup, KY
KHNL	KKAI	Honolulu, HI	WRDB-FM	WNFM	Reedsburg, WI
KBMY	KUUS	Billings, MT	WDBS	WFXC	Durham, NC
W TSA	WMMJ	Brattleboro, VT	KXCU	KXCR	El Paso, TX
KSCR	KRIZ	Renton, WA	KADO-FM	KTWN	Texarkana, AR
KSKS	KMUV	Conroe, TX	WMMJ	W TSA-FM	Brattleboro, VT
KKSS	KMFY	Richfield, MN	WAXU-FM	WAXU	Georgetown, KY
new	KBCD	Sahuarita, AZ	WAVV	WCVK	Vevay, IN
new	WAIS	Buchtel, OH	WBJX	WLNK	Goose Creek, SC
			KMXL	KVFM	Logan, UT
			KDTA-FM	KLDR-FM	Delta, CO
<b>FM</b>			KFFV	KKYS	Bryan, TX
new	WYFH	N. Charleston, SC	new	WYRY	Hinsdale, NH
new	KVXO	Spokane, WA	new	KSMN	Truth Or Consequences, NM
new	KXJJ	Clifton, AZ	new	KTJC	Rayville, LA
new	WEKH	Hazard, KY	new	WTAA	Charleston, MS
new	KHUG-FM	Phoenix, OR	new	SGTK	Frostburg, MD
new	KENY	Soldotna, AK	new	KBBP	Sioux Falls, SD



## New From EEB

### Digital vs Analog Battle Is Over

The Winner Fluke  
New Fluke 70 Series combining digital & analog displays at low cost



**Fluke 73**  
**\$85**

Analog/digital display  
Volts, ohms, 10A diode test  
Autorange  
0.1% basic dc accuracy  
2000 - hour battery life  
3-year warranty

**Fluke 75**  
**\$99**

Analog/digital display  
Volts, ohms, 10A mA diode test  
Audible continuity  
Autorange/range hold  
0.5% basic dc accuracy  
2000 - hour battery life  
3-year warranty

**Fluke 77**  
**\$129**

Analog/digital display  
Volts, ohms, 10A, mA diode test  
Audible continuity  
"Touch Hold" function  
Autorange/range hold  
0.3% basic dc accuracy  
2000 - hour battery life  
3-year warranty  
Multipurpose holster



Dealer Inquiries Invited

## ESKA RX99PL NEW

Professional Receiver  
PLL-Synthesized AM/SSB  
99 Memories - AM PL DET.

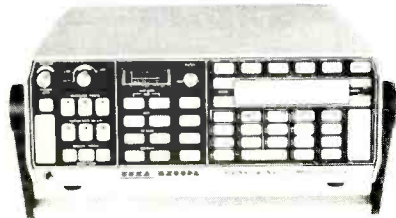

Hi tech from Europe never before available a receiver with so much  
Price range \$800-\$1500  
Delivery Dec. 1984

Free SWL Catalog  
Dealer inquiries invited



**BIRD** Electronics

East Coast's  
#1 Distributor

Complete Line Available

Call for quotes on all your Bird needs Dealer inquiries invited

**800-368-3270**



**Electronic Equipment Bank**  
(703) 938-3350  
516 Mill Street N.E.  
Vienna, VA 22180

## Station Updates

Freq.	Call	Location	Changes
<b>AM</b>			
600	KESR	Independence, CA	change power to 1 kw
750	new	Portage, TN	2.5 kw DA-D
820	KQIN	Burien-Seattle, WA	change frequency & power 50/5 DA-2
890	KVOZ	Del Mar Hills, TX	change frequency & power 10D/1N in kw
920	new	Midway, KY	500 w D
1020	WKQT	Garyville, LA	change frequency & power 50/.25 DA-2
1030	KBUF	Holcomb, KS	change frequency and add nite 1 kw DA-2
1130	WHHQ	Hilton Head, SC	add nite .5 kw DA-N
1140	WIXC		change city of license to Hazel Green, AL
1350	WCOP	Warner Robins, GA	DA-N with .5 kw
1420	WMYN	Mayodan, NC	power increase to 1 kw
1430	WBMK	Knoxville, TN	power increase to 5 kw
1460	new	Mount Holly, NJ	5 kw DA-D
1480	KAPE	San Antonio, TX	change frequency, DA-D with 2.5 kw
<b>FM</b>			
88.3	new	Topeka, KS	35 kw ERP at 238' HAAT
88.5	new	Charleston, SC	ERP 32 kw HAAT 581'
89.1	WCWM	Williamsburg, VA	change frequency to 90.7
90.5	KSCG	St. Peter, MN	change ERP to 75 kw & HAAT 708'
91.7	new	Augusta, GA	ERP 3.25 kw HAAT 800'
92.9	KWFM	Tucson, AZ	change ERP to 100 kw & HAAT to 2000'
94.9	KBZT	San Diego, CA	change ERP to 22 kw & HAAT to 701'
94.9	KSDM	International Falls, MN	change frequency to 104.1, increase ERP to 100 kw HAAT 365'
94.9	WPCH	Atlanta, GA	change HAAT to 968'
96.3	WGTF	Nantucket, MA	change ERP to 50 kw
97.3	new	Anchorage, AK	ERP 25 kw HAAT minus 15'
97.5	new	Agana, Guam	ERP 3 kw HAAT 991'
97.9	KNAX	Fresno, CA	change ERP to 50 kw & HAAT to 312'
97.9	WVCD	Hazleton, PA	change HAAT to 34'
98.1	KYKY-FM	St. Louis, MO	change HAAT to 644'
99.5	WLOL	Minneapolis, MN	change HAAT to 1294'
99.9	KEKB	Fruita, CO	change ERP to 79.4 kw
99.9	KTDY	Lafayette, LA	change HAAT to 984'
101.1	new	Russellville, KY	increase HAAT to 1010'
101.3	KFDI-FM	Wichita, KS	change ERP to 100 kw & HAAT to 1139'
102.3	WSUS	Franklin, NJ	change ERP to .592 kw
102.5	WHIZ-FM	Zanesville, OH	change ERP to 50 kw & HAAT to 495'
102.9	WIVY-FM	Jacksonville, FL	change HAAT to 660'
104.3	KBEQ	Kansas City, MO	change HAAT to 1052'
105.1	WUBE	Cincinnati, OH	change ERP to 14 kw
105.9	WKHQ	Charlevoix, MI	change HAAT to 903'
105.9	KQTZ	Hobart, OK	change ERP to 100 kw
106.1	WRFS-FM	Alexander, AL	change ERP to 27 kw & HAAT to 254'
106.1	KRPM	Tacoma, WA	change HAAT to 1480'
<b>SW</b>			
	KVOH	Rancho Simi, CA	new International Broadcast Station

is the dawning of programming via satellite. So take heart, C. R., I think help is on the way. However, local news will still be up to the local station.

The interesting aspect to the local station about multichannel programming is they only have to buy the decoders needed for the programs they want to receive. Some decoders are switch selected so the channels could be changed at will.

## FCC News

The FCC has determined there is no clear way to impose regulations that would be effective in controlling apparent loudness of commercial announcements of AM, FM, and TV stations, and therefore terminated its inquiry into the matter. What can I say? With so many types of limiting amplifiers on the commercial market today, it would be

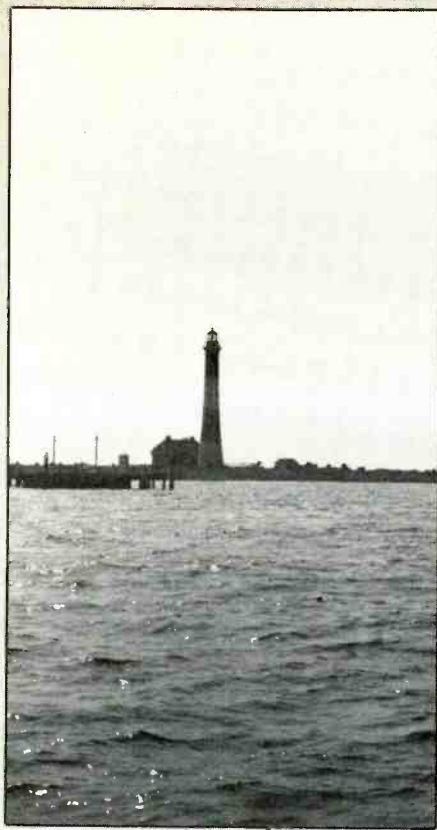

## First Broadcaster On Fire Island!

Daytimer WLIM (1580 kHz, 10 kW) of Patchogue, New York will soon be using the old Fire Island Lighthouse for the location of its antenna. The lighthouse has not been used as a light beacon for a number of years and has begun to crumble at the edges, although a private group has been trying to raise \$1.1 million to restore it as a historic site. WLIM, which specializes in an "oldies" program format of songs and show tunes, will be paying \$300,000 towards the restoration of the lighthouse for a ten year antenna lease. This makes it the very first broadcast station ever to be located on Fire Island (the top of the lighthouse is presently used to support several federal agency VHF antennas). The WLIM antenna will not mar the aesthetic value of the historic lighthouse. The new antenna site is expected to be in operation by late 1985 and marks the first commercial use of the structure, which is within the Fire Island National Seashore.

**Tony Earll, KNY2AE**

next to impossible to say this is the way to do it! The FCC is wise. I'll speak more about this in a later column.

The NAB (National Association of Broadcasters) has asked the FCC to reconsider its decision to get out of call letter disputes. The FCC said only about 10 percent of call letter requests were objected to, and less than 10 percent of these sustained. In view of this, the commission figures these disputes can be better handled in local courts and they

can better use the monies previously spent to police call letters.

The FCC has suspended the filing of new stations on Canadian clear channels 690, 740, 860, 990, 1010, and 1580 kHz. This is due to an agreement to allow stations within 650 miles of Canada to operate on these channels. By waiting till the end of the year or so, the FCC can better judge all new applications within and out of the 650 mile boundary to see who is the better qualified applicant.

As of May 31, the FCC said we have 4,747 AM stations; 3,594 FM stations; 1,144 educational FM stations; 351 UHF TV; 537 VHF TV; 173 educational UHF TV; and 112 educational VHF TV stations. In addition, there are 278 low power UHF, and VHF TV. This gives a total of 9,485 radio stations and 1,451 TV stations in the United States.

## Trivia

As a kid I was always trying different antennas to see how each worked in picking up the local station (see July '84 Broadcast Topix). To facilitate my experimenting, I made up a "pill box" crystal set pretuned to the local station (1240 kHz). The antennas might be the dial stop on the telephone, a rain gutter, the window screen (which were copper then), and as I remember the ground wire on telephone poles worked pretty well! Someday maybe I'll show you my bicycle crystal set complete with loaded whip and headphones. Sony thought they had something new with their walkman! Mine didn't require batteries!

Last month's trivia asked about the small triangles on AM radios. These triangles were supposed to mark 640 and 1240 kHz on the dial. Before the more recent "EBS" system, some stations were designated to change to 640 or 1240 kHz to broadcast emergency information in case of enemy attack. The rest of the stations were to sign off. The thought behind this was the enemy bombers would not be able to "home" in on a single station (city) if the signals from many on the same channel were confusing the readings of the homing gear. Of course, the chance of bombers homing in today has gone with the advent of the missile age. Today's stations broadcast a warning tone, which is followed by important information—anything from severe weather conditions to a national crisis.

This month's trivia question: What U.S. commercial/broadcast station, excluding SW, operates with the most output power today? Trick question? . . . See what you come up with—we'll match answers next month. If you argue with me, I'll give you equal time! Address correspondence to P.O. Box 5624, Baltimore, MD 21210, enclosing an SASE if you want a personal reply. If you work for a BC station, send along a picture with a coverage map and a brief story about the station. We like the old pictures as well as the current ones. Send an SASE if you want them returned. See you next month. **PC**

## RECEIVE RTTY/ASCII/CW on your Personal Computer



**RTTY/ASCII/CW MFJ-1225  
SWL COMPUTER \$ 69.95  
INTERFACE**

**FREE MFJ RTTY/ASCII/CW Software  
TAPE AND CABLE FOR VIC-20 OR C-64. ORDER MFJ-1225/  
MFJ-1264 FOR VIC-20 OR MFJ-1225/MFJ-1265 FOR C-64.**

Receives commercial, military, and amateur RTTY/ASCII/CW using your personal computer.

The MFJ-1225 Computer Interface plugs between your receiver and VIC-20, Apple, TRS-80C, Atari, TI-99, Commodore 64 and most other personal computers. Requires appropriate software.

Copies all shifts (850, 425, 170 Hz shift and all others) and all speeds. Automatic noise limiter suppresses static crashes for better copy. 2 LED tuning indicator makes tuning fast, easy, positive. 4 1/2 x 1 1/4 x 4 1/4 in. 12-15 VDC or 110 VAC with optional adapter, MFJ-1312, \$9.95.

## INDOOR TUNED ACTIVE ANTENNA

**MFJ-1020  
\$ 79.95**



MFJ-1020 New Indoor Active Antenna sits on your desk ready to listen to the world. Rivals, often exceeds, reception of outside long wire. Unique Tuned Active Antenna minimizes intermode, provides RF selectivity, reduces noise outside tuned band. Also use as preselector for external antenna. Covers 300 kHz to 30 MHz in 5 bands. Adjustable telescoping antenna. Controls: Tune, Band Selector, Gain, ON-Off/Bypass, LED, FET, bipolar circuitry. Phonojack for external ant. 6x2x6 in. 9-18 VDC or 9V battery. 110 VAC with adapter, MFJ-1312, \$9.95.

## REMOTE ACTIVE ANTENNA

54 inch remote active antenna mounts outdoor away from electrical noise for maximum signal and minimum noise pickup. Often outperforms longwire hundreds of feet long. Mount anywhere - atop houses, buildings, balconies, apartments, mobile homes, on board ship.

Use with any radio to receive strong clear signals from all over the world. 50 kHz to 30 MHz.

High dynamic range eliminates intermodulation. Inside control unit has 20 dB attenuator, gain control. Switch 2 receivers and auxiliary or active antenna. "On" LED. 6x2x5 in. 50 ft. coax. 12 VDC or 110 VAC with MFJ-1312, \$9.95.



**MFJ-1024  
\$ 129.95**

Order from MFJ and try it. If not delighted, return within 30 days for refund (less shipping).

**One year unconditional guarantee.**

Order yours today. Call toll free 800-647-1800. Charge VISA, MC. Or mail check, money order. Add \$4.00 each for shipping and handling.

**CALL TOLL FREE . . . 800-647-1800**

Call 601-323-5869 in Miss., outside continental USA, tech/order/repair info. TELEX 53-4590

**MFJ ENTERPRISES,  
INCORPORATED**  
Box 494, Mississippi State, MS 39762



# RADAR REFLECTIONS

## RADAR DETECTORS AND THEIR USE

BY JANICE LEE

### **Georgia Mayor And Two State Troopers Indicted**

Oakwood, Georgia Mayor Lamar Scroggs and a Georgia trooper have been indicted on perjury charges, and another trooper has been charged with violating his oath of office and influencing another state employee.

The charges were ledged recently by a Hall County grand jury following an investigation of the Gainesville trooper post and the law enforcement practices of the city of Oakwood.

The grand jury also concluded that a speed trap was conducted by some Georgia State Patrol troopers in Oakwood, but the officers were not named.

Scroggs and Trooper William J. Lewallen were indicted on perjury charges in connection with testimony they gave to the grand jury. The other man involved, Trooper John Hembree was indicted on four counts of violating his oath of office and one of influencing another state employee.

The investigation began when allegations of a speed trap arose after it was disclosed that the city of Oakwood made donations to the construction of an addition to the state patrol post in Gainesville.

District Attorney Bruce Udolf said that each of the charges filed against the three men are felonies, with perjury carrying a sentence of one to ten years in prison and each of the other charges carrying sentences of one to five years.

### **London, England — Police Radar Guns Are 'Consistently Accurate', Or Are They?**

Hand-held meters used by police to detect speeding motorists are consistently accurate, even though they cannot be made immune from radio interference! The results of a year-long study which tested about ten percent of the 341 devices in use where published early this month. The report concluded: "The probability of an inaccurate speed reading is extremely low if the device is used in accordance with instructions by a properly trained operator."

The hand-held radar speedometers which were introduced in 1977 have caused public concern. The study was in part the result of a successful appeal against a speeding conviction at Newport Crown Court in 1981.

### **Radar Appeal Denied**

The Michigan Court of Appeals recently refused to reconsider its ruling establishing

standards for the use of radar speedometer evidence.

The court merely said the application for rehearing, filed by the Gratiot County Prosecutor's Office, was "without merit."

The appeals court standards include requirements that the officer using the device have adequate training, that the device be in working order and that road conditions leave a minimum possibility of distortion.

### **Gull With Gall Better Than A Fuzzbuster®?**

Usually San Juan Capistrano, California, is known for its swallows, but it was some fancy wing work by a swooping seagull that helped a speeding motorist escape the long arm of the law.

California Highway Patrol Officer Craig Carlson was racing after a lawbreaker on wheels when a jam-up on the highway brought traffic to a halt.

"When I finally worked myself up to the head of the traffic snarl, there was this seagull flying right down on the deck and swooping back and forth across all four lanes, just like we are trained to do to slow traffic," Carlson said.

The gull with gall ignored the flashing red lights and sirens on the patrol car and just kept doing his thing, Carlson said.

"I was going about 5 mph, and it just wheeled right along side me and looked me right in the eye through the window. Then it swooped over to the other side of my unit and looked in the other window at me," he remarked with amazement.

When it was ready, and not before, the gull headed for Capistrano, where the swallows return every March 19th.

"You're not going to believe this, but that gull apparently knew exactly where it was going," he said. "It led us all for two miles down that freeway . . . then turned off toward the beach."

The speeder got off free as a bird!

### **Pennsylvania Judge Dismisses Speeding Ticket, Claims Officer Erred In Use Of Vascar**

A speeding ticket recently issued to a Middletown, Pennsylvania resident was voided last month by a Common Pleas judge who was convinced Media police erred in the way they used Vascar.

Judge Howard Reed ruled that James Nielsen, a self-employed carpenter, had been incorrectly ticketed for traveling 55 in a 35 mph zone because the Vascar used by

police made no allowance for human reaction time.

Nielsen's attorney, John Breen, called it a precedent-setting case which could affect the future of Vascar.

The carpenter was ticketed by officer James Bowen, a member of the borough's new traffic unit, formed in February following a \$161,000 federal grant.

After Nielsen appeared before a district justice and was fined \$87, he went home and devised a formula, based on the 3.7 seconds the machine said he took to cover a distance of 304 feet, which showed the machine could be inaccurate by as much as 24 mph.

Nielsen's case was built on the timing of the officer using the machine. The officer has to turn a switch when the car passes a designated point, he said.

"If the officer hesitates one second before turning the Vascar switch as the car enters the pre-selected 304 foot zone, the machine is off by 24 mph," Nielsen's attorney, John Breen told Reed.

Breen explained there is a section in the state code which requires a police officer timing a speeding car to track it for three-tenths of a mile.

If Vascar did that, we would have no complaint. But its calculation over a distance of only 304 feet leaves too much margin for error," the attorney said.

### **End Of The Road?**

Ed Rahill of Barrington, Illinois and Tim Montgomery of Fremont, Ohio, recently drove their modified Pontiac TransAm to victory in the Four-Ball Rally, a clandestine freeway race.

They raced 23 other cars from Boston to San Diego, winning in 35 hours, 46 minutes at an average speed of 86 mph.

The racers, who won \$10,000, got tickets in Ohio for failure to use a turn signal and in New York for using a police scanner.

Interesting note: They never did get a speeding ticket!

### **Waterford, New Jersey, Fighting Claim Of Unreliable Radar**

Responding to a court case recently that raised questions about the reliability of township police radar equipment, Waterford committeeman and public safety director John Rauscher said there is "no problem" with the machines used to detect speeders.

"I say unequivocally at this point that we have tuning forks (used to test radar units) and that the radar units have been certified

and calibrated," Rauscher said during a news conference.

Waterford police Chief Joseph Palladino also was present.

Rauscher said records for the past five years show the department's four K-55 radar units have been properly calibrated.

"As far as K-55 radar is concerned, there is no problem."

Rauscher criticized the comments of Waterford Municipal Court Judge Angelo DiCamillo in calling into question an estimated 200 pending speeding cases.

The judge's statements were made during an April 18 court session in which he dismissed an October 1983 speeding ticket.

DiCamillo said he would decide whether all speeding cases between October 1981 to January 11 this year, are valid.

The speeding charge DiCamillo dismissed involved radar testing records that were not immediately available, Rauscher said, though the records have since been found.

However, Waterford Patrolman Philip Mendel, who issued the ticket, testified before DiCamillo that a tuning fork needed to test his radar unit was missing last fall.

"Judge DiCamillo's actions and statements in court recently, I can only consider at this point to be irresponsible," said Rauscher.

DiCamillo's law office secretary said that "under judicial ethics, he is not allowed to make any comments whatsoever."

Rauscher also said he cannot understand how DiCamillo can rule on 200 speeding

tickets and make a decision on them based on hearsay representations," he said.

He also denied a statement attributed to another officer that the police department required officers to write a minimum number of tickets per month.

"The chief has assured me that to his knowledge there was no quota system," said Rauscher, who became public safety director in January.

### Louisiana TV Cameras To Survey Traffic

A traffic surveillance system will be installed on Interstate 10 in Louisiana to aid state police in monitoring accidents.

The three closed circuit color television cameras will be mounted on 50-foot towers on the west and east sides of the Calcasieu River Bridge and at the US 171 overpass. Video monitors, located at state police headquarters, will allow troopers to watch for traffic irregularities.

The state Department of Transportation and Development has contracted installation work to a Baton Rouge firm according to DOTD Engineer Specialist Don Tranhan.

Tranhan said the surveillance system is not a speed monitor but will "help state troopers to be on the scene of an accident much quicker."

The cost of equipment and installation is \$117,000. **PC**

*Janice Lee is the Editor of Monday, A.M., the newsletter of Electrolert, Inc.*

## Free Tool Catalog



Thousands of hard-to-find products for building, testing, and repairing electronics. Everything is easy to order by phone or mail. Most orders are shipped within 24 hours of receipt of order and all our products carry a 100% satisfaction guarantee.

**contact east Dept. 0321**  
7 Cypress Drive, Burlington, MA 01803

CIRCLE 78 ON READER SERVICE CARD

### POPULAR COMMUNICATIONS Back Issues Available

At present we have copies of all of our back issues available, commencing with the first issue (September '82). These can be ordered by mail at \$1.75 each September '82 through January '84, and \$1.95 February '84 on from Popular Communications, 76 North Broadway, Hicksville, NY 11801. Be sure to specify which issues you want to order.

## The Nation's SWL/HAM Headquarters!

**ege, inc.**

13646 Jefferson Davis Highway  
Woodbridge, Virginia 22191  
Just 25 minutes south of Washington, D.C.

Wash., D.C. area 643-1063  
In Virginia 800-572-4201

Store Hours: MWF 12 noon—8 p.m.; TThS 10 a.m.—4 p.m.



**R-2000**

**R-1000**

**R-600**

The R-2000 is an innovative all-mode SSB, CW, AM, FM receiver that covers 150 kHz - 30 MHz, with an optional VC-10 VHF converter unit to provide coverage of the 118-174 MHz frequency range.

### PANASONIC

Now in Stock  
RF 2200, RF 3100, RF 799, RF 9  
—Call for Introductory Prices—

### SONY

SWL Receivers in Stock  
Models 2002, 4800, 6500, 7600A  
—Call for a Good Deal—

Interested in RTTY/CW  
Reception with Your  
Computer for Under \$100?

Call Us About  
the New MFJ RTTY/CW Reader

### REGENCY

Full line of Scanners  
Handhelds, Mobiles, Base Stations  
—Call for Our Low Prices—

### BOOKS, ANTENNAS & ACCESSORIES

—In Stock—



### ICOM R71

A Commercial-Grade Receiver  
at a Not-So-Commercial Price  
—Call for Your Best Price—



**BEARCAT DX1000**  
LISTEN TO AM/USB/LSB/CW/FM  
**BEARCAT SCANNERS IN STOCK**

Send 60¢ in Stamps for Catalog  
Dealer Inquiries Invited

For Orders and Quotes—Call

**800-336-4799**

CIRCLE 6 ON READER SERVICE CARD



## INSIDE THE WORLD OF TVRO EARTH STATIONS

### *The Evolution Of Video Receivers*

**G**one are the days when video receivers were large, clumsy devices whose weight was almost a measure of cost. The modern video receiver, which is light, small and attractively packaged, today is the control station for a home satellite reception system.

All video receivers must share the same basic task in preparing the signal captured by a microwave antenna for viewing on a television or listening on a stereo. However, just as one may drive to the theater in a Porsche or a Volkswagen, so homsat enthusiasts can select from among basic or highly sophisticated receivers.

The 3.7 to 4.2 GigaHertz satellite signal after detection and amplification by a dish and low noise amplifier must be downconverted or lowered in frequency to 70 MegaHertz. This frequency is an industry standard and is almost always selected so that compatible, well-engineered, and available low-cost circuit elements can be chosen. Receivers next amplify and demodulate this downconverted signal so the original video and audio signals can be extracted.

Downconversion can be accomplished via single or double stages. Single downconversion of the satellite signal is accomplished by mixing it with a second artificially produced frequency. To illustrate, if 3648 MegaHertz is used for mixing with the 3700 to 4200 MHz signal, a range of frequencies from 52 to 552 MHz still carrying the satellite messages is produced. A filter set from 52 to 88 MHz, which is centered on 70 MHz and which has a 36 MHz bandwidth, will select one satellite channel. Then, if the mixing frequency is increased, additional satellite channels all having a 36 MHz bandwidth and 70 MHz center frequency will be selected by the filter as the difference frequencies are shifted. Using the available mixing frequency and constant filter or window is the standard method available to select or tune from channel to channel.

A dual conversion receiver accomplishes the same in two steps by first mixing a variable frequency with the satellite signal to select channels and obtain an intermediate frequency. For example, if 2820 MHz is combined with the 3.7 to 4.2 GHz signal, an 880 to 1380 MHz band is produced. A filter set between 900 and 936 MHz will select a 36 MHz band centered on 918 MHz. This can then be mixed with 978 MHz to produce a 70 MHz signal.

In the "old days," receivers had downconverters built in. Most modern home market receivers delegate some or all of the downconversion to a separate unit either part of or close to the low noise amplifier. In this fashion, expensive cable rated for high

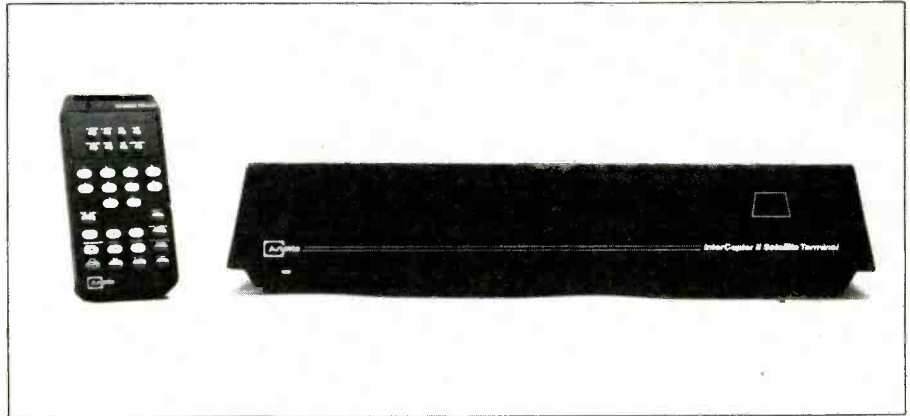

*The Arunta Interceptor II, satellite terminal.*



*The KLM Olympiad I.*

frequency transmission can be replaced by lower cost standard RG 59/U coaxial cable. As a result, minimizing the distance between the antenna and receiver is not as critical today as in the earlier days of satellite TV.

Following downconversion, filtering and amplification, a demodulation circuit extracts the original video information contained in a band from 0 to 4.2 MHz and the other various audio subcarriers in a band from 30 to 15,000 Hertz.

One major difference between receivers is in their bandwidth. The original audio and video information is relayed to space in a 36 MHz wide band. Lower quality receivers will look at only a small portion of this band in an attempt to minimize noise. However, while this approach works fine with the stronger satellite signals, it often results in poor picture quality on weaker responders.

This reduction of bandwidth is a simple and sometimes counterproductive method to lower the receiver's threshold. Signals having powers below threshold will be severely distorted. Today's best receivers have thresholds of 7.5 decibels, a measure of the ratio of signal to noise strengths. Receivers

are being developed which will have lower thresholds without decreasing the observed bandwidth. If a receiver could be built with a threshold of 4.5 decibels, an antenna with half the area could be used (so a 10-footer could be replaced with a 7-footer). In my estimation, these days are not far off.

Receivers can be differentiated on the basis of what method is used to select channels. Synthesized tuners use a single circuit element such as a crystal oscillator for each mixing frequency. Continuous tuners use a continuously variable element to select mixing frequencies. As a result, the receiver could be subjected to drifting off the center of any particular channel.

These basic features are supplemented by a host of "control center" options. Earlier receivers selected two audio subcarriers, typically 6.2 and 6.8 MHz. Many receivers now can tune the range from 5.8 to 7.5 MHz where most of the auxiliary audio services can be located.

Signal strength meters are available on some brands to give an indication of how accurately the dish and polarator are aligned with a particular satellite and transponder

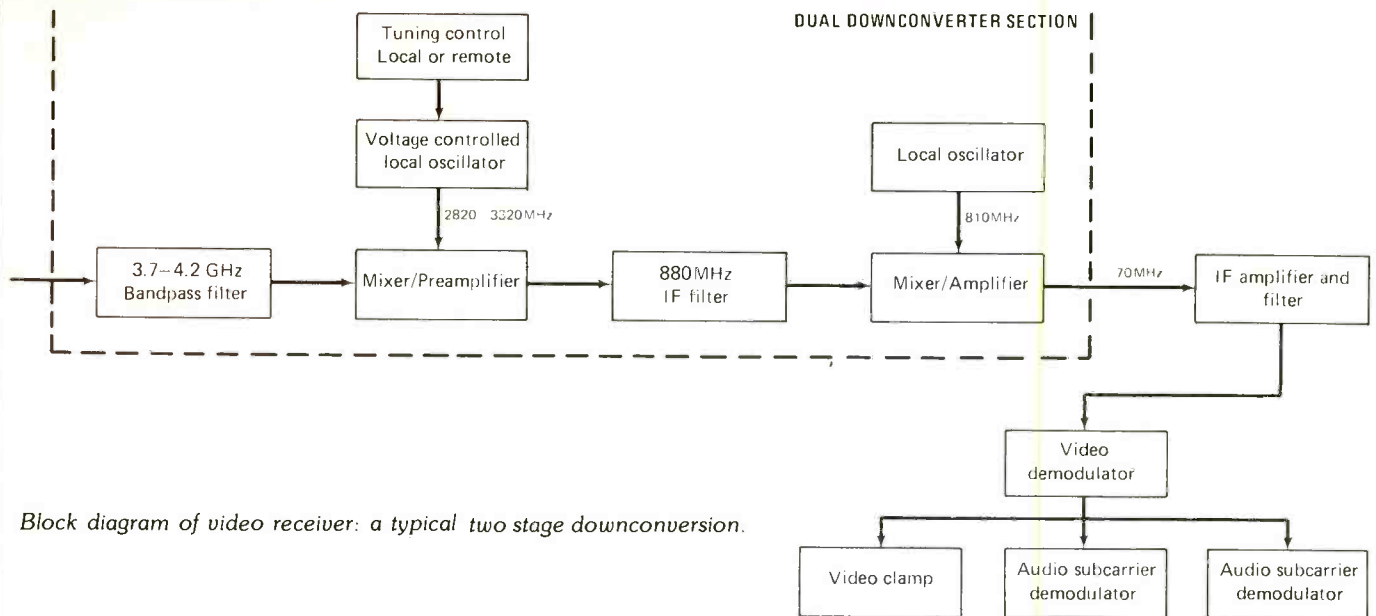

Block diagram of video receiver: a typical two stage downconversion.



Photo taken from satellite reception by Tom Harrington of Columbus, Ohio.

polarization. Many receivers have built-in polarity selection and a fine adjustment, called skew, which connects for variations in polarization direction from satellite to satellite. A tuning meter is often present to indicate whether a receiver is centered on a given transponder frequency.

A video-inversion switch can also be useful. Some satellite services in an attempt to scramble their programs simply invert the signal. A video-inversion selection overcomes this form of coding.

Speed scanning is used to automatically tune from channel to channel to allow a quick overview of the programs being relayed from any satellite. Some receivers scan rapidly until an active transponder is detected and then the picture is held for a longer period for viewing.

Many receivers now have built-in stereo processors to allow selection of mono or stereo sound. Earlier receivers also required the use of a separate modulator to prepare the baseband signal for a television. Most

units now have both baseband or modulated outputs (onto channels 3 or 4).

The remote control feature allows a user to control the television channel, dish pointing, polarity selection, etc. . . . from a simple keypad.

The new Arunta Interceptor II receiver is a prime example of the new breed of receiver/control centers. It is fully controlled from any room by a 32 button wireless remote keypad. A series of menu-guided commands which can be viewed directly on screen have been designed to facilitate its use. Both audio and video use quartz synthesized tuning. An "on-board programmable actuator" remembers up to 100 satellite names, positions, skew and polarity. It has a built-in stereo processor with selectable frequency response, 30-day timed programming of satellites, and "parental lockout" of any transponder on any satellite. At a more basic level, this receiver is a single conversion type to a 70 MHz intermediate frequency and has a 26 MHz (31 MHz optional) bandwidth.

An example of a back-to-basics receiver is

the KLM Olympiad I. It has continuous audio tuning, skew control knob to optimize polarity, a built-in modulator and signal polarity control. Incidentally, KLM also manufactures a number of more expensive, more sophisticated units.

This selection of video receivers is necessarily brief. Experts estimate that as many as 2000 brands of such devices are available for purchase in one form or another. The consumer has many choices.

The future also holds much promise. As circuitry is improved, receiver thresholds will drop allowing the use of progressively smaller dishes. Also, it is apparent that microprocessor technology will be incorporated into future generations of receivers. As seems to be the case with most electronic products, the real marvels are yet to come.

If you would like to learn more about satellite television, *Satellites Today, The Complete Guide to Satellite Television*, is available from ConSol Network, P.O. Box 12098-M, Boulder, CO 80303. The price is \$9.95 plus \$1.00 for postage and handling.

**TOTALLY AWESOME!**

Exotic and functional gear. Genuine military clothing for outdoors, survival and the street. Best quality at the right price. Satisfaction guaranteed. Send \$3.00 for your full year subscription to our color mail order catalog.

**U.S. CAVALRY**  
WORLD'S FINEST MILITARY EQUIPMENT

1375 N. WILSON RD. RADCLIFF, KY 40160 (502) 351-1164

Please send all reader inquiries directly.

**SHORTWAVE LISTENERS**

**YAESU SALE**

Get our latest **GARAGE SALE LIST!**

Contains sales, used gear and unique items. Send a self-addressed stamped envelope for each month you want.

FRG7700 AND ACCESSORIES	
FRG7700	\$399
ERA-active antenna	\$ 53
FRV-VHF converter	\$119
ERT antenna tuner	\$ 49

**Radio Shack** Catalog \$1.00 - Refundable  
3417 Purer Road  
Dept. PC  
Escondido, CA 92025  
call (619) 741-2891  
SALE ENDS 1/31/85

CIRCLE 39 ON READER SERVICE CARD



# PRODUCT SPOTLIGHT

## Operating Principles Of Voice Scrambling

The electronic voice scrambler dates back to World War II when the Allies used equipment unsophisticated by today's standards for securing strategic two-way radio and telephone communication. General use of scramblers by governments, public law enforcement agencies, and businesses began with development of adaptable, solid-state units in the 1960's.

Today, voice scrambler technology is the business of a few specialized companies worldwide. Controlonics Corporation is one of the most respected and significant of these companies.

The following are the basic encoding techniques employed in commercially available speech scramblers:

**1. Audio band inversion:** This amounts to turning the speech frequencies upside-down—transposing the "highs" with the "lows." Multi-code inversion designs use as their codes different insertion frequencies around which the inversion is done. Inversion is a simple and relatively breakable approach. It provides protection against casual and non-technical eavesdroppers; it is considered a short term or tactical protection. Most commercial scramblers employ inversion at one point in their scramble process. The Controlonics PD-101E is a multi-code inversion type scrambler.

**Band-splitting:** This simply amounts to cutting the audio frequency band into sub-bands and then shuffling them. A five-band splitter, for instance, would cut the two-way radio audio pass band into five 450 Hz sections. Splitting, seldom used alone and usually combined with inversion, is expensive to do well and adds little to real security level for the price paid.

**3. Tone masking:** This is the transmission of noise along with speech. Used alone, it does not provide an effective scramble. Used in conjunction with other techniques, its major asset is in covering some of the syllabic content (speech sounds). Masks may be as simple as a single frequency tone or as complicated as many tones changing during the course of the transmission. The major disadvantages of multiple-tone mask is that when filtered out, some voice frequencies are removed eroding the quality of recovered speech. Masking is used to do work other than scrambling; one job is to make the scrambler operation automatic, to allow clear reception of both scrambled and non-scrambled transmissions while the scrambler



*The Controlonics' Evader and Evader A.*

*Here are models PD-101E, PD-101E Sigma, and PD-201, all from Controlonics.*

is in use. The Controlonics PD-107 scrambler is a multi-code inversion scrambler with tone mask . . . it has the automatic decode feature. The PD-201 model also provides this feature.

**4. Sequenced code switching** is not really a scramble technique, but a very effective way of greatly increasing security level using one or several of the above basic techniques. A sequenced code switching scrambler switches from one coded condition to another throughout the course of a transmission. These scrambler types come in many configurations . . . frequency-hoppers are switching between several inversion frequencies . . . rolling-code band splitters are doing exactly what the name says. The approach of some scrambler manufacturers has been to throw all of the standard techniques in one sequenced code-switching design. They will feature a very large number of codes and long-term "repeatability" (time theoretically taken for any one code combination to occur twice) via "code key generators." There are several problems with these scramblers:

1. Security level or the scramblers' resistance to being "broken" is not necessarily enhanced by number of codes or repeatability; it is often degraded.
2. Indiscriminate use of multiple scrambling principles complicated by code generators is very costly - prices range from \$1,000 to \$12,000!
3. The complexity of these designs results in fragile equipment difficult to adapt to real-world radio systems.
4. Quality of decoded speech is often poor.

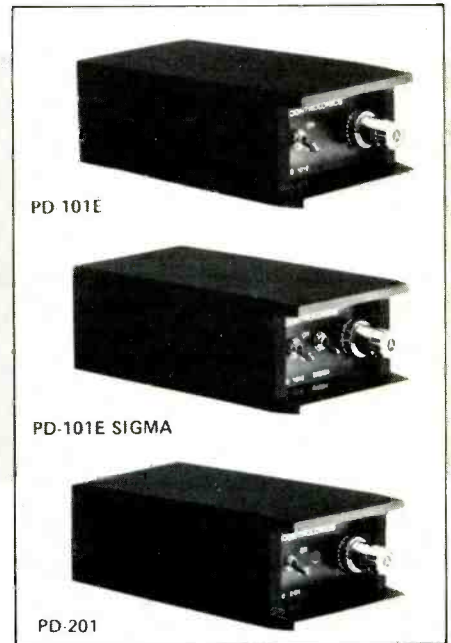

Effective use of the sequenced-code switching principle demands careful selection and combination of the basic scrambling techniques. The objectives are to produce an unintelligible, difficult-to-break scrambled speech, clear recovered speech, simple installation and operation, durability, and wide adaptability to today's radio systems. The Controlonics PD-101E Sigma and PD-201 scramblers achieve these objectives.

All the scramblers discussed thus far are frequency domain scramblers; they encode by transposing the speech frequencies in a variety of ways. Recent scramble developments involve different techniques.

**5. Digital Encoding:** This technique involves translating speech into straight "yes-no" computer-type language for transmission. Specifically, it is called "variable-slope delta modulation." The machine senses the changes in instantaneous amplitude of the speech wave forms and then digitally follows the changes in amplitude as they take place. Crude example of this: A digital scrambler uses a pulse to mean "up" in amplitude and a no-pulse to mean "down." As a speech waveform moves up in amplitude, a continuous series of pulses or "ups" are transmitted until the scrambler encoder locates the new and higher amplitude. The encoder then transmits pulse—"no pulse-pulse-no pulse" until the amplitude again changes. The decoder reads this



Controlonics' TDS-4000 Time Domain Scrambler System upgrades voice privacy systems, offering up to 384 mutually exclusive codes.

"pulse" and "no pulse" information to reproduce the desired amplitude. It is a dynamic approach, always hunting for and following the speech with its little up-up-up-pulses and down-down-down no-pulses.

The major disadvantages of the digital scrambler are its high cost plus a requirement for a wider band-width than is standard for two-way radio systems (special FCC approval for F 3-Y emission is required). Personality of recovered voice is seriously degraded. Digital scramblers are not retrofitable to existing two-way radio equipment.



The Portable Evader.

**6. Time domain scrambling:** The time domain scrambler uses analog delay lines—called "bucket brigades"—to store full speech in very short segments. The segments are then shuffled in time. The result is a very high level of scramble security.

Since time domain scrambling does not involve shifting of speech frequencies around inside the available audio pass band, it is adaptable to the wide variety of two-way radio equipment and systems. This translates into broad radio compatibility and excellent voice recovery.

*This material extracted from manufacturer's literature.*

# The Best \$38.95

AV-801  
Astro Scan™  
Tri-Band Monitor

■ Multiply your scanner power on the Low (25-50 MHz), VHF (140-174 MHz) and UHF (450-512 MHz) bands with this patented higher performance monitor antenna. Co-inductive 5/8 wave design for low band; full 1/2 wave dipole design for high band; and 1 1/2 wave collinear design for UHF. Easy to install, weighs only 2.25 lbs. Mounting mast and cable not included.

Avanti®

## MONITORS

### ALL BAND

MON-38 Magnet Mount	\$36.75
MONR51 Base Station	\$24.95
MONR31 Base Station	\$40.75
MON-64 Base Station	\$19.95

AV-801

**CB** Call us for Avanti parts and antennas by Hustler, HyGain, Mark & Avanti.

## H.C. Van Valzah Company

1140 Hickory Trail  
Downers Grove, IL 60515  
(312) 852-0472 or (312) 852-1469

CIRCLE 79 ON READER SERVICE CARD

**Over 75,000 active amateurs in over 125 countries throughout the world read and enjoy a different kind of ham magazine every month. They read CQ.**

**It's more than just a magazine. It's an institution.**

**SUBSCRIBE TODAY!**



The Radio Amateur's Journal  
76 North Broadway  
Hicksville, NY 11801

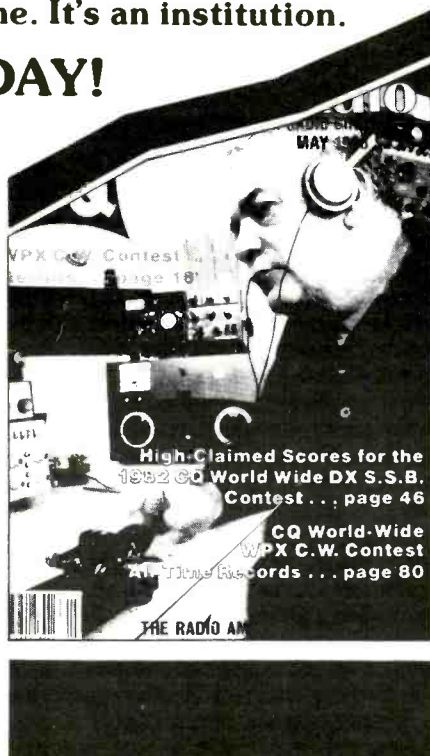

The Radio Amateur's Journal  
76 N. Broadway, Hicksville, NY 11801

Please send me CQ for  Life  3 Years  2 Years  1 Year  issue

New  Renewal Start with \_\_\_\_\_

Name \_\_\_\_\_ Call \_\_\_\_\_

Street \_\_\_\_\_

City \_\_\_\_\_ State \_\_\_\_\_ Zip \_\_\_\_\_

Charge My Order To:  Payment Enclosed \$ \_\_\_\_\_

MasterCard  My account number is \_\_\_\_\_

VISA  \_\_\_\_\_

3 Years (36 issues) ..... \$42.00  
2 Years (24 issues) ..... 29.00  
1 Year (12 issues) ..... 16.00



## THE EXCITING WORLD OF RADIOTELETYPE MONITORING

Several common misconceptions are evident about RTTY after noting the questions asked by mail. When we mention RTTY demodulator we are describing a unit for converting audio tones into binary ones and zeros. Often the term demodulator wrongly infers a built-in display driver. A terminal unit (TU) can infer demodulator, display driver, display, and possibly a keyboard. Since we require a display in order to watch RTTY, simple demodulators require a microcomputer, proper software, and monitor. For example, the new AEA CP-1 RTTY demodulator needs AEASOFT software (Advanced Electronic Applications, P.O. Box 2160, Lynnwood, Washington 98036) and a microcomputer to be complete. Specific microcomputers suitable for the CP-1 include the Commodore 64, VIC 20, Apple II, Heath H89, Atari 400/800/1200 series, TRS 80C, and the IBM personal computer. The computer and display interprets the demodulator's binary output into a printable character. Contrast the individual demodulator and display with the complete HAL CWR 6850 portable RTTY system (HAL Communications Corp., Dept JE, Box 365, Urbana, IL 61801). Ready to plug in and use, the CWR 6850 accepts an audio output from any suitable receiver and uses its built in 5 inch diagonal green CRT to display RTTY. In fact, field portable use is possible with the CWR 6850 since the system is fully powered from a 13.8 volt DC 1.6 ampere source. The difference between the complete terminal unit and a basic demodulator is one of personal choice and requirements.

Actually, there is a third variation on the demodulator/decoder/display theme. The Info-Tech M600-A system has the first two components—demodulator and decoder display electronics—but missing the third, an actual display. The fine M600A has built in display electronics but a CRT with a standard composite video is required.

If you choose, you can tap one of the unit's many output jacks and connect to a microcomputer for a simple display or hard copy output. A very nice feature of the M600A's decoder is the ability to convert all audio encoded RTTY/CW signals into standard garden-variety ASCII serial data. The beauty of this feature allows one to use all of the powerful microcomputer software on the market such as CROSSTALK XVI or PC TALK. The technical term used for this BAUDOT/CW to ASCII change is a protocol converter. Select call is built in to the M600A unit in order to "wake up" the terminal unit based upon a match of characters. The M600A is manufactured by Digital Electronic Systems, 1633 Wisteria Court, Englewood, FL 33533.

I recently purchased a small portable computer, the TRS Model 100 (marketed

```

NNNN
?IZC TRF
ANGLANI
.RBAATPS
MAP-28 --OMNISPORTS : KENYA.-
NAIROBI, 4 JUIL -(MAP).- LA SELECTION OLYMPIQUE DU KENYA POUR LES
JEUX OLYMPIQUES DE LOS ANGELES SERA COMPOSEE DE 65 ATHLETES, A
ANNONCE MARDI LE MINISTERE DES SPORTS.
LEQUIPE MASCULINE DIRIGEE PAR KIPCHOGE KEINO, CHAMPION OLYMPIQUE
DE 1500 M A MEXICO ET DU 3000 M. STEEPLE A MUNICH PRENDRA PART
A TOUTES LES EPREUVES DATHLETISMES. PAR CONTRE TANDIS-DUE LEQUIPE
FEMININE, COMPOSEE DE 7 ATHLETES PARTICIPERA AU 200 M, 400 M HAIES,
800 M ET MARATHON. (MAP).-
RH/ZM/
*** ATTN FIN DE NOTRE EMISSION EN FRANCAIS ***
*** VOICI RPT ***
VGXXY
Y18H15 FIN EMISSION FRANCAISE      OK OK ? ? ? ? ? ?
    
```

by Tandy/Radio Shack) for my RTTY shack. Coupled with a demodulator, this portable unit has several advantages—low noise, low power (battery powered), seven line by forty character display, built in cassette interface. The only catch is the need to write BAUDOT to ASCII conversion routines. I am not aware of any packaged RTTY software for the Model 100. Hopefully, commercial RTTY software will be out within a few months as this can be a dream RTTY station. Standard CMOS LSI chips (low power) are used throughout the circuit. Serial data is converted to parallel by an IM6402 Universal Asynchronous Receiver Transmitter (UART). Don't let the term asynchronous intimidate you. Asynchronous simply means serial data having a start and stop bit. Baudot and ASCII are both asynchronous data examples. Even schematics on the Model 100 may be had by ordering catalog 26-3810 (\$9.95) from Tandy. This is really a nifty machine for general communications.

For all the RTTY buffs, I would recommend the new Universal Shortwave Catalog (84-07). This catalog covers every phase of RTTY monitoring that one could think of including brief tutorials on shortwave listening and RTTY. A comprehensive selection of receivers, antennas, accessories, books, and parts is included for the communications enthusiast. A \$1.00 fee for the catalog is well worth it and is refundable with any purchase; send to Universal Shortwave Radio, 1280 Aida Drive, Reynoldsburg, Ohio 43068. New components are included, such as the Receiver Guard 2000. The 2000 is a fast RF overload protector for the front-end of a communications receiver.

A typical RF amplifier on a quality HF receiver is a MDSFET device—quite susceptible to damage by large voltage fields such as local transmitter or a lightning discharge nearby. Some receivers have built in protective circuits. My NRD515 receiver uses a basic back-to-back diode technique. Unfortunately, this technique offers much to be desired as cross modulation spurious signals crop up due to this inferior scheme. At least

using the Receiver Guard 2000 offers an alternative to the protect vs. increased cross-modulation dilemma.

Let's look at our readers' questions. George Osier encountered a snag. Using a Yaesu FR6-7700 with a 2.9 and 1.9 kHz Collins mechanical filter. George was told that a CW/RTTY demodulator will not work with the 1.9 kHz filter. Too narrow he was told. Well, George, I have to disagree since the 1.9 kHz Collins filter is ideal for general RTTY listening. Shifts of 170 Hz, 425 Hz, and 850 Hz will easily pass, including most significant harmonics, using a 1.9 kHz filter. A filter of 4 kHz is less than optimum as this will also pass adjacent signals and noise. A good choice is a 2.1 kHz to 1.8 kHz RTTY filter.

Jim Miller added receiver costs and demodulator costs together and is questioning the wisdom of spending over \$600 "only to find most of the RTTY information is in coded form." RTTY listening is an expensive hobby and a challenge to find non-encrypted RTTY signals in a collection of many encrypted signals.

The possibility of breaking encrypted military codes is nil. Some foreign military codes are readable but these are few and far between. This is not a simple, quick, or inexpensive hobby but, nevertheless, a fascinating unpredictable hobby.

F. R. Kennedy writes to correct our article in the July issue of POP'COMM:

Carnet frequencies—3235.0, 5937.0, 8130.0, 10950.0, 14395.0, and 16440 kHz

WMO frequencies—4061.5, 8140.0, 13624.0, and 18765.0 kHz

All broadcasts are 850 Hz shift, 100 WPM, and normal phase

Most of the broadcasts are coded groups preceded by a four letter identifier. A number attached to the call and a date/time group identifies the message. The usual format is: ZCZC WBC and three numbers, a four letter group identifying the information to be sent, the date/time group followed by usually five number groups and closing with eight line feeds and NNNN's.

PC

# NRD-515 COMMUNICATIONS RECEIVER

## GENERAL COVERAGE 100 KHz. to 30.0 MHz.

NOW THE ULTIMATE IS AFFORDABLE

**PRICE BREAKTHROUGH !!!**

**NRD-515 Receiver .1-30 MHz  
\$949.00**

**NDH-518 96 Channel Memory  
\$235.00**

**NCM-515 Keypad Controller  
\$175.00**

**NVA-515 External Speaker  
\$45.00**



For more information on this or other SWL products write to:

### UNIVERSAL SHORTWAVE RADIO

1280 Aida Drive  
Reynoldsburg, Ohio 43068  
Phone: 614-866-4267

The NRD-515 offers more features and performance than any other receiver in its class. Exceptional selectivity and stability make this an excellent radio for RTTY and FAX reception. Designed for the serious DXer who demands the best!

Please send all reader inquiries directly.

### DOUBLE YOUR RANGE Metz Tuned Base-Loaded Whips

Replace Your Telescopic Whip With The Metz System. Metz Whips Plug Into Your External Antenna Connector. Right angle SO 239 supplied. For scanners use Radio Shack 278-208 adapter. Bracket supplied for outdoor mounting.

- Two Models: Scan 1 covers 30 MHz to 512 MHz  
SW 1 covers 50 kHz to 54 MHz
- All stainless steel—won't corrode
- Tuned coils offer 3 dB gain over telescopic whips
- Every coil tested and serialized
- No external power required
- Whip only 54" tall
- Antenna may be mounted mobile with accessory \$25.00 magnetic mount
- Cannot be damaged by lightning



Metz stainless steel antennas are used worldwide by Mariners, Police, Business, and Commercial Radio users. It was the Ham Radio operators who discovered the phenomenal range increase when used on Ham worldwide and VHF equipment. Well-known radio expert Gordon West, WB6NOA, gives the Metz whips his highest rating: "They equal the range of active antenna systems at one-third cost, and when you replace your telescopic whip with the Metz, you'll really hear the difference!" \$59.95 from Metz Communication Corp.

Metz Communication Corp.  
corner Rt. 11 & 11C,  
Laconia, NH 03246  
Phone Orders Only:  
800-258-4680

(Visa/MasterCard/C.O.D.)

Shown mounted directly to receiver with supplied adapter. Absolutely No Personal Checks  
Technical Info: 603-528-2590  
Amateur antennas for 2 Meter & 440 MHz also available

Please send all reader inquiries directly.

### QUALITY PARTS AT DISCOUNT PRICES!

<b>SUB-MINIATURE D TYPE CONNECTOR</b>  SOLDER TYPE SUB-MINIATURE CONNECTORS USED FOR COMPUTER HOOK UPS DB-15 PLUG \$2.75 DB-15 SOCKET \$4.00 DB-15 HOOD \$1.50 DB-25 PLUG \$2.75 DB-25 SOCKET \$3.50 DB-25 HOOD \$1.25	<b>KEY ASSEMBLY 5 KEY</b>  \$1.00 EACH CONTAINS 5 SINGLE-POLE NORMALLY OPEN SWITCHES. MEASURES 3 3/4" LONG. <b>6 KEY</b>  \$1.25 EACH CONTAINS 6 SINGLE-POLE NORMALLY OPEN SWITCHES. MEASURES 4 1/4" LONG.	<b>COMPUTER POWER SUPPLY</b>  USED TO POWER A COMMODORE COMPUTER. THIS SUPPLY DELIVERS BOTH 5 VDC @ 6 VA (APPROX 1.2 AMPS) AND 9 VAC @ 5.4 VA \$10.00 EACH
<b>"PARALLEL" PRINTER CONNECTOR</b>  SOLDER STYLE 36 PIN MALE USED ON "PARALLEL" DATA CABLES \$5.50 EACH	<b>CRYSTAL</b> CASE STYLE HC33/U COLORBURST 3579 545 KC 2 MHZ \$3.50 EACH \$1.00 EACH	

FREE! FREE! FREE! SEND FOR NEW 1984 48 PAGE CATALOG

<b>MINIATURE TOGGLE SWITCHES</b> ALL ARE RATED 5 AMPS @ 125 VAC S.P.D.T. (on-on) \$1.00 EACH S.P.D.T. (on-off) \$1.00 EACH P.C. STYLE, NON-THREADED BUSHING 75c EACH 10 FOR \$7.00	<b>SOLID STATE BUZZER</b> STAR #SMB 06L 6 VDC TTL COMPATIBLE \$1.00 EACH 10 FOR \$9.00	<b>EDGE CONNECTORS</b>  22/44 22/44 GOLD PLATED CONTACTS .156 CONTACT SPACING \$2.00 EACH 10 FOR \$18.00
S.P.D.T. (on-on) \$1.00 EACH P.C. STYLE, NON-THREADED BUSHING 75c EACH 10 FOR \$7.00	<b>120V INDICATOR</b> NEON INDICATOR RATED 120 V 1/3 W MOUNTS IN 5/16" HOLE 75c EACH 10 FOR \$7.00 100 FOR \$65.00	<b>5 STATION INTERLOCKING</b> MADE BY ALPS 3-2PDT AND 2-6PDT SWITCHES ON FULLY INTERLOCKING ASSEMBLY 3/4" BETWEEN MOUNTING CENTERS \$2.50 EACH

### ALL ELECTRONICS CORP.

905 S. VERMONT • P.O. BOX 20406 • LOS ANGELES, CA 90006

TOLL FREE ORDERS • 1-800-826-5432  
(IN CALIFORNIA: 1-800-258-6666)  
AK, HI, OR INFORMATION • (213) 380-8000

● QUANTITIES LIMITED ● FOREIGN ORDERS INCLUDE SUFFICIENT SHIPPING ● USA: \$2.50 SHIPPING NO C.O.D. ● CALIF. RES. ADD 6 1/2%

5 STATION NON-INTERLOCKING  
SAME AS ABOVE, EXCEPT EACH SWITCH OPERATES INDEPENDENTLY \$2.50 EACH

CIRCLE 32 ON READER SERVICE CARD



# PIRATES DEN

BY DARREN LENO, WDØEWJ

## FOCUS ON FREE RADIO BROADCASTING

**T**here is an interesting, if not refreshing, new voice on the pirate airwaves today. It's the outspoken, mobster-accented voice of Rocco Giuliano and his interpretations of . . . just about everything.

Rocco is the star of a weekly, five minute long syndicated radio program called "Verbal Assault." It is a well produced show currently being circulated among pirate broadcasters. It can even be heard on a few legal college and progressive radio stations around the country. The list of pirate stations that carry "Verbal Assault" includes Radio Free Augsburg in West Germany, Music Radio in Holland, the Voice of Venus, Fantasy Broadcast Service, and others.

I recently had the chance to conduct an interview with Rocco and his producer/sidekick, Joe Tyburczy.

In Rocco's own words, the goal of "Verbal Assault" is to "instill in its listeners a sense of reality." "Reality" according to Rocco, makes for amusing, different, and (dare I say) enlightening listening. He rambles at length about trivial social details, offers obscene solutions, and is prepared to verbally assault anything that gets in his way. But at the same time, his program is far from being "disgusting." It's a sense of humor that can be identified with, but does not copy, the original *Saturday Night Live* TV programs.

During the course of the interview, I made the mistake of asking whose idea it was to begin "Verbal Assault," and what inspired it.

Rocco pounced on the question and gave an answer that was so long I would have had to drop the pirate loggings this month to accommodate it. Rocco is not one to use five words to say something when he can say it in twenty.

In true Rocco fashion, he said "That's a good question, because it gives me a chance to talk about myself. Actually, the 'idea' goes back to the 1960's, at which time I made the decision to communicate my sense of reality by some form of mass media.

"My first paying job was on a 10,000 watt AM station in Central Massachusetts, writing and producing commentaries and editorials, ostensibly on public issues like deficit spending and air pollution, which, to me, falls in the category of 'nuts and bolts.' So, I incurred the wrath of the station management by concentrating on my own philosophical concepts and an occasional excursion into my own pet peeves, like plants, runners, umbrellas, etc. This led to a falling out with my employers which culminated, literally, with threats of violence, drawn guns, and the intervention of security personnel, who escorted me from the studio in handcuffs."

After this little incident, so the story goes, Rocco decided he had to go into business for



Here is a rare picture of none other than "Verbal Assault's" Rocco Giuliano.



himself. He met his current producer, Joe Tyburczy, then an unemployed filmmaker "whose ambition in life was to produce a feature-length, animated version of *Hamlet* in a medium known as 'claymation.'"

But to this day, Joe maintains it was he who discovered Rocco "in the squalor of a rented room, yelling into the battered remains of an RCA DXC-44 broadcast microphone" which used to belong to a certain 10,000 watt radio station. So the story goes on and on.

Most listeners who have had the opportunity to hear "Verbal Assault" agree: it is a very professional sounding production. And yet it is only one aspect of what can be heard on pirate broadcast stations today.

If anyone who works at a radio station is interested in learning more about "Verbal Assault," I asked Rocco what they should do. I got the following answer: "I don't know and I don't care. What anyone does or doesn't do is his or her own problem, and I'm not interested in other people's problems. I have my own problems, which I fortunately have people to deal with for me."

Joe Tyburczy was a bit more helpful, and stated, "Interested stations (legal or pirate) should write to the Verbal Assault Syndication Dept., Dept. PC, Box 619, Hudson, MA 01749."

A complete, unedited copy of the interview with "Verbal Assault" can be obtained by writing to the Association of Clandestine radio Enthusiasts, PO Box 452, Moorhead, MN 56560. Send \$1.50, and ask for the "Verbal Assault" issue of *THE ACE*.

### Laser 730 Is Now Laser 558

Walter Haller checks in this month with an update on the British offshore pirate scene. Laser 730, a rival to the famous Radio Caroline and broadcasting from the ship *My Communicator*, is having problems with the British Telecom, England's version of AT&T. "Dear Darren,

"I'm in the US Air Force stationed in the United Kingdom. I'm writing in regards to the item about Laser 730 in the June, 1984, *Pirates Den* column.

"A station with a similar name was operating for a few weeks toward the end of May, and ending the second week in June. But they were on 558 kHz and not 730 kHz as planned. A jingle identified the station as 'Laser 558, transmitting from international waters.'

"I tried to place a call to them by SW ship-to-shore telephone, but to no avail. The British Telecom supposedly could not locate the *MV Communicator*, the ship Laser 558 said they were broadcasting from. With much persistence, British Telecom said that the *Communicator* was equipped to receive satellite calls via INMARSAT. The number they gave me was 1330442, but after many attempts and no results, the operator passed me on to INMARSAT headquarters.

"INMARSAT informed me that service had been withdrawn from *MV Communicator* because it was 'contravening numerous maritime regulations' and that British Telecom was vigorously pursuing this matter!"

Walter says that INMARSAT calls for the *MV Communicator* originating from the United States should get through.

### Pirate Bandscan

**KLS:** This was heard from 0210 to 0230 GMT by George Zeller of Ohio Programming consisted of hard rock vocal and instrumental music. George says the station's modulation was good, but that 7440 kHz was plagued with interference and made copy difficult.

**KQRP:** This pirate continues to be heard (and heard and . . .) by many SWLs. Frequencies to watch for this station's activities include 6208 kHz, 7405 kHz, 7413 kHz, 9930 kHz, and 11610 kHz, weekend evenings. KQRP frequently operates parallel frequencies. On a recent 7425 kHz broadcast, I heard this station sign off suddenly due to a thunderstorm.

# RADIO CONFUSION

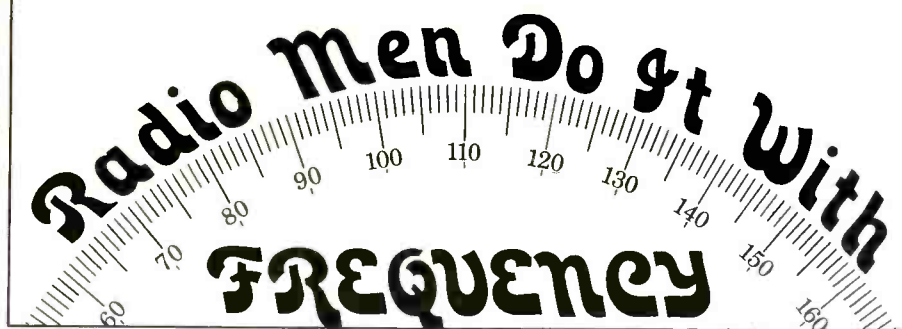

Radio Confusion used to send these bumper stickers to listeners.



Walter J. Haller, serving with the USAF in England.

**Radio Blotto:** "The station of topographic maps" was logged by Joe Wosik of Illinois on 7425 kHz after 0541 GMT. The DJ was announcing 3000 watts.

**Radio Ganymede:** This was noted by Joe Farley of Illinois on 7375 kHz after 0400 GMT identifying itself as the "Voice of the Ganymede Empire."

**Radio Sine Wave:** Tim Tyler heard this pirate on 7430 kHz playing the "Nat'l anthem of Microchip City." Dr. Copywrite was reading a spoof newscast.

**Secret Mountain Laboratory:** I managed to snag the tail end of a broadcast by this pirate on 7430 kHz. SML was playing banjo music. QSLs should be sent to PO Box 5074, Hilo, HI 96720.

**Voice Of To-Morrow:** Al Spremo of New York reports that this station recently announced a new address—PO Box 20039, Ferndale, MI 48220. Al logged the VOT on 6240 kHz after 0000 GMT.

**Voice Of The Vigilante:** Tom Brennan of Indiana noted this new pirate on 3445 kHz from 0315-0330 GMT. They played rock music and said they were testing. Another frequency to keep an eye on (or an ear to) for this station is 14585 kHz. Reception reports go to PO Box 982, Battle Creek, MI 49016.

**WBBH:** Arthur Pym of DC tuned this pirate on 4860 kHz after 0015 GMT. Folk mu-

sic was heard until sign off when the station identified itself. "This is a test transmission of WBBH. WBBH transmits on a frequency of 4860 kHz in the 60 meter band and is owned and operated by the Courtland School of Music in Rutgers, NJ." (This was the ID of a famous old time pirate not heard in 18 years. Sounds like someone's having a little fun! Editor.)

**WILD:** Kirk Allen of Oklahoma says WILD was plagued with QRM when he tuned into them on 7425 kHz after 0250 GMT.

**WIMP:** "Rock radio for the Midwest!" That's what Christos Rigas of Illinois heard when he tuned into WIMP on 7434 kHz after 0240 GMT. Reception reports can go to PO Box 982, Battle Creek, MI 49016.

## FCC Destroys Illegal Equipment

In a June press release, the FCC reported that its Norfolk District Office destroyed illegal radio equipment valued at nearly \$12,000.

On the list of casualties were CB linear amplifiers, including ham amplifiers with 10 meters, VFO's, transmitters, and other equipment too hideous to list here.

Most of the equipment was seized in FCC raids after search warrants were issued.

In a show for the press, the illegal equipment was crushed into scrap metal at the Norfolk Recycling Company in Norfolk, Virginia "under the watchful eye of the FCC."

## In Conclusion . . .

The First Edition of the *Free Radio Handbook* has been published by Brick-Through-Your-Window Publications. This little underground booklet outlines how pirate broadcasters take to the air and discusses the Free Radio Movement. The cost is \$2.00 cash to PO Box 5074, Dept. PC, Hilo, HI 96720. A very interesting production.

PANAXIS Productions, Dept. PC, PO Box 130, Paradise, CA 95969, sells part 15, and not-so-part-15 broadcasting transmitters. Send a large SASE for details.

Thanks are due this month to the contributors listed above, with special thanks to the Association of Clandestine radio Enthusiasts and Rocco and Joe at "Verbal Assault."

Your input and contributions are most welcome. Please send reproductions of your QSL cards, current loggings, tips, etc., to The Pirates Den, 76 N. Broadway, Hicksville, NY 11801.

Remember that most of the stations listed above broadcast on local Friday, Saturday, or Sunday evenings. The most active frequency range is from 7350 to 7450 kHz. Make sure you keep your receiver on during major holidays, including Halloween, Christmas, New Year's, and the Fourth of July. Good DXing! **PC**

### METERS FOR R-390A

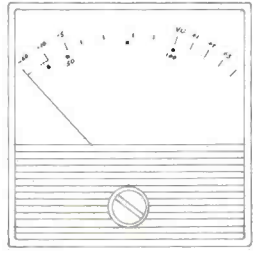

- Mechanical and Electrical drop-in replacements for meters removed from R-390A and R-389 receivers
- New Manufacture
- Offered in sets of two (Line Level shown)
- Price \$60.00/set
- Meters for other equipment available soon
- Write, call, or check reader service card for the latest catalog

**N.E. Litsche**  
P.O. Box 191 • Canandaigua, NY 14424  
716-394-0148

## Enjoy Your Radio Hobby



Now Available  
144 Page Book  
Covering U.S. Canada  
& Worldwide Shortwave  
AM, FM & TV Stations  
Cross-indexed by  
Frequency, Location & Call Letters  
A DXer's Delight for 60 Years

Only \$6.35 (ppd)

SEND FOR YOUR  
COPY TODAY!

NAME: \_\_\_\_\_

ADDRESS: \_\_\_\_\_

CITY: \_\_\_\_\_

STATE: \_\_\_\_\_ ZIP: \_\_\_\_\_

CLIP AND MAIL COUPON TODAY TO:

**WORLDWIDE PUBLICATIONS INC.**

P.O. BOX #5206, NORTH BRANCH, N.J. 08876

(201) 231-1518

Please send all reader inquiries directly.



## ESTABLISHING SURVIVALIST COMMUNICATIONS SYSTEMS

### Emergency/SAR Communications In The Desert

**H**ow many times have you heard of people becoming stranded in the desert and are later found dead of heat exhaustion? This has happened often in California's Colorado desert, which borders Mexico on the south and the Colorado River on the east.

Search and Rescue operations are varied throughout this area during the peak summer period when the thermometer registers a sizzling 135 Fahrenheit. If you don't know about desert survival, chances are you will become a victim of the treacherous desert terrain.

According to the survival pamphlet distributed by Imperial County, California's De Anza Rescue Unit... "Heat and dehydration are killers of the unprepared." DARU was founded and incorporated in May, 1969 following the tragic search at Mount Signal in Southern California's Imperial Valley for seven-year-old Keith Riley. The unit was founded with the consent of the Imperial County Sheriff's Department and operates under the guidelines set forth by Sheriff Oren R. Fox. DARU also cooperates with Mexican state and federal authorities during searches of the rugged Baja California desert terrain for lost or missing campers, pilots, or motorcyclists.

Since its beginning in 1969, DARU has grown to a well-equipped and highly trained rescue organization with an emphasis on emergency communications to assist in their efforts to find people. Because of DARU's sophisticated communications system, it has been possible to find lost victims and to bring them out of the desert alive.

DARU Communications officer Ben Green (WD8CZP) says that a communications emergency occurs when normal lines of communication are disrupted to the point of oversaturation and are overloaded or physically damaged to where they are inoperative. Green, who has served with the U.S. Navy for the past 12 years, says... "Your main purpose in a communications emergency comes at such a time when an organization such as DARU can be totally self-sufficient and self-supporting and becomes your main operational focal point for whatever agency is utilizing it—be it the Red Cross, the sheriff's office, the police department, or the fire department."

Amateur radio helps during emergencies, too. There are eight hams who work on a volunteer basis with the De Anza Search and Rescue Unit. Green believes that amateur radio is most effective because of its numerous personnel who have access to inexpensive radio equipment. The members of this elite group are available on an on-call basis. These hams can operate off a variety of fre-



*There are eight full time sheriff dispatchers for the Imperial County Sheriff's Department. This dispatcher is busy talking to a deputy in the field and at the same time keeps in contact with the Reporting Party of a crime on the telephone. (Courtesy Benjamin Green.)*



*Imperial County Sheriff's Department Communications Supervisor Terry Romero dispatches a call. The sheriff's communications center, south of El Centro, California has three identical consoles. Each is capable of dispatching on the All Valley Law Enforcement frequency (155.130), the California Fish and Game Department (151.430), all Imperial County fire department channels and the California Highway Patrol channels (42.340 BASE and 42.180 MOBILE). The sheriff can also contact De Anza Rescue on their own frequency (155.160) or through the CLEMARS channel (154.920). (Courtesy Benjamin Green)*

quencies and through many different modes of operation.

DARU is strictly a volunteer group with close to 24 active members who supply their own personal equipment such as radio gear and vehicles... including aircraft and boats. The fact that it is a volunteer group does not necessarily mean that they are not bound by rules and regulations. It does, however, give DARU the freedom of choice and movement across political and jurisdictional lines.

The unit has been involved with a multi-

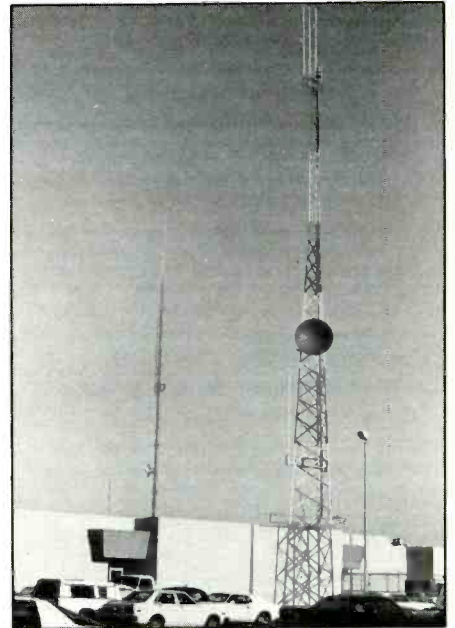

*The vast array of communications capable through the sheriff's department console is backed up by the giant antenna system behind the sheriff's department main office on Applestill Road three miles south of El Centro, the Imperial County seat. (Courtesy Benjamin Green)*

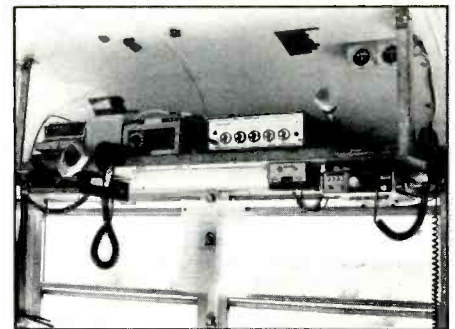

*De Anza's MOBILE communications base operations unit is set up in a Ford F-200 bus which travels throughout Imperial County on Search and Rescue missions. (Courtesy Benjamin Green)*

tude of Search and Rescue efforts in Baja California, Mexico. DARU also falls under the jurisdiction of the Imperial County Office of Emergency Services for special rescue and disaster operations. The situation in Imperial County is such that the unit seems to be the only such rescue agency at the present time that thrives on communications variables.

The variety of radio gear that is at DARU's disposal enables the rescue unit to operate in a different capacity according to whatever

## Imperial County Sheriff Radio Codes

10-1	RECEPTION POOR	10-27	DDL REQUEST	11-41	AMBULANCE REQUIRED
10-2	RECEPTION GOOD	10-28	REGISTRATION REQUEST	11-44	CORONER REQUIRED
10-3	CHANGE CHANNELS	10-29	CHECK FOR WANTED	11-48	FURNISH TRANSPORTATION
10-4	MESSAGE RECEIVED	10-30	DOES NOT CONFORM TO REGULATIONS	11-66	DEFECTIVE TRAFFIC SIGNAL OR SIGN
10-5	RELAY TRAFFIC	10-34	ASSISTANCE REQUIRED AT OFFICE	11-79	ACCIDENT-AMBULANCE SENT
10-6	BUSY, STAND BY	10-36	CONFIDENTIAL INFORMATION	11-80	ACCIDENT-MAJOR INJURIES
10-7	OUT OF SERVICE	10-36A	ARMED	11-81	ACCIDENT-MINOR INJURIES
10-7A	OUT OF SERVICE-HOME	10-36F	FELON	11-82	ACCIDENT-NO INJURIES
10-8	IN SERVICE	10-37	IDENTIFY OPERATOR	11-83	ACCIDENT-NO DETAILS
10-9	REPEAT	10-39	MESSAGE DELIVERED	11-84	DIRECT TRAFFIC
10-10	OFF DUTY	10-97	ARRIVED AT ASSIGNMENT SCENE	11-85	TOW CAR REQUIRED
10-13	ADVISE WEATHER & ROAD CONDITIONS	10-98	AVAILABLE FOR ANOTHER ASSIGNMENT	11-98	MEET
10-15	PRISONER IN CUSTODY	11-7	PROWLER	11-99	OFFICER REQUIRES ASSISTANCE
10-17	PICK UP PAPERS	11-8	MAN DOWN	CODE 2	URGENT
10-18	BACK-UP/ASSIST THE OFFICER AT _____	11-10	TAKE A REPORT	CODE 3	EMERGENCY
10-19	RETURN TO STATION	11-12	LOOSE STOCK	CODE 5	STAKE OUT
10-20	LOCATION REQUESTED	11-24	ABANDONED VEHICLE	CODE 7	CUT OF SERVICE (MEAL)
10-21	TELEPHONE	11-25	TRAFFIC HAZARD	CODE 33	CLEAR RADIO CHANNELS FOR EMERGENCY TRAFFIC
10-21A	TELEPHONE HOME	11-27	DDL REQUEST WITH DRIVER DETAINED		
10-22	CANCEL	11-28	REGISTRATION WITH DRIVER DETAINED		
10-23	STANDBY				
187 (PC)	MURDER	415 (PC)	DISTURBING THE PEACE	10851 (VC)	AUTO THEFT
207 (PC)	KIDNAPPING	459 (PC)	BURGLARY	20001 (VC)	FELONY-HIT AND RUN
211 (PC)	ROBBERY	594 (PC)	MAL MISCHIEF	20002 (VC)	MISDEMEANDR-HIT & RUN
288 (PC)	SEX PERVERSION	647F (PC)	INTOXICATION	22350 (VC)	SPEED
261 (PC)	RAPE	11500 (H&S)	NARCOTIC VIOLATION	23101 (VC)	FELONY-DRUNK DRIVING
314 (PC)	INDECENT EXPOSURE	5150 (W&I)	MENTAL	23102 (VC)	MISDEMEANDR-DRUNK DRIVING

SUFFIX LETTER "X" WILL BE USED WITH ANY CODE SIGNAL WHEN A FEMALE IS INVOLVED, (11-48X= FURNISH TRANSPORTATION-FEMALE)



Fifty sheriffs patrol cruisers are equipped with 8-channel GE radios with the basic channels of one, three, and five for the sheriffs office main link, but The ICSO Emergency Communications Van is equipped with not only the GE unit capability but also a sensitized 32 channel programmable Motorola Syntor X plus an 8-channel GE Master 2. (Courtesy Benjamin Green.)



De Anza Search and Rescue team member keeps contact with searchers in the field. (Courtesy Ed Goodell)



Imperial County Sheriff's Department helicopter (Eagle One). (Courtesy Ed Goodell)

the situation calls for. A lot of places have that capability, particularly the midwest. But most communities there operate a single band unit under the auspices of a county office of Civil Defense or the Red Cross. People in the midwest usually have some type of natural disaster every year with the onslaught of floods, hail, and tornadoes. In Imperial County, California, that is not necessarily the case. Other California communities have an emergency communications network where the local potential for natural disaster is greater, or magnified to a greater extent.

On September 9, 1976 the rains came to Imperial County. Tropical Storm Kathleen unleashed her fury on Southern California,

creating problems that were unique for a desert rescue mission. The very next morning, all the washes were full and running over their banks. City streets in El Centro, the county seat, were running with the torrent of a river, and local businessmen and residents were hurriedly sandbagging to protect their property and personal possessions from the running water. Although total rainfall from the storm was somewhere around three and a half inches, for a flat desert where it doesn't rain that much, this is sufficient to rapidly create flash flooding conditions. By the early morning of September 10, most of the highways throughout the county and city streets in various communities were closed to normal traffic.



### Frequencies for Imperial County Sheriff's Department

	Transmit Channel	Receive Channel	Location Of Repeater
Channel 1:	154.890	156.030(R)	Superstition Mountain
Channel 3:	155.370	154.845(R)	Black Mountain
Channel 5:	155.415	154.995(R)	Table Mountain
Channel 7:	155.100	155.745(R)	Black Mountain

Channel 1: Designation is blue  
 Channel 3: Designation is black  
 Channel 5: Designation is white  
 Channel 7: Designation is red

### Other frequencies used by De Anza Search and Rescue

155.325—(EMS)—Emergency Medical Service—Ch. 1  
 155.175—(EMS)—Emergency Medical Service—Ch. 2  
 154.920—(CLEMARS)—Valleywide Simplex Only!  
 123.100—National Aircraft Search and Rescue (De Anza Callsign is KN4729); (Also C.A.P.)  
 155.160—Search and Rescue (De Anza control callsign is KZR411 or 412)  
 (De Anza mobile unit's callsign is KP3785)

### Ham or radio amateur repeaters sometimes used in emergency search or disaster communications opns.

U.S.A. 147.150—Mt. Laguna  
 146.640—Mt. Laguna  
 Mexico 146.970—Mexico  
 146.910—Mexico

### ELT (Emergency Locating Transmitter) Frequencies — Aircraft

121.500—Civilian Aircraft  
 121.600—Civilian Aircraft (Practice)  
 243.000—Military Aircraft

### Frequencies which are often used by other agencies in association with search and rescue or emergency disaster communications.

#### Aircraft

Mexico 118.200—Mexicali, Baja California Tower.  
 U.S.A. 122.600—Imperial, California Flight Service (F.A.A.)  
 126.200—N.A.F. (Naval Air Facility)—El Centro, California

#### State of California

151.430—Fish and Game Department  
 154.160—Office of Emergency Services (O.E.S.#1)  
 154.220—Office of Emergency Services (O.E.S.#2)  
 153.755—Office of Emergency Services  
 Blue 42.180—California Highway Patrol (Mobiles) (El Centro Office #85)

42.340—California Highway Patrol (Base) (El Centro Office #85)  
 154.905—Highway Patrol Extenders

#### U.S. Government

INS 163.625—U.S. Border Patrol (Yuma Sector)  
 163.725—U.S. Border Patrol (El Centro)  
 163.775—U.S. Border Patrol (Calexico)  
 163.675—U.S. Border Patrol (Aircraft to Ground)  
 BLM 167.00—Bureau of Land Management Rangers  
 166.4875—Bureau of Land Management Rangers  
 166.375—Bureau of Land Management Rangers  
 BLM Mobile 166.675—Rangers (car to car mobile operations)  
 166.265—Rangers (car to car mobile operations)  
 148.150—Civil Air Patrol (ground communications)

### Additional Imperial County Frequencies

#### Fire

154.370—Imperial County (Orange)—West/South/East  
 154.010—Imperial County (Green)—North  
 WZM846 154.430—Imperial County (Blue)—Headquarters  
 154.280—Imperial County (White)—Mutual Aid  
 WRU992 153.890—El Centro Fire (Yellow)—Tactical

#### County Government

KMK359 155.880—Road Department and Health Department

#### Police

KMA790 154.815—El Centro (Ch. 1)/Imperial dispatched by El Centro (ocean units)  
 KMA790 155.250—El Centro (Ch. 2)  
 KMA781 155.010—Brawley  
 KMB263 155.130—Holtville/Calexico (Ch. 1) (KMA826)  
 KMA826 154.725—Calexico (Ch. 2)

#### City Government

KBW825 45.160—Imperial  
 WQN932 154.040—El Centro

#### Mexican Frequencies

148.220—Mexicali Fire Department (Bombaderos)  
 148.000—Mexican Fire Rescue  
 148.720—Mexicali Fire Department  
 148.125—Mexican Red Cross

#### Imperial County/San Diego County American Red Cross

KJT887 461.225—(Ch. 1)  
 KAC6157 462.650—(Ch. 2)

However, the worst was yet to come; the mountain rains (up to 8 inches) were to run down the western slopes and hit the small western county village of Ocotillo. DARU was activated when a woman and four children were stranded in the Painted Gorge area and no one could get to them. A flash flood one quarter of a mile wide and five to eight feet deep washed out Interstate Highway 8 and a railroad bridge west of Ocotillo. Town houses located nearest the wash, which runs through the center of the community, were reduced to rubble in a matter of minutes. The Imperial County Sheriff's Office activated their helicopter, Eagle One, which was able to locate the children along with their mother on high ground and evac-



DARU Communications officer Ben Green radios other members of the team from his fully equipped mobile search and rescue vehicle. (Courtesy Ed Goodell)

uate them safely. DARU established a base station at Ocotillo and members of the unit were sent out to evacuate all of the village's residents to the local fire hall.

Those wishing to listen to search and rescue operations can simply tune in 155.16 which is the national search and rescue frequency. However, the De Anza Search and Rescue Unit does not only use this frequency, but can be heard on the sheriffs' radio channels as well. Sometimes, DARU may use CLEMARS, which is the statewide law enforcement frequency in California (154.920). A more comprehensive list of frequencies that can be used in association with De Anza's search and rescue operations appears within these pages. **PC**

# "INSIDER'S INFORMATION"

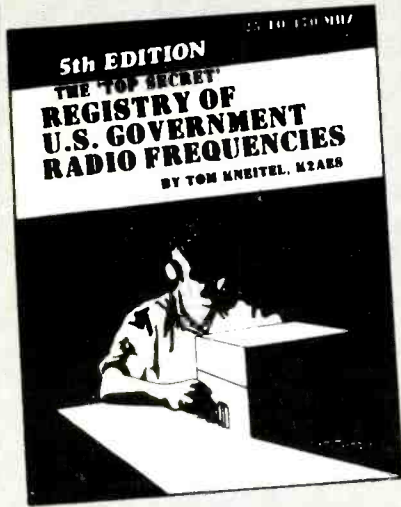

Since 1967, CRB Research has been the world's leading publisher and supplier of unique hobby and professional books and information including:

- Scanner Frequency Guides
- Shortwave Frequency Guides
- Military/Federal Communications
- Broadcast Station Registries
- Undercover Communications
- Survival Communications
- Covert Operations
- Electronic Espionage
- Surveillance
- Monitoring
- Cryptography & Codes
- Bugging
- Wiretapping
- Communications Antennas
- Electronics & Projects
- Authentic Combat Communications Cassettes
- Computer Technology
- & Other Related Topics!

New titles are constantly being added to our exciting catalog. If it's interesting and unusual, we've got it. You'll see! Ask for our latest FREE catalog!

**CRB RESEARCH**  
P.O. Box 56 Commack, NY 11725

CIRCLE 96 ON READER SERVICE CARD

# POP COMM BOOK SHOP

## Guide To RTTY Frequencies 2nd ed.

Details on 5500 RTTY stations/frequencies in two lists. "Real" press schedules, inside information on new RTTY techniques, etc. 192 pages, paperback, \$9.95. Order #G205.

## Radio Handbook, 22nd ed.

by Bill Orr, W6SAI

A state-of-the-art, single-source reference on radio communications and theory for hams, professional ops, techs, and engineers. New coverage includes solid-state devices, Yagis and quads, and H.F. amplifier designs. A hands-on instruction manual, as well. 1168 pages, hardcover, \$39.95. Order #S197.

## The Radio Publications Group—The "Bill Orr Series"

These easy reading classics belong in the library of any active ham. Loaded with practical how-to information, with tables, charts, and formulas arranged for handy reference.

**Beam Antenna Handbook**, 200 pages, paperback, \$7.95. Order #R143.

**Wire Antennas**, 192 pages, paperback, \$7.95. Order #R144.

**Antenna Handbook**, 192 pages, paperback, \$7.95. Order #R145.

**Cubical Quad Antennas**, 112 pages, paperback, \$6.95. Order #R146.

**VHF Handbook**, 336 pages, paperback, \$11.95. Order #R147.

**Interference Handbook**, by W.R. Nelson, 247 pages, paperback, \$9.95. Order #R172.

## World Radio TV Handbook 1984

The world's only complete directory of international broadcasting and TV stations—the established, authoritative guide endorsed by the world's leading broadcasting organizations. A comprehensive country-by-country listing of short-, medium-, and long-wave stations revised and updated to reflect actual conditions. Also includes special features on shortwave receiver test reports and DX clubs and their programmes. 608 pages, paperback, \$17.50. Order #B097.

## World Press Services Frequencies

by Thomas Harrington

A comprehensive manual covering the field of radiotele-type news monitoring—antennas, receivers, terminal units, monitors, and more. Contains 3 master lists of times of transmission, frequencies, plus ITU list of over 50 news services worldwide. 84 pages, paperback, \$8.95. Order #U173.

## The Final Exam

by Dick Bash, KL7IHP

Amateur radio license exam manuals proven highly successful in helping hams pass the FCC tests. Material for the books was obtained by interviewing actual applicants for the exams and collecting and researching the questions they had on the exams.

**General Class**, 123 pages, paperback, \$9.95. Order #B153.

**Advanced Class**, 108 pages, paperback, \$9.95. Order #B154.

**Extra Class**, 108 pages, paperback, \$9.95. Order #B155.

**Novice Class**, 104 pages, paperback, \$9.95. Order #B163.

# POPULAR COMMUNICATIONS BOOK SHOP

76 N. Broadway, Hicksville, NY 11801

QTY.	ORDER #	TITLE	PRICE	TOTAL

Shipping charges \$2.00 per order. Shipping charges waived on orders of \$50.00 or more. Books shipped best way. All orders are processed the day they are received, but please allow 30 days for delivery within North America.

**Book Total**  
**Shipping Charge**  
**Grand Total**

Order Date: \_\_\_\_\_

Name \_\_\_\_\_

Street \_\_\_\_\_

City \_\_\_\_\_ State \_\_\_\_\_ Zip \_\_\_\_\_

Check  MasterCard  VISA

Card No. \_\_\_\_\_ Expires \_\_\_\_\_

X \_\_\_\_\_

Signature required on all charge orders.





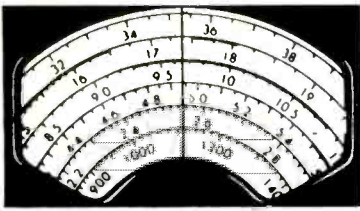

# COMMUNICATIONS CONFIDENTIAL

BY RON RICKETTS, WA5VFA

## YOUR GUIDE TO SHORTWAVE "UTILITY" STATIONS

**L**ong-time contributor George Osier of New York sends us copies of two very nice QSL cards he recently received. The first is from LOL, the Argentine Naval Observatory of Buenos Aires. LOL operates on frequencies of 5, 10, and 15 MHz, sending time and frequency signals similar in format to WWV. Unlike WWV, LOL does not operate continuously but is off the air at intermittent times during the broadcast day. LOL transmits audio tones of 440 and 1000 Hz respectively; time ticks of 5 millisecond duration with a carrier frequency accuracy of two parts in 10 to the 20th power. LOL transmits with an output power of 2000 watts to each of three dipole antennas. Because of the strength of WWV, LOL is difficult to hear and is a nice catch.

George also sent a copy of a recent QSL from BSF, a time and frequency standard located in the People's Republic of China. BSF transmits from Taiwan on 5 and 15 MHz with an output power of 5000 watts. The transmissions consist of alternating five-minute segments that have time ticks on the

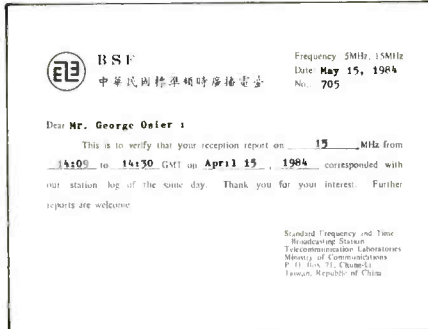

Reader George Osier sent along this QSL from Station BSF in the Republic of China.

second with either no modulation or 1 kHz modulation. BSF welcomes reception reports and will reply with a QSL card. Thank you for sharing your cards with us, George.

Harold Easley of Maryland writes to tell about some curious beacon signals he has noted recently while monitoring numbers station activity on 6802. Harold was monitoring a 4-digit Spanish numbers trans-

mission at 0206 when he noted several CW beacons in the background. Over several evenings of monitoring, he noted the following interesting signals.

Frequency	Time	Signal
6802.0	2305	"C C C C data burst" repeated
6802.5	2245	"P P P P data burst" repeated
6803.0	0206	"D" beacon, very weak
6803.5	0300	"G" beacon came up, weak
6804.0	0000	"O" beacon came up
6805.0	2335	"Z" beacon, off at 2340

Harold has also noted beacon activity below the bottom edge of the MW band.

Frequency	Time	Signal
517.0	0855	"YWA" beacon
523.0	0859	"UOC" beacon
531.0	0903	"NB" beacon
525.0	0909	"HEH" beacon
516.0	0922	"OS" beacon
522.0	2030	"NZVE" beacon, quite strong

All of the above were heard in one eve-

Both sides of George Osier's QSL from station LOL in Argentina.

**CENTENARIO OBSERVATORIO NAVAL**  
1881 - 16 de Agosto - 1981

Gráfico de una hora de transmisión

  
**ARMADA ARGENTINA**  
**OBSERVATORIO NAVAL**  
BUENOS AIRES  
REPUBLICA ARGENTINA

SERVICIO DE FRECUENCIAS PATRONES DE L O L  
Service of Radiofrequency Standards L O L St.

— Q S L —

Señor George F. Osier.

Recibimos su informe sobre la recepción de nuestras señales de frecuencias patrones  
We received your report on the reception of our standard frequency signals  
y hora efectuado el día 10 Apr. 1984. Agradecemos su atención y  
and time received by you on 10 Apr. 1984. We thank you for your courtesy and  
al felicitarlo por su eficiente recepción nos complacemos en saludarle muy atte.  
congratulate you on the efficiency of your reception. Very truly yours.

Buenos Aires, Mayo 23 de 1984.

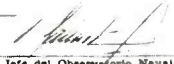
  
Jefe del Observatorio Naval  
Superintendent of the Naval Observatory  
**PASCUAL JAIME PATUEL**  
PERSONAL CIVIL SUPERIOR  
JEFE DPTO. OBSERVATORIO NAVAL

Estación Emisora: LOL, Buenos Aires {  $\phi$ : 34°37'19"S  
Transmitting Station {  $\omega$ : 58°21'18"W

Horas de Emisión: 0800 a 0900, 1100 a 1200, 1400 a 1500, 1700 a 1800 y 2000 a 2100 hora oficial Argentina (Huso 3 horas W)  
2100 hora oficial Argentina (Huso 3 horas W)  
2100 Argentine official time (Time Zone 3 hours W)

Radiofrecuencias Patrones: 5, 10, 15 Mc/s.  
Radiofrequency Standards

Radiofrecuencias Patrones: 1000 y 440 c/s. alternativamente.  
Audiofrequency Standards: 1000 and 440 c/s. alternatively.

Potencia de Antena: 2 Kw. Dipolo trifilar horizontal.  
Power in Antena: 2 Kw. Two poles, triple wire, horizontal.

Intervalos de Modulación: 3 sobre 8 minutos, excepto de 55 a 59 minutos. Intervalo Modulación: 3 on 8 minutes except from 55 to 59 minutes. Intervalo destinado a señal horaria.  
destined to the time signal.

Exactitud de las Frecuencias: Dos partes en 10<sup>20</sup>.  
Precision of the Frequencies: Two parts in 10<sup>20</sup>.

Señal Horaria de Precisión: Durante toda la señal se emite un pulso de 5 milisegundos.  
Signal Time of Precision: During the entire signal a pulse of 5 milliseconds is emitted.

Los intervalos de tiempo son exactos dentro de los 2 microsegundos y las señales horarias tienen un error normal menor que  $\pm 0.01$ .  
The intervals of time are exact within 2 microseconds and the time signals have a normal error of less than  $\pm 0.01$ .

ning. There has been considerable speculation on the source and purpose of these CW beacons, but no satisfactory explanations as of yet. Do any of you readers have any ideas? Thanks to Harold Easley for his interesting letter.

### **The KGB Is Watching You!!!**

Reed Darsey of Alabama passes along some interesting references to numbers stations contained in the book *KGB Today*, *The Hidden Hand*, by John Barron, 1983, by The Readers Digest Association. On page 314, Barron tells how an unnamed spy kept a hairbrush with a hollowed out handle containing a schedule of radio broadcasts, which sent dots and dashes in groups of five. A particularly ironic statement is made on page 320: "... deciphering messages from the center. Often the messages, which took as long as 18 hours to unravel, turned out to be congratulations on May Day ..."

On page 354: "... they described a marvelous new radio that would vastly simplify his work. It automatically recorded burst or 'squirt' messages compressed into a second and transmitted via a satellite. A device within unraveled the burst on the recording; he could listen and decipher at leisure. Never would there be any missed letters or problems with the static."

"Squirt" mode is not new; it was being used successfully at the end of WWII. What is intriguing is the fact that the information could be sent from a satellite overhead. In order to receive a message of any length, the theoretical bandwidth of the transmission would have to be very wide; hence more easily detected. All of this would lead one to believe that the numbers transmissions we hear so often are merely a smokescreen, and that most spy communications occur in more subtle ways. Thanks to Reed Darsey for his informative letter.

### **Musical Numbers???**

Mark Tattenbaum of New York sent us a note telling about hearing a musical interlude on a numbers station. It all began when he was tuning around one evening looking for Radio Reloj, a popular Costa Rican broadcast station. R. Reloj is located on 4832 kHz, but Mark noticed an even stronger station with music and a male announcer on 4822. It was very strong, with a meter reading of 20 dB over S9. The music played from 0450 to 0505, at which time a female announcer began a numbers transmission in Spanish. The number segment continued until 0510, with the station leaving the air at 0515. Mark did not state whether it was 4 or 5 digits. I have personally never heard a Spanish numbers station with a musical interlude. Have any of you readers heard anything like this?

### **DF'ers Unite**

I have received a large number of letters from individuals in every part of the country who have wanted to participate in a concerted direction finding effort. This effort will

not just be at numbers stations; several types of transmissions will be attempted. The purpose for this is twofold; first, the natural curiosity of those who would like to know where all of these numbers are coming from; second, it would be interesting to see the degree of accuracy that could be obtained by a large, dedicated group of individuals. I think that, even considering our primitive techniques, if enough people participate and measure the same station several times, then with the use of mathematical techniques a very accurate location could be produced.

I am sure that there are those of you who might have reservations about something like this. There is nothing to be concerned about. Believe me when I tell you that all of the large entities sponsoring these activities know who each other are. It is only us who are kept in the dark. Once the results of this measurement are calculated, they will be published right here in *POP'COMM* for all to see. If you would care to participate, send an SASE to me in care of this column.

### **Equipment For The Utilities Monitor**

I have received several letters recently asking me what equipment I use for monitoring and what I would recommend for various purposes and pocketbooks. To begin, a listener does not have to spend a small fortune on a receiver to get considerable enjoyment from the hobby. When I began monitoring utilities, my first receiver was a converted ARC-5 command receiver that I bought for seven dollars at a hamfest. It was very limited in tuning range and I had to use earphones because there wasn't enough audio to handle a speaker. But for the price, it couldn't be beat. Back then, surplus equipment was readily available at giveaway prices. It was a tinkerer's dream. Nowadays, except for certain later models, any of the surplus rigs are easily eclipsed (except in the weight category) by the vast selection of commercially available multiband receivers. I can truthfully say that the majority of multiband radios sold today for fifty dollars or so are more than adequate for the casual listener. Note that I said "casual." When one really gets the fever, a room full of super receivers is barely enough.

Your particular interests in listening will govern your selection of equipment. If you are interested in RTTY, you will need a considerably more stable receiver than you would if you were planning on monitoring numbers or foreign broadcast. Sensitivity is not as important as you would think; any modern receiver is as sensitive as you will ever need. Image rejection and stability are more important to me than sensitivity, because sensitivity can be improved with a better antenna system or a preselector ahead of the receiver.

The one feature that is becoming more a standard is the digital display. If you are a serious utilities monitor, correct identification of some stations depends on the accuracy to which you can measure the frequency.



This is one feature that I would be hard pressed to be without. If your intentions are serious, or border on the fanatical, then a digital display for frequency is mandatory.

I am not in the business of selling radio equipment, so I feel that I can make a few general statements without undue bias. Bear in mind that these are the things that suit me, but might be inadvisable for someone else. Though I enjoy using my sophisticated base-station receiver for RTTY, I will say that the majority of my numbers monitoring is done on a portable with an outboard antenna. In fact, I find myself using this rig whenever I travel as well. The whip antenna supplied on a portable does seem somewhat insensitive, but most small receivers are a bit short on dynamic range (that is to say they overload more easily than a more sophisticated rig). For that reason, too much sensitivity will cause cross modulations and overload. I have found that the portable is just about perfect when used in the field with its built-in whip and fine at home with a 10-foot piece of wire across the window sill. Crude sounding, yes—but very effective.

Every situation is different, of course. These are the tools I use, but you might like something else. For those of you who are new to the hobby, or have not yet obtained a receiver, I recommend scanning the advertisers in *POP'COMM* and sending for their literature. If you stay with name-brand equipment, you will seldom regret it. Try to talk with someone who has the type of equipment you wish to purchase and arrange for a hands-on demo if possible. This will be more helpful than a boatload of brochures. Next month, I'll give you some tips on effective antennas for shortwave monitoring.

### **From The Mailbag**

John Berezin of Wisconsin writes to comment on the "almost QSL" to Tom Kneitel



reproduced in the May '84 issue. He points out that the translation of the last paragraph is incorrect and should read as follows: "Special (reception) verification cards for Soviet space rockets are not issued."

The point is that kartochnka-kvitantsiia is Russian for "verification card" or "QSL." This might be of benefit when corresponding with stations in the USSR. John's point is well taken and appreciated.

Phil Crump of Oregon writes about some unusual sounding CW he heard on 4706, 4720, and 4803 kHz. He stated the signals were very wide, the dots had a metallic ring, and the dashes were more like a scratch. The patterns of dots to dashes did not make any normal CW characters either.

In this case, what Phil has probably been hearing is FAX (facsimile) transmissions doing a test sheet. Normal FAX goes through a rotation about once a second, making a scratch-scratch sound—sort of like a bottle on a hand-powered grinding wheel. When the FAX machine is running empty, or has a test sheet with a grid-like pattern on it, the FAX signals sound remarkably like CW.

## Listening Reports

This month's listening reports are some of the best I have ever seen. I would like to thank all of you who have sent them and would like you to keep up the good work. Send your reception reports, comments, and questions to Communications Confidential, Popular Communications, 76 North Broadway, Hicksville, NY 11801. Let's get to them.

**1638:** CW marker with call sign U447; 3 calls in 60 seconds, then off air for four minutes. Heard at 1428. (J. E. Gregory, Australia)

**1642:** A variety of CW beacons operating as above. Calls heard at various times: Z27, E449, SG447. (J. E. Gregory, Australia) Interesting loggings from down under. Thanks, Jim. Could these possibly be navigation beacons from around the Barrier Reef?

**2153:** CW beacon with call sign repeated three times in 60 seconds, then off for four minutes. Heard at 1634. (J. E. Gregory, Australia)

**2630:** "V" marker in CW at 1250, 9MB2, 3, 4 from Penang Naval Radio, Melanesia. (J. E. Gregory, Australia)

**2824:** "K" beacon in CW, repeated every three seconds, at 1519. (J. E. Gregory, Australia)

**4184:** YUR DE YTIF, YUR DE YTAS in CW at 0057. YUR is Rijeka, Yugoslavia. (Don Schimmel, VA)

**4220:** "DE LZW" call tape in CW at 0051. LZW is located in Varna, Bulgaria. (Don Schimmel, VA)

**4221:** "DE GYU QX 4 6" marker in CW at 0053. GYU is located in Gibraltar. (Don Schimmel, VA)

**4268:** CKN, Vancouver Forces Radio, BC, sending a five letter, forty group "73992 Yankee Oscar Tango India Uniform" message from "CZVJ" to "LZBZ" in CW at 0439. (Robert Margolis, IL)

**4282:** English 4-digit numbers stations with female announcer at 0027. (George Osier, NY)

**4525:** Time signals from Y3S, Berlin (Nauen), GDR at 2326. (George Osier, NY)

**4607:** "36FXL" sending 5-digit groups in CW at 0216. (Robert Margolis, IL)

**4625:** VEB2 time signals in USB at 0030. One pulse every two seconds. (George Osier, NY)

**4671:** Female announcer repeating "Victor Lima Bravo 2" in USB at 0004. (George Osier, NY)

**4781:** WGY912, FEMA special facility at Mt. Weather, sending five-letter group, six-group messages in slow CW at 0531. Each message was repeated eight times. (Robert Margolis, IL)

**5135:** Spanish 5-digit numbers station in AM at 0009. The announcer was female and modulation was very poor. (George Osier, NY)

**5223:** 4-digit English numbers station with female announcer in SSB. Was transmitting from 0039 to 0042. (Dennis Kosakowski, MA)

**5238:** Spanish 4-digit numbers station with female announcer in AM at 1100. Transmitting parallel at 6800 with stations reading S9 + 20 dB. (George Osier, NY)

**5315:** 5-digit German numbers station in AM with female announcer at 0010. (Tom Lewandowski, NY)

**5316:** German 5-digit numbers station in 3/2 format in USB at 0011. The announcer was female, with an unfamiliar voice. (George Osier, NY) You don't say in your logging. George, but was it a live transmission? (Editor)

**5332:** Male announcer in LSB at 2337 with "one through niner," followed by "niner through one." Then, "testing for transmitter identification and receiver alignment," repeated until 2348. No ID was ever given. (George Osier, NY) This sounds a lot like the old AT&T test transmissions of several years ago. But AT&T had a female announcer with a real nice voice. (Editor)

**5395:** Spanish-speaking male rapidly giving numbers to another Spanish-speaking male in SSB at 0545. The rapidity of the numbers brought to mind the actor who did the Federal Express commercials on television. (Robert Margolis, IL)

**5439:** Female announcer with phonetic traffic in USB at 2334, various dates. (George Osier, NY)

**5641:** Shannon Aeradio, Ireland, with male announcer giving European aviation weather broadcasts at 0103. (George Osier, NY)

**5642:** Female announcer repeating "Sierra Yankee November 2" on USB at 2331. (George Osier, NY)

**5765:** Voice transmission in English at 0152. "Lovejoy" making contact with "Viper1," "Viper2," "Viper3," and "Viper4." After authentication, "Lovejoy" asked each for location and weather. Transmissions were not scrambled. (Dennis Wheeler, NY)

**5770:** 5-digit German numbers station in AM with female announcer at 0340. (Tom Lewandowski, NY)

**5837:** 5-digit Spanish numbers in 3/2 format given in SSB at 0603 by a woman to a Spanish-speaking man, who then relayed the numbers to another Spanish-speaking man. (Robert Margolis, IL)

**6225:** Spanish 5-digit numbers station with female announcer at 0036. Modulation was very poor. (George Osier, NY) George, sometimes these 5-digit stations sound better when tuned in USB. They frequently transmit on only one sideband, usually the upper. (Editor)

**6683:** Andrews AFB working Air Force One at Newark, NJ Airport in LSB at 1610. (Tom Lewandowski, NY)

**6756:** "TEST TUBE" calling Andrews AFB in SSB at 0156. (Robert Margolis, IL)

**6760:** Five figure groups in CW sent by hand between two unidentified stations at 0329. (Don Schimmel, VA) "VENDOR" giving "skyking" broadcast to SAC bombers aloft and "ADHESIVE" calling "MAILBAG" in SSB at 0459. (Robert Margolis, IL)

**6791:** Female announcer repeating "Charlie India Oscar 2" in USB at 2347. Very heavy interference from RTTY. (George Osier, NY)

**6797:** UASF traffic: "Offset" working "Furcoat" in USB at 0510. (Tom Lewandowski, NY)

**6800:** Female at 0200 in AM with "0-3-3" until 0210. Then "grupo 1-4-2" followed by 4-digit groups in Spanish. This transmission in parallel with 9075. (Thad Adamaszek, OH)

**6840:** Female announcer at 0230 in AM repeating "4447-2041-4704-8797" in Spanish. (Thad Adamaszek, OH) Female in AM with "2106-2674" repeated over and over at 0236. At 0240 pulse for 30 seconds then off the air. (Thad Adamaszek, OH) 5-digit groups in CW at 0030 using A B D N T U V 3 4 and 6. (Robert Margolis, IL) 5-digit numbers transmission in German with female announcer. Signal was very strong, +40 dB over S9 at my location. "Ende" at 0021, then footsteps. (George Osier, NY) Excellent logging George. This has turned out to be a real hot spot the last few months. By monitoring this frequency, you can hear virtually every common type of numbers activity over a period of a few evenings. (Editor)

**6870:** "CAKEBAKE" and "WAR46" working "FILL-MORE" in SSB at 0224. This is the "KILO" frequency of KDM50, FAA net control, located in Hampton, GA. WAR46 is the VIP support facility at Fort Ritchie, MD. (Robert Margolis, IL)

**6963:** 5-digit English numbers station with female announcer in SSB at 0323. Was in a 3/2 format. At 0331, she said "repeat" and "count 248." "End" was at 0352. (Robert Margolis, IL)

**7375:** 5-digit alphanumeric groups in CW at 0223. CW

digits cut. using A, B, D, E, N, T, U, V, 3, 4, and 6. (Robert Margolis, IL)

**7405:** German 5-digit numbers station at 0007 in AM with female announcer. (George Osier, NY)

**7410:** 5-digit CW groups with zero cut at T at 0318. (Robert Margolis, IL)

**7415:** "B4GJ" sending a CQ marker at 0342. (Robert Margolis, IL)

**7439:** "tes de 34QSN" (no "t" on "test") with RTTY RY test at 0400. At 0411, "34QSN" called "33AME" and reported perfect copy ("ZBZ 5") then back to test. 850 shift at 100 wpm. (Robert Margolis, IL) This is a good old AME3 in disguise. (Editor)

**7446:** Female announcer repeating "Kilo Papa Alpha 2" over and over at 0010 in USB. (George Osier, NY)

**7527:** 5-digit Spanish numbers station with female announcer at 0400. (Robert Margolis, IL)

**7530:** 5-digit Spanish numbers station with female announcer at 0300. (Robert Margolis, IL)

**7532:** 5-digit German numbers station with female announcer in SSB. Began at 0330 with the woman saying "Bravo Juliet" four times, rolling the R's in "Bravo." This was followed by an Arabesque musical marker. The phonetic words and musical motif were repeated until 0335, when the woman said "Achtung!" and read the digits in a 3/2 format. "Endlich," German for "final," came at 0345. (Robert Margolis, IL)

**8063:** 5-digit German numbers station with female announcer in USB at 0440. (Tom Lewandowski, NY)

**8419:** 4-digit Spanish numbers station with female announcer at 0515. Some groups were in a 3/1 format or had only 3 digits. (Robert Margolis, IL)

**8441:** 33AME, Madrid Naval Radio, Spain, calling 37UMA in CW at 2120. (Robert Margolis, IL) Though supposedly Spanish in origin, 33AME is just good old AME3 in a thin disguise. I can't really think of a good reason for a Spanish station to be calling Leningrad. can you? (Editor)

**8510:** CW marker, "QX 8 MHZ K" from FFT4, St. Lys Radio, France at 1655. (J. E. Gregory, Australia)

**8598:** ZLO, Irirangi Naval Radio, New Zealand, sending a DE/QX marker in CW at 0717. (Robert Margolis, IL)

**8634:** "Aztec Calendar" and "Shallow Five" working "Open Door" in SSB at 1626. (Robert Margolis, IL)

**8651:** "Apple Barrel" working "Straggler," "Twin Bed," and "Apple Jack" in SSB at 1709. (Robert Margolis, IL)

**8657:** ROM, Tashkent Metro, USSR, sending an ID marker in CW at 0408. (Robert Margolis, IL)

**8686:** CNP, Casablanca Naval Radio, Morocco, sending a CW/QSX marker in CW at approximately 0650. (Robert Margolis, IL)

**8709:** HEC, Berne, Switzerland, sending a QRV marker in CW at 0600. (Robert Margolis, IL)

**8746:** CW marker, "QX 8 MHZ K," from 5AB, Benghazi, Libya at 1521. (J. E. Gregory, Australia)

**8768:** DAJ, Norddeich Marine Radio, West Germany, on SSB at 0545 handling ship-to-shore phone patches. (Robert Margolis, IL)

**9041:** German 5-digit numbers station with female announcer in USB at 2342. (George Osier, NY)

**9055:** 5-digit German numbers station with female announcer at 0300. End of message announced at 0315. (John Stachowicz, NJ)

**9074:** 4-digit Spanish numbers station with female announcer at 0100. Was simulcast on 11532 and 6802. (Robert Margolis, IL) This is an unusual logging. Robert I have only heard a triple frequency transmission once before. (Editor)

**9109:** 5-digit groups in CW sent fairly fast, at 1333. (J. E. Gregory, Australia)

**9124:** Five-letter groups sent in CW at 0710. Used A, D, G, I, M, N, R, T, U, and W as substitutes for numbers. (Robert Margolis, IL)

**9224:** Zero-digit Spanish numbers station with female announcer at 0100. All she did was repeat "cinco cuatro cinco" for ten minutes. No counting from uno to cero, no beeps, no numbers, no nothing. (Robert Margolis, IL) Well, Robert, maybe she lost her voice. Seriously, this little "5-4-5" beacon has popped up in several unlikely places, including 6840 kHz. It might be a signal to tune to an alternate frequency for a special message. (Editor)

**9325:** 5-digit German numbers station with female announcer in SSB at 0203. Transmission was preceded by "ALFA ROMEO" and an Arabesque musical marker given before groups, which were in 3/2 format. (Robert Margolis, IL)

**9326:** German 5-digit number station in USB at 2344 with "Charlie India Oscar 2" audible under it. Both stations had female announcers. (George Osier, NY) Very good logging George. Did it appear to be two separate

stations, or perhaps additional modulation on the same signal? (Editor)

**9231:** Unidentified station sending 5-digit groups with zero cut as T, in CW at 0009. (Robert Margolis, IL)

**9265:** In AM at 0102, double beeps to 0105, female with "gruppen 2-4," then 5-digit groups in German. (Thad Adamaszek, OH) Double beeps to 0105, then "gruppen 3-0" in German followed by 5-digit groups. (Thad Adamaszek, OH)

**9435:** Female in AM with "8-2-5" in English at 0205 followed by "group 1-3-4" at 0210. Then 4-digit groups in English. Note that same format as Spanish 4-digit transmissions were followed. (Thad Adamaszek, OH) Good logging here, Thad. I wonder if the same transmitter site as the Spanish transmissions is being used. Any ideas, anyone? (Editor)

**10002:** W3L, unknown location, with CQ marker in CW at 2148. (Robert Margolis, IL)

**10153:** "ZRLC" calling "9CE" in CW at 1345. Then traffic consisting of variable length groups of digits. Originating station located in Teheran, Iran. (J. E. Gregory, Australia)

**10461:** German 5-digit numbers station with female announcer in USB at 2330. Announcer began with "Sierra Bravo" followed by musical tones. (George Osier, NY)

**10500:** German numbers station, 3/2 format with female announcer in SSB at approximately 0213. (Dennis Kosakowski, MA)

**10726:** CMU967, Santiago Naval Radio, Cuba, sending a message to "WRK" using five-alpha numeric groups in CW at 0738. (Robert Margolis, IL)

**11108:** 5-digit German numbers station in 3/2 format with female announcer in SSB at 0040. (Robert Margolis, IL)

**11109:** German 5-digit numbers station in USB at 0003. This station gave ID of "Papa November" with musical tones, transmitted parallel 5016. (George Osier, NY)

**11176:** Albrook AFB, Canal Zone with traffic to "Teal 14" hurricane tracker and phone patch to "Miami Monitor" in USB at 1515. (Tom Lewandowski, NY)

**11201:** RAF VOLMET broadcast in SSB at 0236 with weather and approach info. (R. Chambers, TX)

**11214:** "SENTRY22/WATCH07" working "RAY-MOND24" at Tinker AFB, OK in SSB at 1825. (Robert Margolis, IL)

**11244:** "Redeemer" with foxtrot message by male announcer in USB at 2358. (George Osier, NY)

**12500:** RTTY Cyrillic telegrams, "Murmansk" and "Radio Murmansk" mentioned frequently. 170 shift, 67 wpm at 2356. (Dallas Williams, CO) This is a very fertile area for those of you equipped with an RTTY reader. A considerable amount of Soviet shipping traffic is passed on 25 kHz either side of this frequency. All traffic is in "third level" Cyrillic shift, which will yield fairly readable copy if you turn on the unshift-on-space feature on your reader. (Editor)

**12502:** "UEFZ" with Cyrillic RTTY traffic and RY test at 0239. Signal was sporadic and would end abruptly mid-message followed by high speed CW, then a new RTTY message would be sent. Traffic was slugged "Wladiwostok." Signal ended at 0245, 170 shift, 67 wpm. (Dallas Williams, CO)

**12763:** German Hydrographic Institute with time pulses from 2355 to 0006 in USB. (George Osier, NY)

**12770:** UAT, Moscow, with ID marker in CW at 0605, followed at 0613 with GKE, Portishead, England sending a DE marker. (Robert Margolis, IL)

**12780:** YUR, Rijeka, Yugoslavia, sending traffic and a VVV/QSX marker in CW at 0426. (Robert Margolis, IL)

**12940:** CW marker, "DE LZW," sending continuously at 1645, LZW is Varna Radio, Bulgaria. (J. E. Gregory, Australia)

**13010:** Armed forces phonetic traffic in SSB at 1359. "X34 this is C38D." (Dennis Kosakowski, MA)

**13031:** "VVV DE FUF" CW marker at 2103. FUF is Fort De France NAVRAD at Martinique. (Don Schimmel, VA)

**13181:** Female announcer using phonetics, repeating the following short message in SSB at 1545. "I repeat, E712IB AD CLTWWHE; Break, Break," etc. (Dennis Kosakowski, MA)

**13215:** Female English announcer transmitting groups of mixed letters and numbers at 2122. Letters phoneticized per NATO phonetic alphabet. (Don Schimmel, VA)

**13248:** "RFNV DE COL" CW traffic, Moscow from Havana at 2032. Both ends of transmission audible. (Don Schimmel, VA)

**13294:** Zimbabwe 124 working Kinshasa Air Radio, Zaire, in SSB at 0215. (Robert Margolis, IL)

**13395:** Unidentified CW transmission consisting of six figure groups, five groups per message with pauses be-

tween each transmission. Heard at 2152 and 2112 on different dates. (Don Schimmel, VA)

**13428:** CW cut numbers traffic at 1250, four figure groups. Transmitter has that "Radio Havana" sound. Characters sent at AU34567DNT. (Don Schimmel, VA)

**13430:** Male announcer in English USB at 2240 calling himself ECHO GOLF. He called SIERRA CHARLIE, UNIFORM OSCAR, ROGER VICTOR, XRAY BRAVO AND XRAY LIMA. Appears to be U.S. Military tactical traffic. (Don Schimmel, VA)

**13437:** Five letter groups in CW at 2349. Probably Soviet as special characters IM, OE, OT, and AA were used. (Don Schimmel, VA)

**14448:** KNY37, GDR Embassy, Washington, DC with VVV/QRA marker in CW at 1550 followed by RTTY, 170/66R with plans to boycott the Olympic Games. (Robert Margolis, IL)

**14480:** Male Spanish voice in USB at 0059. Calls to TIBURON, PRIMO, and MUCHACHO. (Don Schimmel, VA) Judging from content and frequency used, this could be smugglers or paramilitary in Central America. Who said SWLing is dull? (Editor)

**14500:** RTTY weather traffic marked "ESA" at 1704, 850 shift, 67 wpm. Possibly SUC60 (Cairo Aeradio) but Cairo is listed as being 425 shift. (Dallas Williams, CO) There is a possibility that this traffic might originate here as most U.S. weather transmissions use 850 shift. (Editor)

**14643:** Carrier with occasional FSK at 1550. Carrier drifted to 14645, then settled at 14640. At 1555 several RTTY messages sent, labeled "ZAMINI TO ZHAVANY" followed by the date. Messages were identical and in an unknown language. They contained some decimal numbers (13.5, 18.25) and several identifiable words—

"MOSKVE" (Moscow?)—and "15 US DOLL." Between messages CW was sent via FSK. At one point the frustrated operator sent "DAM CW" twice on RTTY. Transmission and carrier ended at 1609. At other times on this frequency 5 number code groups labeled "ZAMINI PRAHA" have been copied via RTTY, 425 shift, 100 wpm. Possibly CME325, Czech Embassy, Havana. (Dallas Williams, CO) An excellent logging! The language is most probably Czechoslovakian, as the word "Praha" is the Czech word for Prague, the capital of the country. And yes, I feel sorry for the operator. Can you imagine having to copy the long Czech words in CW? (Editor)

**14670:** CHU, time and frequency standard, Canada, with time signals. ID on the minute in English and French. (George Osier, NY)

**14894:** "QUAKER" giving radio check to "CYCLONE" in SSB at 1700. (Robert Margolis, IL)

**14997:** In CW, "VVV CQ de RWM." The CW became time pulses at 1710 and exactly copies WWV at 15000 kHz but without the minute announcement. (Dennis Kosakowski, MA) This is RWM, a frequency and time standard emanating from Moscow, USSR. Their copying of the WWV format indicates that they have good taste. (Editor)

**15655:** CW beacon transmitting "U" at 0200. (Robert Margolis, IL)

**15950:** JJD, Tokyo, Japan, sending CW telegrams to

JJD2 at 0701. (J. E. Gregory, Australia)

**16058:** UNUT from the Soviet Union, sending coded letter groups in CW at 2040. (Robert Margolis, IL)

**16137:** CML47 (Radio Corp. of Cuba) "TESTING TI ITT WORLD COM NY" with RTTY RY test at 0221, 425 shift, 67 wpm. (Dallas Williams, CO)

**16380:** English numbers spoken by male with accent. No recognizable format, but broken by directives in an unknown language. Transmitter in SSB at 1806. (Dennis Kosakowski, MA) This type of activity is prevalent in this general area. Probably unidentified maritime (smuggling?) activity. (Editor)

**17018:** EBA, Madrid NAVRAD, Spain, with overdue fishing vessel broadcasting CW at 1952. (Robert Margolis, IL)

**17149:** "AME 4/6/8/12/17/22" testing on RTTY with RY's at 1738, 850 shift, 67 wpm. (Dallas Williams, CO) Here is the phantom again. Normally they are calling UMA7, or a variant of that call. No one is entirely sure of what this station is but some sources indicate it is involved in covert work in the Caribbean. The prefix indicates that the station is Spanish, but no proof of that has been forthcoming. Keep your eyes (ears?) on this one. (Editor)

**17455:** RTTY weather messages from HXX23 (St. Assise, France) at 1733, 425 shift, 67 wpm. (Dallas Williams, CO)

**18236:** CLP7 working CLP1 in CW at 1942. Appears that CLP1 is repeating groups of message previously received. Groups are cut numbers, probably MINFORN Affairs frequency. CLP1 is located in Havana, Cuba. (Don Schimmel, VA)

**18420:** Belize City, Belize, testing RTTY with RY's and "OF ALL THE FISHES IN THE SEA THE MERMAID IS THE ONE FOR ME." Heard at 1745, 425 shift, 67 wpm. (Dallas Williams, CO) Nice to see an RTTY op with a fresh sense of humor. (Editor)

**18510:** Dit in CW every second, sounding like some kind of timing signal, at 1416. (Don Schimmel, VA)

**18620:** Cuban Embassy RTTY traffic—"Circular 538"—directed to numerous African countries at 2325, 425 shift, 67 wpm. (Dallas Williams, CO)

**18795:** JGX, Choshi, Japan, with CW traffic in Kana code to JOF38, Syowa Base, Antarctica at 0922. (J. E. Gregory, Australia)

**20752:** HBC88, International Red Cross Headquarters at Versoix, Switzerland sending French traffic in CW at 1457. (Robert Margolis, IL)

**20942:** (approximate) "30" sending reams of press traffic to "31." Origin of "30" perhaps Zaire, as much traffic carries the prefix of "RAUNDA." This heard at 0909 to 0925. (J. E. Gregory, Australia)

**22068:** Santiago Naval Radio, Chile, with RTTY weather in Spanish at 1805, 850 shift, 67 wpm. (Dallas Williams, CO)

**22207:** RTTY Cyrillic traffic at 1755, off at 1800. "Radio Vela" and "Radio Sewastopol" mentioned, 170 shift, 67 wpm. (Dallas Williams, CO)

**22456:** PWZ33, Brazilian Navy, Rio de Janeiro, Brazil, with Spanish RTTY traffic at 2350, 850 shift, 67 wpm. (Dallas Williams, CO)

PC

# MISSOURI RADIO CENTER

Kenwood CR-201

Portable

KENWOOD

- Covers 150 KHz to 30MHz - AM, SSB, CW plus 88 to 108 MHz - FM

\$89<sup>00</sup>

ICOM

- Keyboard channel selection
- 12 Channel memory
- AC or DC operation

YAESU

CALL FOR SPECIAL SALE PRICES

CALL TOLL FREE 1-800-821-7323

2900 N.W. VIVION RD.  
KANSAS CITY, MISSOURI 64150

CIRCLE 37 ON READER SERVICE CARD



## NEW AND EXCITING TELEPHONE TECHNOLOGY

### **"Adding Range To Your New Cordless"**

**T**he brand new 46 MHz/49 MHz cordless phones are available for immediate purchase. Unlike the older sets that operated on a transponder frequency that required the use of power lines as an antenna, the new 46 MHz/49 MHz sets are independent of the noisy AC circuit.

"Customers will be able to talk further with these new sets," comments a Southern California cordless telephone manufacturer. "The range will be about the same as the older cordless phones, but they are still going to talk further."

Same range but talk further? Sound confusing? Let's take a look and see why the new sets will out-talk their predecessors.

#### **Noisy Reception**

The problem with the older sets in obtaining a maximum range of 600 feet was that the handset could never really hear the base clearly. This was because the AC power lines (used as a transmitting antenna from the base transponder) would also retransmit noise to the tiny handset. Also, the tiny handset had a very inefficient loop-stick antenna for the reception of 1.7 MHz signals off of the power lines. This antenna was directional, and with your hand wrapped around it, no wonder you could only get 100 feet away.

#### **New Sets**

The new 46 MHz/49 MHz cordless telephones use a single telescopic whip on both the base as well as the handset to transmit and receive the 46 MHz/49 MHz signals. Built into the base transponder and the handset is a tiny duplexer circuit. The duplexer allows a single antenna to be used simultaneously for transmitting and receiving.

Let's take a system operating on cordless Channel 10. The base transponder simultaneously transmits 46.97 MHz into the telescopic whip as it (at the same time) receives the handset at 49.97 MHz. The handset simultaneously transmits on 49.97 MHz while (at the same time) receiving 46.97 MHz. All of this takes place off of a single antenna on each apparatus.

The duplexer circuit in each set isolates the transmitted signal from feeding back into the receiver section. The duplexer also allows the receiver to use the same antenna without desensitization. Needless to say, the transmitter and receiver sections in the handset as well as in the base transponder must be electronically isolated and shielded to prevent their own transmitted signal from interfering with their receiver section.



46 MHz/49 MHz long range phones are here.

Under no circumstances should you try and improve this arrangement for added range. The factory has adjusted the duplexer for optimum sensitivity and maximum transmitted power that will generate 10,000 microvolts at 3 meters from the telescopic antenna. Any twittling with the duplexer or the transmitter will ultimately lead to decreased performance from your cordless telephone system—so keep your hands out.

What you CAN do is give your base transponder antenna system a better shot at your distant hand-held set. The easiest way to do this is to simply relocate the base transponder in the attic or near a window that overlooks your distant handset. However, if your base transponder cannot easily be moved, you may wish to consider an outside antenna. This should surely expand your range.

#### **Outside Antennas**

"No one really seems to know whether or not the addition of an outside cordless telephone antenna is absolutely legal with the FCC," comments a telephone distributor in Florida. "However, the customers we sell our external antenna systems to all indicate that it dramatically increases their range."

This makes sense. Since most homes and apartments are covered with stucco that is held on by chicken wire, any signal within the home is dramatically reduced as it passes through the grounded chicken wire. However, going to an external antenna system inside the attic or out on the roof, the signal will propagate further and ultimately lead to longer range.

Cordless telephone manufacturers are hesitant to recommend any external anten-

na system that might be connected to their base station transponder. While they acknowledge that it might increase range, they also concede that, if hooked up improperly, it could diminish the capabilities of the inside duplexer circuit.

"I don't think you get any more range with an external antenna—you get just more clarity," comments David Gawne, an engineer for Dynascan Corporation, manufacturers of the popular Cobra 46 MHz/49 MHz systems. When comparing signal levels, David is undoubtedly correct—but if clarity improves on the receive side of the circuit on the handset, range will increase.

#### **First 46 MHz/ 49 MHz Antenna**

You can either build your own 46 MHz/49 MHz antenna, or purchase one already designed specifically to cover the 3 MHz band spread. One of the first entries is the Everhardt fiberglass 46 MHz/49 MHz antenna, Model No. RM179 (919 S. Main Street, Fort Worth, Texas 76104).

"Several cordless telephone manufacturers have tried our new 46 MHz/49 MHz antenna, and they indicate that it does expand the range to the cordless handsets. The only hesitancy of the manufacturers is whether or not the antennas are 100 percent legal to be used with their cordless telephone equipment. Whether they are or not, our dealers are selling this antenna faster than we can produce them," comments Everhardt President Mike Simmons.

We tested their Model RM179 and found that it is quite broad-banded to cover both transmitting and receiving. Its unique design is only 49 inches high and does not need ground radials. This means you can put it up on your roof and tell your neighbors it's simply a lightning rod.

We tested this antenna with a Fanon Courier 46 MHz/49 MHz set. We simply used alligator clips to attach the coaxial cable feedline to the existing base transponder antenna on the cordless base unit. The center of the coaxial cable goes to an alligator clip that goes to the base of the telescopic whip on the transponder. The braid of the coax goes to another alligator clip that attaches to any metal screw found on the base transponder. We retracted the base transponder telescopic whip fully, and laid it down in its holder. Now the energy will transmit up the coax cable and be radiated and received simultaneously by the external antenna.

Our range increase was dramatic—we went from four houses down the street to

twelve houses down the street—an almost triple increase in range. Whether we just increased the clarity or added range, the external antennas certainly do the trick.

### Build Your Own

You can build your own external antenna as a test to see how much range you might be able to achieve with a commercially available unit. It's an easy afternoon project and requires few tools.

You will be developing a quarter-wavelength ground plane with a center frequency of 47.5 MHz. The ground will consist of a center radiator/receiver quarter-wave element that is 57 inches long. This can be fashioned out of welding rod or even a coat hanger. If you use a coat hanger, be sure and remove the shellac at the base end.

The welding rod or coat hanger vertical element should be soldered into a chassis SO-239 connector available at Radio Shack stores. After it's soldered into place, double-check the dimensions and then place a plastic cap on the tip of the antenna for safety.

Four quarter-wavelength radials, also 57 inches long, protrude downward 45° from the chassis connector, and they too can be made out of hangers or welding rod with a safety ball on the ends. They are soldered into the holes of the SO-239 chassis connector.

Finally, RG8X coaxial cable attaches to the center pin of the radiating element with the braid going to the ground side of the chassis connector. A wood or metal pole will allow you to easily mount this set-up on the roof for testing.

**Warning—Watch for power lines when working with antennas on a roof. You could be killed if your antenna comes in contact with power lines.**

The opposite end of the coaxial cable attaches to your base transponder antenna system—center of the coax to the telescopic antenna, and the braid to the chassis of the cordless phone equipment transponder.

Give it a try; and if it works as well as I think it will, you may wish to invest a few dollars in a commercially available 46 MHz/49 MHz antenna. They will work well in giving you the very last foot in the advertised 600-foot range of cordless telephone set-ups. **PC**

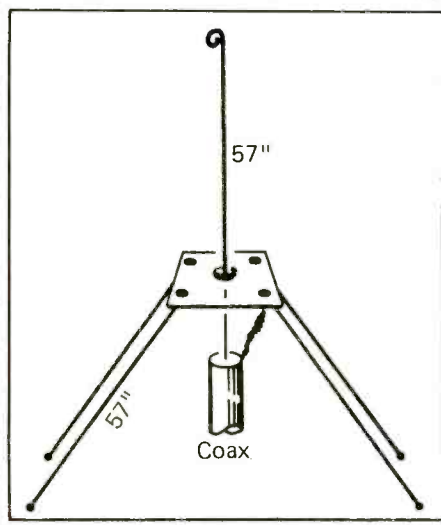

## WE STOCK KENWOOD Bearcat Receivers

BELDEN cable & antenna wire, METZ shortwave antennas, MCKAY DYMEK, AMECO preamplifiers. We stock what we advertise, and much more.  
Call for Quotes: 713-658-0268

**MADISON  
Electronics Supply**  
Call Toll Free  
1-800-231-3057

CIRCLE 21 ON READER SERVICE CARD

## COMPUTER® TRADER MAGAZINE

\*\*\* LIMITED TIME OFFER \*\*\*  
**BAKER'S DOZEN SPECIAL!**  
\$12.00 for 13 Issues

Regular Subscription \$15.00 Year  
Foreign Subscription: \$55.00 (air mail)  
\$35.00 (surface)

Articles on MOST Home Computers, HAM Radio, hardware & software reviews, programs, computer languages and construction, plus much more!!!

Classified Ads for Computer & Ham Radio Equipment

**FREE CLASSIFIED ADS**  
for subscribers

Excellent Display and Classified Ad Rates  
Full National Coverage

**CHET LAMBERT, W4WDR**

1704 Sam Drive • Birmingham, AL 35235  
(205) 854-0271  
Sample Copy \$2.50

CIRCLE 33 ON READER SERVICE CARD

## Telephones & Accessories

**AT LOWEST  
PRICES**

- Cordless Phones
- Memory Phones
- Answerers
- Dialers
- Hardware
- Speaker Phones
- Call Diverters
- Feature Phones

Send for  
Complete Catalog

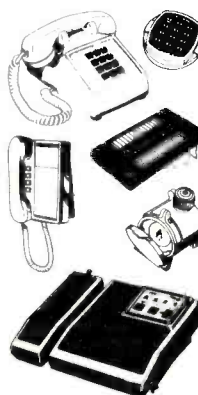

**UNIQUE COMMUNICATIONS, INC.**  
181 E Longview, P.O. Box 5234  
Mansfield, Ohio 44901  
(419) 526-6996

CIRCLE 22 ON READER SERVICE CARD

## CLANDESTINE CONFIDENTIAL

A new and exciting book covering the complete world of clandestine broadcasting yesterday and today — the first book published that covers all areas of this fascinating subject.

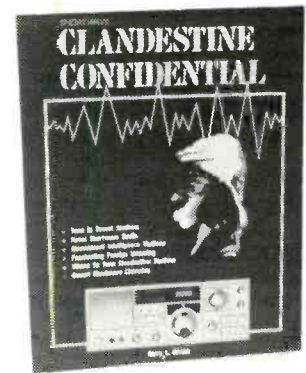

The contents of **CLANDESTINE CONFIDENTIAL** are; **ONLY \$8.95**

- I Clandestine DX'ing — DX'ing and identifying the clandestines.
- II Clandestines Yesterday — full history of the clandestines.
- III Clandestine Today — Listing 30 active countries with their frequencies and full story.
- IV Clandestines Tomorrow — where new clandestines may surface.
- V Clandestine QSLing — Verifying the clandestine stations.
- VI Clandestine station address list — up to date full address list of these many stations.

CLANDESTINE CONFIDENTIAL is exciting reading, covers all countries from Afghanistan to Zimbabwe. A must for the clandestine DX'er as the most up-to-date source of clandestine station address list.

CLANDESTINE CONFIDENTIAL retail price — only \$8.95 plus \$1.75 shipping and handling.

Universal Electronics, Inc., 4555 Groves Road, Suite 3  
Columbus, Ohio 43232 Phone: 614-866-4605

CIRCLE 58 ON READER SERVICE CARD

## MARTIN TOWERS

See the difference -  
the way it looks

- Glistens in Sun - shines in moonlight
- Exceptionable beauty and durability; enhances one's home or business
- Thoughtful engineering - all bolted - no welds to break - strongest aluminum tower made
- Easy to transport, export, store, install, repair
- Hazer accessory raises and lowers equipment and brings things down to ground level

Others will see the difference in your Martin Tower and envy the investment value. By adding the Hazer, tower climbing is needless. The HAZER brings equipment down to ground level keeping it in upright position for maintenance, tuning, calibration. Flexible use with wide variety of antennas, lighting, meteorologic or other scientific packages. Find out why the biggest difference in Martin Towers is the way it looks.

Send self-addressed stamped envelope today for information.

**Glen Martin  
Engineering, Inc.**  
Box P253, Boonville, Mo. 65233  
816-882-2734

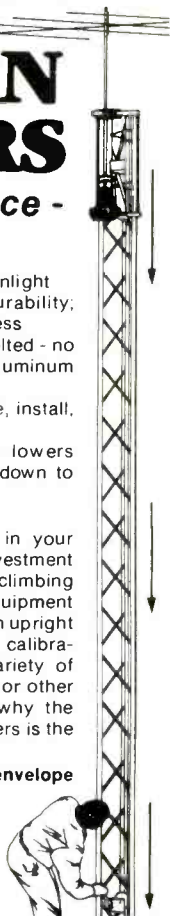

CIRCLE 66 ON READER SERVICE CARD



# WASHINGTON PULSE

## FCC ACTIONS AFFECTING COMMUNICATIONS

### **Unlicensed Radio Operator Faces Injunction**

Joseph P. Russoniello, U.S. Attorney for the Northern District of California, has submitted a complaint for recovery of a \$2,000 penalty and for preliminary and injunctive relief to stop further unlicensed amateur radio operations by Gary W. Kerr of Los Gatos, California.

This action follows numerous attempts by the FCC's San Francisco office to collect the \$2,000 fine which was issued April 13, 1983, following the denial of renewal of Kerr's amateur license (WA6JYI) caused by his disruptive and deliberate interference to 2-meter repeater operations in the San Francisco area.

The above action taken against amateur radio operators has not been a typical response in a service which has for years prided itself as "self-regulatory." However, present problems with 2-meter repeater operators have given the Commission serious concerns for the future of amateur radio requiring firm enforcement action to halt the degenerative trend.

### **New Experimental Stations**

The FCC took the following actions:

**KE2XNT, Texas A&M University, College Station, Texas.** Station to operate on 401.7130 MHz to test and develop phase of a project to adopt a HANDAR/GOES system for use on an instrumented oceanographic buoy.

**KE2XNV, Texas A&M University, Within the Gulf of Maine.** Station to operate on 401.7130 MHz to obtain better description and understanding of the oceanic circulation in the Gulf of Maine via GOES Satellite.

**KE2XNW, Alberta Government, Waterford Ranger Station, Montana.** Station to operate on 401.7595 MHz to transmit hydro-meteorological data to weather satellite.

**KM2XDE, American Electronic Laboratories, Inc., Montgomeryville, Pennsylvania.** Reinstated experimental operation on 20.015, 30, 50, 75.5 MHz for testing of VHF antenna under U.S. Govt. contract.

**KO2XBU, Antennas For Communications, Inc., Ocala, Florida.** Station to operate on various discrete frequencies between 3710 and 11685 MHz to test and develop high gain, low side lobe antennas for the common carrier service.

**KO2XBV, The Boeing Company, Seattle, Washington.** Station to operate on 34.4-35.2 GHz band for radar research.

**KO2XFG, University Of Delaware, Lewes, Delaware.** Station to operate on various discrete frequencies between 3614.4 and 22702.8 kHz for communications necessary under U.S. Govt. contract.

**KO2XFI, RCA Corporation, Waterford Works, New Jersey.** Station to operate on

150-180 kHz to develop techniques equipment operational and engineering data useful to existing or proposed services.

**KO2XFJ, Westinghouse Communication Services, Inc., Linthicum, Maryland.** Station to operate on 9700-9900 MHz band and 9375 MHz to demonstrate modified radar as required by U.S. Government contract.

**KO2XFK, TCOM Corporation, Balloonborne Elizabeth City, North Carolina.** Station to operate on 9700-9900 MHz band and 9375 MHz to demonstrate a radar as required by U.S. Govt. contract.

**KO2XFM, Vitro Services, Ft. Walton Beach, Florida.** Station to operate on 5400-5900 MHz band to develop radar for export to Florida.

**KO2XFN, Vitro Services, Ft. Walton Beach, Florida.** Station to operate on 8500-9600 MHz band to develop radar as required by U.S. Govt. contract.

**KO2XFO, Northrup Radio Services, Inc., Hawthorne, California.** Station to operate on 9700-9900 MHz band to evaluate radar as required by U.S. Govt. contract.

**KO2XFS, Northrup Radio Services, Inc., Hawthorne, California.** Station to operate on 9700-9900 MHz to evaluate radar as required by U.S. Govt. Contract.

**KO2XFX, Gen. Electric Radio Services Corp., Florence, South Carolina.** Station to operate on 861.2625, 862.2625, 865.2625 MHz to determine intermodulation problems either cable or antenna related to installation problems by setting up a data base and standard system which can simulate customer problems and provide opportunity of solution of same.

**KO2XFY, The Stolle Corporation, Sidney, Ohio.** Station to operate on 1850-2200; 3700-4200; 5925-6425; 10500-14500; 17000-18000 MHz for communications essential to research project.

### **Private Radio Rules Streamlined, Updated**

As part of its ongoing effort to review the rules governing various services and eliminate or modify those which are outdated or unnecessary, the Commission has amended the rules of practice and procedure in the Private Radio Services. The changes involve the procedural rules governing the processing of applications and stylistic and editorial changes.

With regard to application processing, the Commission amended appropriate rule provisions to change the current 60-day consolidation period to 30 days, so it would run concurrently with the statutorily mandated 30-day public notice period for the filing of applications.

The stylistic and editorial amendments modify the period within which to amend

applications, update licensing categories, delete outdated references, and clarify various rule parts.

### **Standardizing Digitized Terrain For Determining Antenna Heights Proposed**

The Commission proposed a method of unifying its acceptance of computer-generated antenna heights above average terrain (HAAT). A public notice was also issued specifying interim procedures to be followed until new rules are adopted. It proposed specifying not one source of data but use of a particular format only.

The FCC said it believed the "30 second" file, which typically contains 16 discrete elevation points in an 8 mile segment, was adequate for antenna height calculations when interpolations to produce 50 points are made.

The 30 second point format appeared to be the most available and convenient. Due to variations among sources, however, the FCC proposed allowing use of digitized data in generating HAAT as an option only. The manual method using topographic maps would continue to be the standard in cases of dispute.

Comments on how well computer-generated HAATs "track" the standard method were requested. It said it expected the minor decrease in accuracy when elevations are averaged to be greatly offset by the convenience in processing. It did not propose, however, to allow the use of digitized data for individual elevations such as antenna height above sea level.

Also asked for were comments on whether any one source of digitized terrain data was clearly the best in terms of accuracy, availability, cost, etc. and, if so, should this be a recommended source.

The Commission also asked for comments on whether the accuracy of the overall HAAT calculation might be greatly improved if 50 points on more radials were used.

### **Computer-Generated Terrain Data For Determining Antenna Height Above Average Terrain**

*(Interim Procedure Per General Docket 84-705)*

Until the Commission decides the issues pertaining to the use of computer-generated topographic data, the following will be in effect for Sections 22.115(c)(2), 73.313, 73.684, 81.805, and 90.309(a)(4).

**Computer-generated Terrain Data.** Applicants will be allowed to use any data file with equal or greater accuracy as the 30-second, point file of the National Geophysical

Data Center (formally the National Geophysical and Solar-Terrestrial Data Center). When submitting their applications, applicants should indicate the file used. Topographic maps, however, will be the standard in cases of questioned accuracy.

**Linear Interpolation.** Where the data must be processed for intermediate points along each radial, the applicant will use linear interpolation techniques. In the Commission's program for calculating the average terrain, the linear interpolation is performed as follows:

Select the four 30-second elevation data points (A,B,C,D) around the intermediate data point (G). Interpolate linearly on lines AB and CD to determine the elevation at points E and F, respectively. Then interpolate linearly on line EF to determine the elevation at the intermediate point G. This interpolation would be conducted for each intermediate point on the radial to determine the average elevation for that radial.

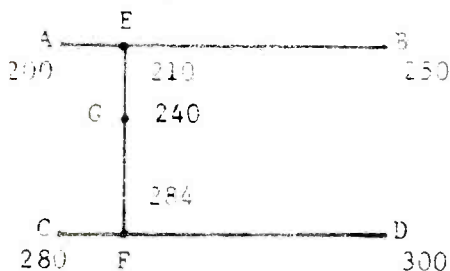

## FCC Field Offices To Discontinue Amateur Radio Operator Examinations

The Commission adopted rules which authorize administration of amateur radio operator license examinations by amateur volunteers. Volunteers are now organized in all 13 regions and are offering examinations. Beginning January 1, 1985, the Commission will no longer offer amateur radio operator license examinations at its field offices nor at cities away from field office locations where examinations were formerly offered at irregular times. Persons wishing to be examined to obtain an amateur radio operator license should contact one of the authorized Volunteer Examination Coordinators (VEC). A current list of authorized VECs is available at all FCC field offices and at FCC headquarters. The FCC will continue to offer examinations as scheduled through the remainder of calendar year 1984.

## Amateur Radio Volunteers FOB Auxiliary

The Field Operations Bureau (FOB), Federal Communications Commission, and the Communications Department, American Radio Relay League, Inc., have agreed to develop and implement an amateur auxiliary to the FOB.

This is the second of two major initiatives by the FCC to improve services and administration of the Amateur Radio Service, made possible by Congressional enactment of Public Law 97-259 (47 U.S.C. 154(f)).

The first step was taken by the Commission's Private Radio Bureau, when it created

volunteer examiner coordinators (VECs) to conduct amateur operator license examinations, which were previously administered by FOB's field staff.

Now FOB, in cooperation with ARRL, is preparing to organize a cadre of volunteers trained to independently handle many of the amateur radio related requests for assistance received by the field facilities. Among other things, the volunteers will devise and implement means to foster wider knowledge of the rules, conduct maintenance monitoring of the amateur frequencies, develop solutions to problems arising from the operation of these radio stations, and undertake other projects identified as the need arises.

As with volunteer examiners, organizations which are of a national or regional scale are necessary for accomplishing the intent of the legislation. Indeed FOB's burden in daily dealing with hundreds of individual volunteers would become quite heavy. The organizations can alleviate this workload, seek consistency in processes and results, train and qualify volunteers and perform other administrative tasks essential to the program. In this manner the budgetary relief for FOB, as intended by Congress, can also be achieved.

We expect this new program to begin in September 1984. General information, points of contact, and other data will be distributed by media which serve the interests of amateur radio. Individuals interested in volunteering their time may contact: Mr. John Lindholm, Communications Manager, The American Radio Relay League, Inc., Administrative Headquarters, Newington, CT 06111, (203) 666-1541.

Organizations which qualify for the program may contact: Mr. W. Elliott Ours, Federal Communications Commission, Field Operations Bureau, 1919 M Street, N.W., Room 744, Washington, D.C. 20554, (202) 632-7090.

## FCC Grants Partial Reconsideration Of Action Allowing Use Of Volunteers To Prepare And Administer Amateur Operator Exams

The FCC granted partial reconsideration of its October 6, 1983, action authorizing the use of volunteers to prepare and administer operator examinations in the Amateur Radio Service.

Capitol Hill Amateur Radio Society (CHARS) sought reconsideration of the requirement that the FCC design the examinations, as well as of certain editorial changes. David B. Popkin asked for clarification of examination identifier codes and reconsideration of the identifier code rules assigning each Volunteer-Examiner Coordinator (VEC) a single, nationally unique identifier for all testing sessions each year. Popkin also sought inclusion of "one continuous minute" for telegraphy exams.

The Commission said it would grant CHAR'S request by eliminating the requirement that the FCC design written examina-

tion elements 3, 4(A), and 4(B). However, rather than immediately permitting volunteer examiners to design amateur operator exams above Novice Class, a two-year transition period during which only VECs would design the examinations would best facilitate delegation of this function.

Turning to Popkin's first request, the Commission noted that the purpose of identifying suffixes is to assure that an amateur operator is not inadvertently made the object of FCC enforcement action when operating legitimately under temporary authority pending receipt of an upgraded license. However, this objective can be achieved by designating four discreet temporary identifiers to be appended as a suffix to a licensee's old call sign for each class of operator license to which an amateur may be upgraded; KT for Technician Class, AG for General Class, AA for Advanced Class, and AE for Amateur Extra Class.

As for reinstatement of a requirement to demonstrate an ability to send or receive telegraphy for one continuous minute at the prescribed speed in order to pass a telegraphy examination, the Commission denied this part of Popkin's request, noting there are several alternatives for proving competency in sending and receiving Morse Code, including message content examinations.

## FCC Amends Rules To Provide For Reimbursement Of Costs For Volunteer-Administered Amateur Radio Exams

The Commission amended Part 97 of its rules to implement Public Law 98-214, approved December 8, 1983, which amended the Communications Act to provide for the reimbursement of out-of-pocket expenses incurred by volunteer examiners (VEs) or volunteer examiner coordinators (VECs) in connection with the preparation, processing, or administration of examinations for amateur station operator licenses above the Novice class.

Specifically, the rules provide that:

- The total allowable cost to be reimbursed per examinee may not exceed \$4.00, which will be adjusted each January for changes in the Department of Labor Consumer Price Index;
- The amount of reimbursement from any examinee for any one examination at a particular session regardless of the number of examination elements taken must not exceed the published maximum;
- VEs or VECs maintain records of the out-of-pocket expenses and reimbursements and certify to the FCC annually that all reimbursed expenses were necessarily and prudently incurred; and
- The VEs and VECs make arrangements among themselves for collection and distribution of the reimbursements.

Action by the Commission July 12, 1984, by Report and Order (FCC 84-322). Commissioners Fowler (Chairman), Quello, Dawson, and Patrick.

PC



# SCANNER SCENE

BY CHUCK GYSI, N2DUP

## MONITORING THE 30 TO 900 MHz "ACTION" BANDS

**A**fter all kinds of hype, they're finally here. The Regency HX1000 hand-held programmable scanner has hit the market. And without wasting any time, I jumped on the bandwagon and bought one of the first units to hit the store shelves. Without question, I am thoroughly impressed by the unit.

The HX1000 has a lot going for it—excellent sensitivity, excellent audio output, easy programming, an adequate 30 channels, and even out-of-band programming.

Frequency entry with the HX1000 is similar to the MX3000 and other recent Regency models. Other functions apparently aren't as easy to operate in accordance with the owner's manual, as several users have turned to me for advice for things such as how to set the clock or how to change the scan speed.

One of the first things I checked with the unit was its ability to program out of band, particularly the ham bands and federal government bands. I was more than pleased to find that the unit can cover approximately 26-66 MHz on low band, 116-196 MHz on high band, and 305-544 MHz on UHF. On low band, you'll be able to tune in the 10-meter ham band from 28-30 MHz and the 6-meter ham band from 50-54 MHz. On high band, believe it or not, you can tune in aircraft, but keep in mind you'll be listening to AM transmissions on an FM receiver. Thus it will seem distorted, but understandable. Also on high band, you can tune in the 138-144 MHz military land mobile band. On UHF, you might be able to snag military aircraft in the 300 MHz band and should be able to monitor federal government stations in the 406-420 MHz band. If you try to program the HX1000 out of these specified ranges, it will read "Error" in the readout, which is liquid crystal display. A lamp illuminates the readout window for nighttime monitoring and automatically shuts off in 20 seconds to save battery consumption.

The hand-held's sensitivity is excellent for a portable scanner— $0.5 \mu\text{V}$  on low and high band and  $0.7 \mu\text{V}$  on UHF (12 dB Sinad, at tune-up). In other terms, the reception range of the HX1000 is excellent. High-band reception probably is best with the unit; with the scanner sitting on the driver's side door in my car, I can easily hear base stations 50 miles and farther away. I've even heard mobiles more than 30 miles away (direct, not through repeaters). I can't wait to try hooking up the HX1000 to a mobile antenna, but then again I've only had it for a total of five days as of this writing. Low band reception is good, but probably could be better; this always seems to be a problem with scanners. On UHF, reception is always tricky because of the nature of UHF signals to bounce around. The signal could be full quieting in

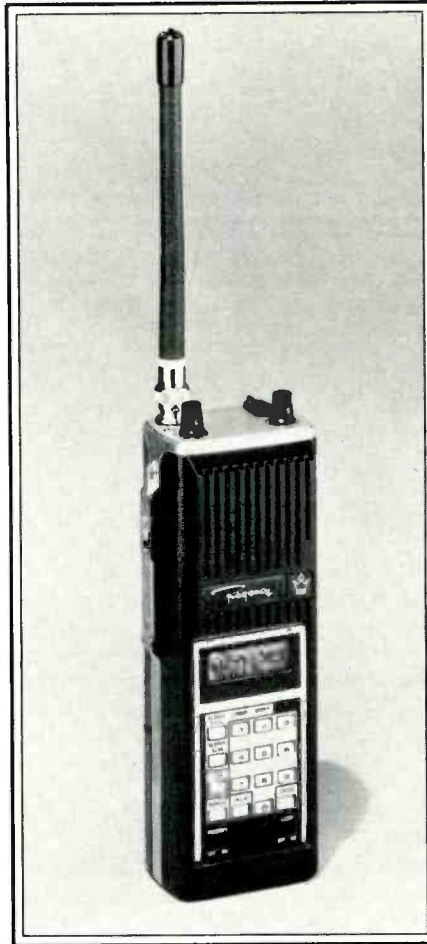

*The Regency HX1000 is a versatile programmable hand-held scanner.*

one position, but almost impossible to receive just inches away in another position.

I have found a reception trick, however. First of all, don't bother to put the plastic cover supplied with the scanner on the radio; the radio looks more like a professional hand-held two-way radio without the cover. The reason I say don't use the cover is because the radio's chassis extends around the side of the unit on a  $\frac{3}{8}$ -inch aluminum strip. The HX1000 is a hand-held: hold it. If you hold it in the palm of your left hand so that your thumb rests in front of the clock switch and your four fingers touch the chassis strip on the scanner's right side, you'll notice reception is best. And as I said before, you may have to move around to hear those weak UHF signals.

The HX1000's audio output, at .2 watts, is more than adequate and performs quite well in noisy environments. You shouldn't have any problems hearing messages either carried on your belt or in the car. Even with several two-way radios chattering and the stereo blaring away, I still have no problem

hearing the HX1000 over all the noise.

Those who have found themselves limited in the past to 4 to 10 channels in a crystal hand-held scanner or even 16 channels in a programmable hand-held will delight in the 30 channels offered in the Regency HX1000. Even though I live in a rural area, I quickly filled up the 30 channels with frequencies of importance. The 30 channels also should be quite adequate for most urban monitors. You can lock out channels that are not of interest simply by pushing the channel number of the undesired channel while it is scanning. To resume monitoring of a deleted channel, simply push in the channel number again while the radio is scanning. Like most scanners, the radio also is capable of searching between two frequencies for channels in use. On VHF, the search increments are 5 kHz and on UHF, the increment is 12.5 kHz, which is good for the 450 and 455 MHz remote broadcast frequencies and the new split frequency channels for low-power use between routine UHF frequencies.

The HX1000 is equipped with a clock, and a switch on the battery can help save battery life whether or not you use this function. If you have no need for the clock to stay on time while the scanner is turned off, a switch inside the battery compartment will turn off the function. With the switch in the off position, the clock will lose time when the radio is turned off. If you wear a watch, why waste the battery life.

The ni-cad battery supplied with the unit can fully charge in about 10 hours with the supplied charger. When the battery is getting low, the word "BAT" appears above the frequency display (the owner's manual does not mention this) and I've found my unit will read "Error" while scanning over UHF frequencies I have programmed in the radio. Eventually, the LCD display will blank out and will lock the receiver on one channel. I really suggest you don't let the battery get that low.

When first turning on the unit each time, the HX1000 is locked on channel 01. You have to hit scan each time you turn it on; it would be better if the scanner automatically scanned on initial power up like the other mobile models. If you don't want to hit the manual button each time to view each of the programmed channels (the beep can become annoying each time the button is pushed), simply keep the manual button depressed and the unit will slowly step through each channel. On search, if the scanner stops either just short of an active frequency or just past the frequency and the reception is distorted because it is off frequency, an up or down switch can be depressed to zero in on the frequency. This is a nice feature. The

unit also has two scan speeds: 16 channels per second and a slower eight channels per second. A priority channel also can be programmed in to channel 01.

If you have programming problems, such as the display showing ancient hieroglyphics, there is a CPU reset switch that can be activated in the battery compartment by pushing the clock-battery switch all the way over to the left. Doing this wipes out the unit's memory, however, so it wouldn't be a bad idea to write down all of the frequencies you program in after loading the 30 channels. I learned the hard way. After letting the battery run down all the way, I plugged in the charger and after a few minutes, tried turning on the unit. Sorry, but the hieroglyphics appeared in the window and I resorted to CPU reset.

A lock switch on the side of the unit locks out the keyboard buttons so you don't accidentally knock the switches while the radio is being carried.

A few minor suggestions for Regency: The earphone plug cover does not sit squarely in the jack and constantly pops out of everybody else's HX1000 that I know of, too. I'm waiting to lose my plug cover for the charger jack; a built in tab similar to the ear-plug jack cover would be good here. And since the unit operates in the aircraft band, why not add an AM receiver to the HX1000? Also, because of the number of channels in the unit, it would be nice if you could automatically punch in a channel number without stepping through all the

channels to get to the desired channel. Several people have said that a mobile charger would be good to have and I agree.

One other good thing that many monitors may be delighted to know is that the HX1000 is equipped with a BNC connector for the antenna. The BNC connector is much more efficient and easier to adapt other connectors to than the standard Motorola-type plug used on scanners until now. Professional communications standards finally are coming to scanner radios. (Now if only some manufacturer would add a CTCSS option to a scanner!)

The HX1000 is bound to become popular with public safety users and particularly news media folks. News photographers are buying them as fast as they can make them.

If you have bought a Regency HX1000, we'd be interested in hearing your comments at POP'COMM. Also, if you have comments about any other scanners, we'd also be interested in hearing them. What kind of features would you like to see manufacturers add to scanners? What scanners do you consider better than others? If we get enough comments on scanner radios in general and specific comments about certain models, we'll publish them in an upcoming column. We'd also like pictures of your monitoring station or mobile setup. Have any interesting frequencies to pass along? We'd like to hear from you. Write: Chuck Gysi, N2DUP, Scanner Scene, Popular Communications, 76 North Broadway, Hicksville, NY 11801.

**ATTACH LABEL HERE**

**SUBSCRIBER SERVICE**

**CHANGE OF ADDRESS**

Planning to move? Please let us know six weeks in advance so you won't miss a single issue of POPULAR COMMUNICATIONS

Attach old label and print new address in space provided. Also include your mailing label whenever you write concerning your subscription to insure prompt service on your inquiry

**PLEASE PRINT**

NEW ADDRESS HERE

NAME \_\_\_\_\_

ADDRESS \_\_\_\_\_

CITY \_\_\_\_\_ STATE \_\_\_\_\_

DATE \_\_\_\_\_ ZIP \_\_\_\_\_

POPULAR COMMUNICATIONS  
76 N. Broadway,  
Hicksville, NY 11801

## Now Hear What You've Been Missing - At A Price Pleasing To Your Ears!



	MX3000 Scanner.....	\$179.95	
	Z10 Scanner.....	\$139.00	
	R-106 Scanner. <b>CLOSEOUT!</b>	<b>\$80.98</b>	
	C403 Scanner.....	\$54.95	
<b>HX650</b>	HX650 Scanner.....	\$72.50	<b>MX3000</b>



Model HC-200 Command Call..... **\$34.95 Each**

Radar Detectors

Model RD-3000..... **\$99.95**

Model RD-4000..... **\$137.95**



Model 19X..... **\$42.95**

Model 21 LTD..... **\$64.00**

Model 25 LTD..... **\$79.95**

Model 29 LTD..... **\$106.95**

**We Also Carry MAXON Electronics!**  
Send for Our Complete Electronics Catalog

**SPARTAN SUPPLY CO., INC.**

P.O. Box 310 Hixson, TN 37343

**CALL TOLL FREE 1-800-251-3904**

We accept VISA, MasterCard, C.O.D., or pre-paid orders (cashiers or certified checks; personal checks held for clearance). Add \$3.25 service charge to each order. Include sufficient shipping; any overage will be refunded. All orders shipped UPS unless otherwise requested. Spartan Supply Company is not responsible for typographical errors. TN Residents call (615) 899-5742



## A SCANNER ANTENNA FOR THE "PROS"!!!

**MODEL SC-3000**

Butternut's patented "Trombone" phasing sections increase capture area and let you pull in the weak signals that aren't even there on conventional scanner antennas.

Covers 30 to 512 MHz

Gain: low range—unity  
VHF—up to 3 decibels  
UHF—up to 7 decibels

High-quality aluminum alloy and stainless steel hardware used throughout.

Wind survival: 100 + m.p.h.  
Height: 11 Feet  
Suggested Retail Price \$65.00

Dealer Inquiries Invited



**Butternut Electronics Co.**  
405 E. Market Street • Lockhart, Texas 78644



# LISTENING POST

BY GERRY L. DEXTER

## WHAT'S HAPPENING: INTERNATIONAL SHORTWAVE BROADCASTING BANDS

A short time ago we bid farewell to Clayton Howard, longtime host of HCJB's DX Party Line program. This month we welcome his successor, John Beck. John comes from Wood River, Illinois (near St. Louis) and holds a BS degree from Manhattan Christian College, where he majored in Biblical studies. He also has a transferred major in Radio-TV Management and Production from Kansas State University and an MA from Central Missouri State University in Mass Communications. He has managed KOBC-FM in Joplin, Missouri, which is associated with the Ozark Bible College. Later he managed KCMW-FM at Central Missouri State.

John says he has been a radio nut for as far back as he can remember and built a Heathkit shortwave set while in junior high. He holds amateur radio call WBØRXL and has been active in the Air Force MARS program as AFB3FG. He hopes to be on the air from Ecuador on the ham bands soon.

His listening covers all aspects—shortwave broadcast, medium wave, utilities, CW, and RTTY. He remembers listening to Radio Prague during the Russian invasion of Czechoslovakia in 1968.

John began "deputation activities" with HCJB in 1982 and did his first DX Party Line show in mid-June of this year. While John notes that he may make some minor changes in production techniques or cover some areas that haven't had much emphasis before, there are no major changes planned for the DX Party Line format, although he will be using some material from POP' COMM's pages in his programs. He notes that comments and suggestions are welcome and should be directed to his attention at HCJB, Casilla 691, Quito, Ecuador. (DX Party Line is aired Tuesdays and Sundays GMT at 0230.) We look forward to listening to John Beck on the DX Party Line for many years to come!

The Listening Post is still looking for information about the various local and regional listening and DX clubs around the country and we hope to eventually compile a list of these groups so listeners will know whether there are any other DXers nearby. If you are a member or help run such a local or regional club, we'd appreciate receiving a sample bulletin along with membership information and costs. Hopefully it will mean some new members for all the local groups down the line. Just mail the information to my attention at POP'COMM headquarters.

Speaking of clubs, the SPEEDX group has a new address. After many years of headquartering in California, they've moved to Arizona—specifically to 7738 East Hampton Street, Tucson, Arizona 85715. A new publisher and a new business manager have also taken over those club positions.



*J.M. Janicke of Butler, NJ has been a shortwave listener since 1936! Here he is in his ham shack. He holds call letters K2JFJ.*



*Here's James Morgan of Bangor, Maine with his nice line-up of listening equipment.*

The popular broadcasts of Radio Earth over WRNO have some interesting and useful additions to their features line-up of late. On Tuesdays, Radio Earth is carrying a re-broadcast of "Sweden Calling DXers." Radio Earth does the same thing for "Swiss Shortwave Merry-go-Round" on Saturdays. So, listeners now have the opportunity to hear these two fine DX shows more clearly, albeit a little bit delayed. Another new Radio Earth feature is a segment of the "Dialogue" feature called "HamNotes," which is offered up by Duke Alexander, whom you may have heard doing the North American DX Report on Radio RSA's "DX Corner." A special thanks to Keith M. Anderson of Houston, Texas for the latter piece of information.

The long-awaited new 50 kilowatt transmitter the Chinese supplied and installed for Radio Tanzania-Zanzibar is apparently now on the air. Recent news indicates that it is in use at 0600 on 11.735. You might want to check that out, especially if you haven't yet logged this one.

There are a few other bits and pieces of news: India is putting a new 100 kilowatt shortwave transmitter on the air from Malad, a suburb of Bombay. The new facility will replace the old Bombay transmitters. Three 50-kilowatt units are coming on the air or may already be broadcasting from Botswana. Check 0300 on 4.848 (sometimes variable) and 7.295 or 7.255 at 0400. We've no idea yet where the others may show up. Indonesia's new 11.700 frequency, heard in the U.S. around 1300 to 1600,

may be from the new transmitter at Cimanggis. In Ecuador an old one has come back, La Voz del Rio Tarqui at Cuenca on local evenings on slightly variable 3.285. Belize is also on the frequency. Sudan has returned to shortwave after an absence. Try at 0400 sign on on variable 6.159. You might also catch them just before sign off at 2200. The 5.039 spot seems to be an on-again, off-again affair.

This month's mail includes a letter and shack photo from Bob Syphax of Long Beach, California who notes that a Radio Shack DX-200 and Sony models 2001 and ICR4800 are not pictured. Bob says the Pacific is his favorite DX target. Thanks for the additional pictures you sent Bob. We'll make eventual use of them.

James E. Morgan of Bangor, Maine sends in a shack photo too, plus a QSL from Radio Japan via the Africa Number One transmitter in Gabon. James wants some information about Arthur Cushen's book *The World In My Ears*. That book is available for \$7.95 plus 50 cents postage from our friends at Gilfer Associates, P.O. Box 239, Park Ridge, NJ 07656.

Another listener from the "Maine-line" is David Demsey of Augusta who is getting back into the hobby after a time away. He had 15 years of DXing under his belt earlier. Dave wonders about a mystery station in Spanish on 10.040. That's La Voz de Cuba Independiente y Democratica's Radio Camillo Cienfuegos service Dave and, yes, it certainly is a clandestine and a very powerful one. The station does confirm correct reception reports which can be sent to Apartado Postal 5567, 1000 San Jose, Costa Rica.

Still another photo comes in from Vincent Bond of Carlsbad, California who got started in the hobby nearly a quarter of a century ago. He holds ham call K7NA too, but is renewing his interest in monitoring. Good to have you on board Vince and we hope you'll join us on a regular basis.



*This neat layout belongs to POP'COMM reporter Gary Barnes of Four Oaks, North Carolina and features a Kenwood R-600 as the main listening unit.*



Stewart MacKenzie of Huntington Beach, California, head man of the American Shortwave Listener's Club and vice president of the Southern California Area DX group checks in with another of his extensive logging reports. Good to have you with us again, Stewart. Incidentally, readers interested in either of the clubs in which Stewart is involved can contact him for more information at 16182 Ballard Lane, Huntington Beach, California 92649. As the name implies, the Southern California Area DX-ers are for people living in that area.

Sheryl Paszkiewicz of Manitowoc, Wisconsin reports that she checked out many of the sights of Chicago and Wisconsin on her vacation, as well as landing logs of Indonesia and the new Syrian outlet. Nice to meet you on two occasions recently Sheryl. Keep those fine reports of yours coming!

## Listening Reports

Here's what's on. All time are GMT.

**Albania** Radio Tirana noted at 0136 on 7.120 in English. ID at 0146. (Gray, MI)

**Argentina** RAE on 15.345 at 0400 in Spanish, man and woman with news, in parallel to 11.710. Also heard at 0210 in English on the same frequencies with newscast. (MacKenzie, CA)

**Armenian SSR** Radio Yerevan. 17.860 at 0253 in English with identification, address, news. 15.405 was stronger but had even more interference. Difficult. (Paszkiewicz, WI)

**Ascension Island** BBC on 7.105 in French at 0440, into English from 0445 to 0515 and then returned to French. Beamed to Africa and parallel to 9.600. Also noted on 6.005 at 0310 in English with commentary. Big Ben, "Future of Work." (MacKenzie, CA)

**Austria** Austrian Radio on 15.320 at 1235 in English with news, Austrian news in brief. (Pastrick, PA) On 9.770 with "Report From Austria" at 0130. (Miller, GA) On 5.945 at 0150 with "Report From Austria" and ID at 0147, parallel to 9.770. (Gray, MI)

**Australia** Radio Australia, on 17.795 in English at 0252, identification at 0258, parallel to 15.395 and 15.320. (Gray, MI) 0358 in French. (MacKenzie, CA) On 9.580 at 1223 with "Four Corners" program beamed to Asia and Papua New Guinea. (Pastrick, PA) 15.395 with editorial opinion at 0410. (Freeman, FL) 0400 with identification in English, news and pop music. (MacKenzie, CA) On 11.715 at 1210-1240 with talk, identification, beamed to Papua New Guinea. (Minard, OH) 15.320 at 2300 with news and ID in English, parallel 15.395. (MacKenzie, CA)

**Belgium** BRT on 9.925 at 0048 in English with program on postage stamps, parallel to 11.620. (Gray, MI)

**Canada** CKZN, relay of CBN, St. John's, Newfoundland, on 6.160 at 2100 with CBC network news in English. (Demsey, ME)

CFRX, relay of CFRB, Toronto on 6.070 at 2134 with local news. (Demsey, ME)

CHNX relaying CHNS, Halifax, Nova Scotia, 6.130 at 1315 with local news and music. (Demsey, ME)

**China** Radio Beijing on 15.520 and 11.650 at 1218 with the 19 meter band outlet much better. Commentary, music in the English broadcast to North America. (Pastrick, PA) On 11.695 at 1745 in Chinese, parallel to 9.900. On 15.600 at 0400 in parallel to 15.520 which is also heard around 2330 in Spanish. (MacKenzie, CA)

**Clandestine** La Voz del C.I.D.'s Radio Camillo Cienfuegos Service, 10.040 at 1414 to 1429, anti-Castro in Spanish, man and woman announcers. (Fravel, WV)

**Colombia** Radio Colosal/Caracol on 4.945 at 0851 in Spanish with talk, vocals, time pips, identifications, jingles, ballads, dance music. (Paszkiewicz, WI)

La Voz del Llano, 6.117, from Villavicencio heard at 0350 in Spanish with Latin pops. (MacKenzie, CA)

**Costa Rica** Radio Columbia now on 4.840, ex-4.825, Spanish vocals "Columbia" identifications, talk, news, classical music. (Paszkiewicz, WI)

**Cuba** Radio Havana Cuba noted on 15.300 at 0115 in English, stories about torture in jails, Angolan diamond smugglers. (Gray, MI)

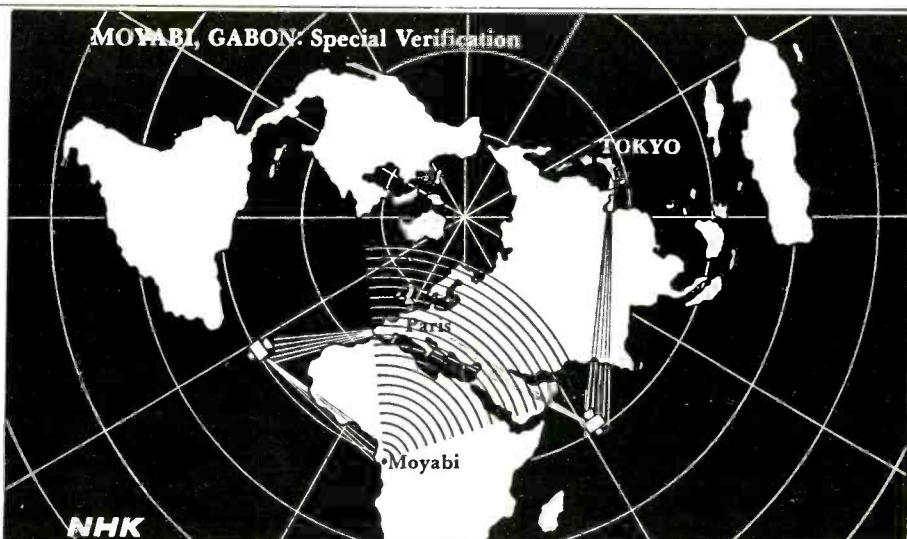

Thanks to James E. Morgan for this Radio Japan card certifying reception of the Moyabi, Gabor relay.

**Czechoslovakia** Radio Prague on 11.990 at 0106 in English with talk about Japanese Socialist Party, then "Newsview." Parallel to 7.345 and 5.930 (Gray, MI)

**Dominican Republic** Radio Clarin heard on 11.700 at 0051 with identification in Spanish. (Demsey, ME)

**East Germany** Radio Berlin International on 11.975 at 0030 with heavy interference. (Delap, NY) 9.620 at 0220 in the African service with ID "This is Radio Berlin International." (Gray, MI)

**Ecuador** HCJB on 15.115 and 11.740 at 1239, best on 15.115. English to North America with "Happiness Is." (Pastrick, PA) On 15.295 at 2245 in Japanese. (MacKenzie, CA) 15.250 in English at 0100 with "Back to the Bible." (Gray, MI) 15.155 at 0230 to 0300 with DX Party Line and new host John Beck. Parallel to 9.745. (MacKenzie, CA)

**England** BBC Waveguide program is heard Thursdays at 0030 on 7.325. (Freeman, FL) 9.915 with World Service at 0155 with "Monitor" and world news at 0200. 17.715 at 1915 in Arabic with English by Radio at 1925. Off at 1959. (MacKenzie, CA)

**Finland** Radio Finland International on 17.800 at 1212 in English to North America with environmental talk. (Pastrick, PA)

**France** Radio France International on 15.200 at 2200 with French and music. Also at 0400 on 11.700 in French. 0355 on 7.135 with English news to Africa. (Minard, OH) 15.180 and 12.000 at 0330. (Freeman, FL) 7.135 in English at 0420, parallel to 9.790. (MacKenzie, CA) Note: 15.180, probably 15.200 and possibly other frequencies are actually from the French Guiana relay station. Strength is usually a giveaway. (Editor)

**French Guiana** Radio France International relay on 15.180 at 0300 in French. Mixing with Radio Moscow in English. Into English from 0345 to 0400 sign off. (MacKenzie, CA)

**Gabon** Africa Number One in French with rock at 2126 on 11.940. No identification noted. (Demsey, ME)

**Hungary** Radio Budapest noted at 0210 in English on 9.835 with feature "Where Hungarians spend their holidays" and identification by man at 0219. (Gray, MI)

**Iceland** Voice of Iceland on 13.797 around 2100 with news or talk program in Icelandic. (Freeman, FL)

**India** All India Radio on 11.620 at 2119 in English with local music, identification, possible story. (Paszkiewicz, WI)

**Indonesia** Voice of Indonesia at 1354 on 11.790 with end of French segment, English identification following an interval signal and frequency announcement, then into Arabic with Koran. (Paszkiewicz, WI)

**Iran** Voice of the Islamic Republic of Iran heard on 15.084 at 0500 with woman and child talking in Farsi. (Bond, CA) Booming signal consistently with chanting at 1927, evenings it's noted as late as 0400. (Demsey, ME)

**Israel** Kol Israel, 9.440 at 0030 in Spanish. (Fravel, WV) At 0110 in English with discussion, parallel to 9.815 and 11.655. On 15.585 at 0405 in English with news, sports; into French at 0415 and parallel to 11.655. (MacKenzie, CA)

**Italy** RAI on 9.575 at 0104 to 0120 with news in English then music to 0120 when the English segment ends.



John Beck, new host of HCJB's "DX Party Line" program.



Bob Syphax of Long Beach, California owns this shack plus more equipment not shown in the picture.

(Fravel, WV) 11.800 at 0115 with music, slow identification by woman, parallel to 9.575. (Gray, MI) 15.385 in Italian at 1830 with interval signal, sign on and news to 1840. (MacKenzie, CA)

**Ivory Coast** Radiodiffusion Ivoirienne. Abidjan, with sign on, national anthem, man with news in French and rock from 0600 on 7.215. (Bond, CA) At 2322 to 0002 sign off with French and English music, off with the anthem. (Fravel, WV)

**Japan** Radio Japan, on 9.505 at 1705 to 1730 in English with news and current affairs. (MacKenzie, CA)

**Kenya** In a QSL letter the Voice of Kenya requests reception reports on their outlets on 4.804, 4.885, 4.915, and 4.934. Address is Box 30456, Nairobi. (Mayo, ME)

**Kuwait** Radio Kuwait noted on 11.675 with scratchy records of American soul music at 1830. Thought it was a pirate at first. (Freeman, FL) At 1830 to 2100 with En-



glish pop tunes, sign off at 2100. (Miller, GA) On 15.495 at 0335 in Arabic with Koran. (MacKenzie, CA)

**Liberia** Voice of America relay on 6.035 at 0320 in English with news and commentary. Also on 15.600 at 0330 in English with news during "Good Morning Africa." (MacKenzie, CA)

**Libya** Radio Jamahiriyah at 0440 on 11.815 in Arabic with music, man and woman announcers with comment. (MacKenzie, CA)

**Lithuanian SSR** Radio Vilnius, good on 11.860 at 2210 with news and anti-arms race talk. (Demsey, ME)

**Luxembourg** Radio Luxembourg noted on 6.090 in English at 0150 with Elton John, heavy QRM. (Gray, MI)

**Malaysia** Radio Malaysia, heard on 4.950 at 1338 with identification "This is Radio Malaysia at Kuala Lumpur," followed by commentary. (Bond, CA)

**Malta** Deutsche Welle relay station noted at 0100 in English on 9.565. (Demsey, ME)

**Mexico** Radio Universidad de Sonora at Hermosillo heard on 6.115 from 1500 to 1700 with identification at 1701. In Spanish with classical and easy listening music. (Bond, CA)

**Montserrat** Deutsche Welle Relay at 0100 sign on in English on 9.545. Parallel to 9.565. (Demsey, ME)

**Netherlands** Radio Netherlands, Lopik site, on 9.895 at 0150 in Spanish with pop music. Parallel to Bonaire outlets on 6.165 and 15.315. (MacKenzie, CA)

**Netherlands Antilles** Trans World Radio at Bonaire at 1200 on 11.815 in English to North America with "Through the Bible" program. (Pastrick, PA)

**New Zealand** External schedule for Radio New Zealand: Pacific Service at 1800 to 2100 on 11.960, 15.485; 2115 to 0330 on 17.710; 0345 to 1215 on 11.960. To Australia and Melanesia at 2115 to 0515 on 15.485, 0530 to 1215 on 9.520. Uses two 7.5 kilowatt transmitters. Reception reports to Rudi Hill, Manager, Radio New Zealand External Service, P.O. Box 2092, Wellington. Four IRCs for a QSL. (Mayo, ME) On 17.710 at 0310 in English, parallel to 15.485; 17 Megahertz outlet is discontinued at 0330. (MacKenzie, CA) On 15.485 at 0412 with soccer. (Gray, MI)

**Nicaragua** Voice of Nicaragua with English to North America on 6.015 (more frequently 6.017.5. Editor) at 0400, preceded by Spanish. (Demsey, ME) At 0400 with anti-Reagan material, five conditions for U.S. citizens wishing to enter Nicaragua. (Minard, OH) At 0400 in English with ID "The Voice of Nicaragua, official voice of the government of national reconstruction," news, propaganda to 0458. Announces 6.015 but actually on 6.017. (Moss, TX) At 0122 in English with ID at 0123. Heterodyne interference from 6.020. (Gray, MI)

**North Korea** Radio Pyongyang with commentary at 1240 on 9.745 and 9.977. (Demsey, ME) At 1200 to 1248 on 9.977 with Korean, Cuban, and Soviet news, talk on economy and "From Our Listener's Mailbag." (Minard, OH) At 1700 in English with sign on and into newscast. Also on 11.880 (MacKenzie, CA)

**Papua New Guinea** National Broadcasting Commission, Port Moresby on 4.890 at 0835 with hymns and preaching. (Bond, CA)

**Peru** Tentative Radio JSV at Huanuco on 6.060 at 0332 in Spanish. Partial identification "Radio Republica en..." (MacKenzie, CA)

**Philippines** Far East Broadcasting Company heard on 15.450 at 2310 in English with hymns and talk. (MacKenzie, CA)

**Portugal** Radio Portugal on 6.075 with sign on at 0559 with interval signal. (Minard, OH) Also heard on 6.060 at 0325 in English, Portuguese Gong interval signal, anthem and off at 0331. Parallel to 11.925. (MacKenzie, CA)

**Romania** Radio Bucharest noted on 11.830 at 0200 in English, with world news, identification at 0206. Very busy. Parallel to 9.570. (Gray, MI)

**Saipan** KYOI heard in English with rock, ID at 0632, request for reports to the Canoga Park, California address. Noted on 15.190. (Bond, CA) On 11.900 with syndicated American rock programs at 1049, English identification. (Demsey, ME) From 1111 to 1117 with rock, English and Japanese announcements. (Fravel, WV) On 15.190 at 0445 in Japanese and English. (MacKenzie, CA) On 11.900 at 1235 with pop music. "Super Rock, KYOI" ID at 1248. (Gray, MI)

KFBS on 15.110 at 1615 in English and Japanese, musical interval signal with identification, English ID by woman giving address. (MacKenzie, CA)

**Singapore** BBC Relay on 15.435 at 2300 in English with world and British news, "Letter From America." Also on 15.225 at 1800 with English and "Newsdesk" to sign off at 1830. (MacKenzie, CA)

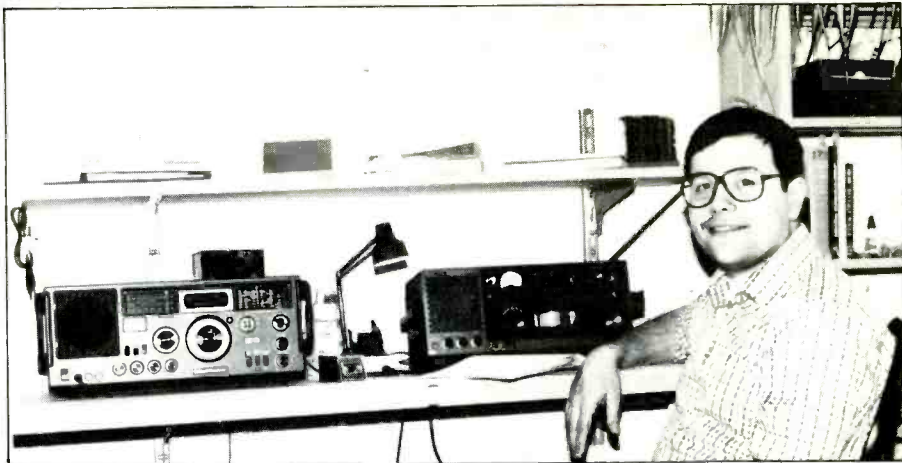

Joe Polchlopek is in the Air Force and listens from Misawa, Japan.

**Solomon Islands** Solomon Islands Broadcasting Corporation from 0807 to 0819 on 5.020 with news, music, commentary, local sports. Also at 0700 with identification on 9.545, ads, weather. (Bond, CA) On 5.020 with Pidgin at 1038. Island music, pops, time checks, Milo drink ads, country-western. Also with Radio Australia news at 1000 and Billy Graham at 1010 on a Sunday. (Paszkievicz, WI)

**South Africa** Radio RSA from 1445 to 1505 in English on 25.790. (Mayo, MA) On 6.170 at 0830. (Minard, OH) It was also heard on 5.980 at 0235 with news and discussion. (Gray, MI)

**South Korea** Radio Korea in English at 0045 on 15.575. (Delap, NY) At 1815 in English on this frequency. Also at 0240. (MacKenzie, CA) On 9.870 with English at 1655 to 1700 then into Korean. (MacKenzie, CA)

**Spain** Radio Exterior de Espana on 11.880 at 0005 with news, music, features. (Miller, GA) At 0034 with weather, Madrid Fair (do you mean fair weather in Madrid, or was Madrid holding a fair? Editor), "World of Letters," parallel to 9.630. ID at 0042. (Gray, MI) On 15.125 in Spanish at 2225 with ID, commentary, music. 17.660 at 1620 in Spanish with music. (MacKenzie, CA)

**Swaziland** Trans World Radio on 5.055 at 0420 in German with talk. (MacKenzie, CA)

**Sweden** Radio Sweden International on 15.190 at 1413 with English, interference from an unknown station. (Pastrick, PA) 9.695 at 0128 with sign on in Spanish, station ID in several languages. (Fravel, WV)

**Switzerland** Swiss Radio International on 17.765 at 1328 with English broadcast, news items, and commentary. (Pastrick, PA) On 9.885 at 0137 in English. Sign on to North America at 0145. Also in parallel to 6.135, 9.725, and 12.035. (MacKenzie, CA) On 12.037 at 2308 in French. (Minard, OH)

Red Cross Broadcasting Service on 17.785 at 1541 to 1558 with news in English of Red Cross activities, into French at 1559. (Fravel, WV) Active only on last Sunday of each month. (Editor)

**Syria** Syrian Arab Republic Broadcasting Service heard on 12.085 as early as 1355 and as late as 2317 in Arabic with talks, instrumental and vocal music, Koran, American instrumental music, identifications, dramas, and news at a quarter past the hour. (Paszkievicz, WI)

**Tahiti** Radio Tahiti, 15.170 at 0420 with discussion, island music. Parallel to 11.825. (Gray, MI) 15.170 at 0445 with Polynesian music. (MacKenzie, CA)

**Taiwan** Voice of Free China, at 0653 on 5.990 (5.985? Editor) with Chinese music, woman announcer. (Minard, OH)

**Turkey** The Voice of Turkey in English from 0300 to 0350 on 11.755 to North America. Heard at the same hour to Southeast Asia on 17.815. Best heard in the General Service at 0400 on 15.220. (Bond, CA) 11.755 at 0300 in English with news items and "Turkish Press." (Gray, MI) 15.220 at 0445 in Turkish with Turkish music. (MacKenzie, CA)

**Ukraine** SSR Radio Kiev on 11.720 at 0225 with "Ukraine Today," 40th anniversary of second front in World War II. (Gray, MI)

**United Arab Emirates** UAE Radio, Dubai on 15.300 and 15.320 (better heard) at 1615 with news in English. (Demsey, ME) On 15.435 at 0350 in English with news, into French at 0354. (MacKenzie, CA)

**United States** Voice of America, 9.455 with "Music USA" at 0036 to 0100. (Fravel, WV)



Another ham who likes shortwave listening is Vince Bond, K7NA of Carlsbad, CA.

**AFRTS** 15.425 at 1612 with network news. (Minard, OH) On 17.765 at 0000 with features feed. (Freeman, FL) Has been heard on 6.030, 9.700, 11.800, 12.030, 17.770, 15.430, and 9.430. (Lytthgoe, IN)

**USSR** Radio Moscow with home service via Magadan on 9.500 at 1725 in Russian with folk music. World Service via Petropavlovsk on 9.570 at 1729 with commentary and news. In parallel to 9.705. Via Krasnodar on 15.550 at 0420 in Portuguese. World Service on 17.850 at 0355, parallel to 17.860 and at 0435 on 15.470. (MacKenzie, CA)

**Vanuatu** Radio Vanuatu, 7.260 at 0942 in language with island music, choral music, religion, frequency announcement, national anthem and off at 1002. 3.945 was stronger but had more static. (Paszkievicz, WI)

**Vatican** Vatican Radio on 11.810 with news in English to Africa from 1545 to 1600. (MacKenzie, CA) On 11.845 at 0057 in English, parallel to 9.605. (Gray, MI)

**Venezuela** Time station YVTO with blips and identification in Spanish at 0325 on 6.100. (Demsey, ME) Heard best during 0000-0700 time slot. (Minard, OH)

Our sincere thanks to the following: Vincent Bond, Carlsbad, CA; George Delap, North Lindenhurst, NY; Marshall Moss, Brenham, TX; David Demsey, Augusta ME; Stan Mayo, Portland, ME; Robert Pastrick, Baden, PA; R.P. Lythgoe, Evansville, IN; J. Speed Gray, Grand Rapids, MI; Mary K. Minard, Parma, OH; Rick Freeman, Orlando, FL; Larry R. Fravel, Clarksburg, WV; John Miller, Thomasville, GA; Sheryl Paszkievicz, Manitowoc, WI; Stewart MacKenzie, Huntington Beach, CA.

Remember we are looking forward to your reports, your letters, comments, questions, shack photos, schedules, good high contrast copies of your more interesting QSLs—in fact, anything you think might be of interest to other readers. Let's hear from you next month. Til then, good listening!

# WE BOUGHT ALL THAT SONY HAD!



**GOING . . . GOING . . . GOING . . .**

NOW is the time to buy; they are almost gone. Sony doesn't have any more, and when our supply is exhausted that's it. Buy one now and stash it away for Christmas.

**FINAL CLOSEOUT!**

Reg. \$179.95  
Now only **\$96.50**  
plus \$3.00 UPS



**ONE YEAR WARRANTY**

## SONY ICF-6500W

"The 6500W performs on a par with models in the \$200-300 price range" (World Radio TV Handbook)

- Digital LCD display for accuracy
- Dual Conversion Superheterodyne
- BFO for SSB/CW • 1 uV Sensitivity
- AFC for FM • AC/DC power

## EXTRA SPECIAL OFFER

NEWSSTAND PRICE: \$23.00  
SUBSCRIPTION PRICE: \$14.00



Buy a Sony ICF-6500W and receive a year's subscription to Popular Communications magazine absolutely free!! This offer is good only until we sell out.

The new Sony ICF-2002 is here! From one of America's largest Sony SWL dealers.

Reg. \$249.95  
INTRODUCTORY SPECIAL  
**\$224.95**  
Plus \$3.00 UPS



**AVAILABLE NOW!**

## MAKE WAY FOR THE NEW LEADER IN SW!

After selling over 1,000 ICF-2001's we didn't think Sony could top this performer, but they did!

### FEATURES

Ten memory channels • 12/24 hour quartz clock • PLL tuning for drift-free performance • Dual conversion Superheterodyne for high sensitivity • SSB/CW

### SPECIFICATIONS

150 kHz-30 MHz AM, 76-108 MHz FM • 1 uV sensitivity @ 6 dB S/N @ 10 MHz • 72 dB @ 10 MHz image ratio • 3 kHz @ -6 dB

## SONY AN1 ACTIVE ANTENNA



- 100KHZ-30MHz
- Remote 59 inch Telescoping Whip
- Battery or Optional AC Powered

**\$7995**  
+ \$3.00 UPS

When you're stuck in an apartment with no other choice, this may just be the answer. The unique design offers numerous mounting & hook up options. You will be surprised how well it works.

SONY		PANASONIC		ICOM		PUBLICATIONS	
AN1	\$ 79.95 + (\$ 3 UPS)	RF9	\$ 87.00 + (\$2 UPS)	ICR71	\$739.00 (\$9 UPS)	(\$2 UPS 1st book, ea additional book add 50¢ UPS)	
ICR4800	69.95 (\$ 2 UPS)	RFB50	129.00 (\$2 UPS)	BEARCAT		World Radio TV Handbook, 1984	
ICF6800W	549.95 (\$10 UPS)	RFB300	219.00 (\$3 UPS)	DX1000	\$529.00 (\$9 UPS)	Edition	
AC9W	12.00 (\$ 2 UPS)	RFB600	499.95 (\$9 UPS)	AMECO		SWL Manual of Non Broadcast Stations	
AC160W	14.00 (\$ 2 UPS)	RF799	229.95 (\$3 UPS)	PLF2 Preamp	\$57.95 (\$3 UPS)	How to Tune the Secret Shortwave Spectrum	
DCC127	29.50 (\$ 2 UPS)	RF1405	69.95 (\$3 UPS)	EAVESDROPPER		The Complete Short Wave Listeners Handbook	
AC120	11.00 (\$ 2 UPS)	RF3100	279.00 (\$5 UPS)	SWL Dipole	\$59.95 (\$3 UPS)	Short Wave Listeners Antenna Handbook	
				MFJ		Whites Radio Log	
				1020	\$79.95 (\$2 UPS)	9.95	
				752B	89.95 (\$3 UPS)	9.95	
				304	79.95 (\$2 UPS)	4.95	
				308	99.95 (\$2 UPS)		

Shipping charges in parenthesis are for continental U.S. only. International orders write for pro forma invoice. Illinois residents please add 7% sales tax.



**SPECTRONICS, INC.**  
1009 GARFIELD ST. OAK PARK, IL. 60304

Phone:  
**(312) 848-6777**





# DON'T LET THE ELECTRONICS REVOLUTION PASS YOU BY BECOME A CHARTER SUBSCRIBER TO

## **MODERN ELECTRONICS**

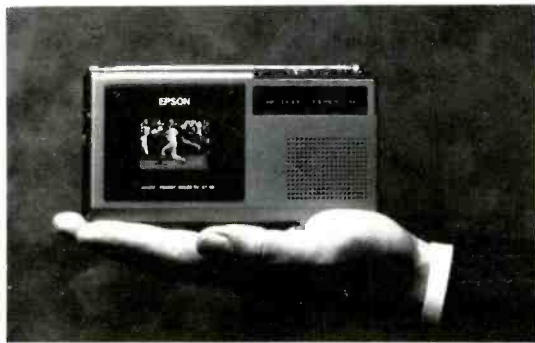

Now you can reach out every month and learn about the latest innovations in consumer electronics and personal computers—what's new, how products and circuits work, and what leading authorities think of them.

**\*Stereo \*Video \*Home & Car Electronics  
\*Test Instruments \*Circuitry & Devices \*Servicing  
\*Personal Computers \*Communications \*Construction Projects**

In every issue, authors lucidly explain how exciting, new electronics ideas are applied . . . issue forthright buying counsel . . . present complete plans to build electronic devices to enhance products, even unique ones that are not yet being sold in the marketplace.

Feature articles, tutorials, and construction projects are the hallmarks of MODERN ELECTRONICS, the new monthly magazine for electronics and computer enthusiasts. Covering the entire spectrum of these fields, you'll gather insights in every important area to help you make buying decisions for work and play purposes . . . improve performance of your present equipment . . . increase your electronics competence . . . and add to your practical and intellectual knowledge of electronics and computers.

To be sure you get this valuable information delivered to you regularly, and share the experiences of our writers and editors—Forrest Mims, Len Feldman, Stan Prentis, Charles Rubenstein, Glenn Hauser, and many others—you can subscribe to MODERN ELECTRONICS today. As a Charter Subscriber, you'll save 45% off the newsstand price when you buy a one-year subscription for only \$12.97. Or save 51% when you subscribe for two years at \$22.97.

Acting now you won't miss any of our exciting upcoming features, such as the "Circuit Designing From Scratch" series starting in November that will show you, step by step, how to create your own circuits to perform tasks you dream up; "Solving the Extension Speaker Impedance Matching Puzzle," "Delayed-Action Auto Theft Deterrent" Project, and more.

Just fill out the coupon and mail with your check, money order, or credit card information (Visa or MasterCard) to enter your Charter Subscription. Do it today to ensure earliest delivery!

**MODERN ELECTRONICS** 76 North Broadway, Hicksville, NY 11801

Please send me Modern Electronics for  2 Years  1 Year

Name \_\_\_\_\_

Street \_\_\_\_\_

City \_\_\_\_\_

State \_\_\_\_\_ Zip \_\_\_\_\_

Charge My Order To: Payment Enclosed \$ \_\_\_\_\_ 2 Years (24 issues) . . . . . \$22.97

MasterCard My account number is: 1 Year (12 issues) . . . . . \$12.97

VISA \_\_\_\_\_

### Beaming In (from page 4)

### Speaking Of Snooping Around

Scanner owners, as well as those who like to listen to the more exotic things that can be tuned on a communications receiver (like federal and spy stations) sometimes comment, "If they're listening to you, then listen back at them." This is an interesting comment, but I wonder if anybody knows the extent of which *they* are listening to you.

According to reports filed with Congress and the judiciary, undercover electronic surveillance by the government, both in criminal investigations and foreign intelligence collecting, has sharply increased within the past few years. For example, in 1979 there were less than 100 wiretaps authorized by judges for federal agents. Last year there were nearly 500 such authorized intercepts to personal and presumably private landline communications.

As has been pointed out previously in these pages, laws governing communication privacy are probably best taken with a grain of salt, as are the definitions of what constitutes a criminal or foreign intelligence investigation. Maybe the public has already taken too many grains of salt—and too much salt isn't especially healthy. In the meantime, like the man said, if they're listening to you, listen back. Enjoy! **PC**

### Coming Soon In POPULAR COMMUNICATIONS

**POPULAR COMMUNICATIONS** OCTOBER 1984 \$1.95  
12.00 CANADIAN



- The "Unknown Mysterious Station"—World's Pioneer Pirate
- Shortwave Portable Receiver Roundup
- HF Single Letter Beacons The Search Goes On
- Diffusoras De Amazonas
- Scanning Taxi Frequencies

# COMMUNICATIONS SHOP

**Advertising Rates:** Non-commercial ads are 30 cents per word including abbreviations and addresses; minimum charge \$6.00 per issue. Ads from firms offering commercial products or services are \$1.00 per word; minimum charge \$20.00 per issue. Leading key words set in all caps at no additional charge. All classified ads must be prepaid in full at time of insertion; a 5% discount is offered for prepaid 6 time insertions. All ads must be typewritten double spaced.

**Approval:** All ad copy is subject to Publisher's approval and may be modified to eliminate references to equipment and practices which are either illegal or otherwise not within the spirit or coverage scope of the magazine.

**Closing Date:** The 10th day in the third month preceding date of publication. Because the advertisers and equipment contained in Communications Shop have not been investigated, the Publisher of Popular Communications cannot vouch for the merchandise listed therein. Direct all correspondence and ad copy to: PC Communications Shop, 76 N. Broadway, Hicksville, NY 11801.

**GREAT TRAIN SOUNDS** in "stereo." Enjoy a 60 minute cassette recording of Amtrak, SP Commute & Freight train sounds in and around the San Jose, CA peninsula area. Series I, \$9.95 ppd. Fred DeLap, P.O. Box 700065, San Jose, CA 95170-0065.

**ALDEN WEATHER FAX** recorder. Use with any communications receiver. Produces superb weather maps and satellite pictures. Only six months old. Sacrifice: \$500. Contact Ron c/o Lopez High School, 1221 Ash Ave., Arroyo Grande, CA 93420. Phone: (805) 489-1351 ext. 437 (before 3 p.m.).

**SE II R7A WITH AM FILTER** \$1050. ICOM 740 with built-in AC P.S. \$650. Both excellent. David Schwartz, 1183 Southeast St., Amherst, Mass 01002.

**"FANTASTIC DISCOUNTS"** ICR-71A \$689.50, Kenwood R-2000 \$499.50, SONY 2002 \$219.50, HX-1000 \$249.50, CR-2021 \$159.50, in stock!! MX-5000 \$388.50, Bearcat, CW/RTTY, MFJ, Panasonic, 25 page picture catalog \$1.00 (refundable). Galaxy Electronics, Box-1202, 67 Eber Ave., Akron, Ohio 44309 (216-376-2402) 9-5 pm EST.

**UNDERGROUND COMPUTER** bulletin boards. Get hundreds of modern phone numbers in PLUMB, the BBS newsletter. One year: \$26.50, sample: \$2. PLUMB, Box 300-P, Harrods Creek, KY 40027.

**BOOK SALE:** Big Discounts on new, used Survival Titles. Free, Confidential Catalog. Richmar, Dept. P11, Box 14956, Albuquerque, NM 87191.

**DXERS STONEWARE COFFEE MUG:** As advertised on Radio Earth (multicolored emblem). Useful collector's item—great Christmas gift! Just \$6.00 post-paid in USA (\$8.00 overseas) (s.a.s.e. for free info). Collectibles By Marion, P.O. Box 60704, Houston, Texas 77205.

**CHESS BY AMATEUR RADIO.** License unnecessary. Information: K2VJ, Box 682A, Cologne, NJ 08213.

**RECEIVERS FOR SALE:** (13) R1121/TRC-87 \$200.00 ea., (4) R392/GRC-19 \$175.00 ea., (4) R278/GRC-27 \$75.00 ea., (3) R482/URR-35 \$25.00 ea., (3) RT70/AM 65 \$15.00 ea. Have parts, modules, and manuals for the above call 419-726-2249.

## JR. TROOPER CAMOUFLAGE

*Jungle fatigues for your little soldier.*

Just like the Army's Battle Dress Utilities - 4 pocket top, 5 pocket pants - reinforced seat, knees & elbows. Easy care 50/50 Nylon Cotton Twill. Size 8-16.

BJF71, Trooper Top \$21.95

BJF72, Trooper Pants \$21.95

Send FREE 96 page catalogue loaded with survival, hunting, camping & military gear.

Send check or Money Order to:



**Brigade Quartermasters, Ltd.**

266 Roswell Street, Dept. 70K, Marietta, GA 30060  
**Money Back Guarantee**

Please send all reader inquiries directly.

## TUBES—2,000 TYPES DISCOUNT PRICES!



New 20-pg. wholesale catalog for the radio collector/hobbyist. Antique, hard-to-find and modern tubes. Also transformers, capacitors and parts for tube equipment, and books, etc.

**Antique Electronic Supply**  
1725 W. University  
Tempe, AZ 85281

CIRCLE 73 ON READER SERVICE CARD

**SIDEBAND OPERATORS!** Join the oldest/largest network of 27 MHz SSB operators. Now more than 100,000 strong! Send self-addressed stamped long (#10) envelope for FREE details and application (no obligation). SSB Network, P.O. Box 908, Smithtown, NY 11787.

## Just in time for Christmas! The Computerized Weather Station Perfect for any season!

This easy-to-assemble ID-4001 personal weather computer gives you up-to-the minute meteorological readouts including time/date, indoor and outdoor (F or C) temperatures, wind speed and direction, and barometric pressure. Past weather data can be recalled with the touch of a button. Kit priced at \$399.95. Send for complete details today using the coupon below. Visa and MasterCard orders call TOLL-FREE: 1-800-253-0570.



**Heathkit**  
Health  
Company

## FREE COLORFUL CATALOG

Please send me my FREE Heathkit Catalog featuring the ID-4001 Computerized Weather Station and many other quality electronic kits.

Name \_\_\_\_\_

Address \_\_\_\_\_ Apt. \_\_\_\_\_

City \_\_\_\_\_

State \_\_\_\_\_ Zip \_\_\_\_\_

MAIL TO: Heath Company, Dept. 336-232  
CL-767 Benton Harbor, MI 49022

CIRCLE 59 ON READER SERVICE CARD

November 1984 / POPULAR COMMUNICATIONS / 75



**\$1.25**

That's all it takes to get a copy of the USA-CA Record Book delivered to your door. Order one or two today and start collecting counties for one of amateur radio's most prized awards, USA-CA.

**CQ Magazine**  
76 North Broadway  
Hicksville, New York 11801



## UNSCRAMBLERS

FOR POLICE, FIRE & MEDICAL CODES  
SATISFACTION GUARANTEED  
SEND FOR COMPLETE INFORMATION  
**DNE, INC. — RT. 7, BOX 257C**  
**HOT SPRINGS, ARKANSAS 71901**  
**501-623-6027**

Please send all reader inquiries directly.

## Shortwave Receivers, Antennas

ICOM - KENWOOD - YAESU Etc.

Call 212-925-7000

Open 7 days a week, Mon.-Fri. 9am-6pm,  
Thurs. until 8pm, Sat. & Sun. 10am-5pm

## Barry Electronics

512 Broadway • New York, NY 10012  
Sales & Service Ham & Commercial Radio  
For 35 Years

Please send all reader inquiries directly.

## CB MODIFICATIONS

Increase channels, range, privacy! We specialize in frequency expanders, speech processors, FM converters, PLL & slider tricks, how-to books, plans, kits. Expert mail-in repairs & conversions. 16-page catalog \$2

**CBC INTERNATIONAL, P.O. BOX 31500PC,**  
**PHOENIX, AZ 85046 (602) 996-8700**

Please send all reader inquiries directly.



## 7 MILLION TUBES FREE CATALOG

Includes all Current, Obsolete, Antique, Hard-To-Find Receiving, Broadcast, Industrial, Radio/TV types. **LOWEST PRICES**, Major Brands, In Stock.

**UNITY Electronics Dept. P.C.**  
**P.O. Box 213, Elizabeth, NJ 07206**

CIRCLE 112 ON READER SERVICE CARD



## AIRCRAFT - AIRPORT CAR RADIO!



"LISTEN IN" TO AIRCRAFT - AIRPORTS - WORLDWIDE!  
118-136 Mhz. Works in cars or with ALL home radios - NO HOOKUPS NEEDED! Self powered - Works everywhere  
Complete \$29.95 (plus \$2.00 p&g) Call 1-308-236-5333  
ANYTIME with credit cards or order by mail. Same day shipment. Free information

**WESTERN RADIO DEPT.-C. KEARNEY, NEBR. 68847**

CIRCLE 31 ON READER SERVICE CARD

## RADIO WORLD

Order Toll Free: 1-800-448-9338

Your Source For Shortwave Receivers, Antennas, RTTY Converters, Computers, Interfaces And Scanners.

Kenwood • Yaesu • Icom • Collins • Drake • Robot • Kantronics • AEA • Info-Tech • MFJ • Microlog • Grove • Commodore • Bearcat • Panasonic • Regency

## HAM RADIO WORLD

Oneida County Airport • Terminal Building  
Oriskany, New York 13424  
1-315-736-0184

CIRCLE 19 ON READER SERVICE CARD

## FREE

### Attention Shortwave Listeners

Finally, a professional newsletter for the serious listener. For free sample copy send 3¢ US coins or stamps (70¢ Canadian) or 7 IRC's overseas to cover postage and handling to:

**Miller Publishing**  
**424 West Jefferson St., Suite B**  
**Media, PA 19063**

Please send all reader inquiries directly.

"RAIL-SCAN" by Tom Kneitel. New scanner frequency directory! Largest & most comprehensive railroad industry communications directory ever! 4,200 frequencies, 863 major RR's, short lines, narrow gauge, government, miniature, movie, museum, scenic, industrial traction, mass transit lines, private car owners, RR police, car/locomotive builders & service companies, regulatory agencies, accident/emergency channels, RR addresses, trackage data, lots more. Only \$7.95 (add \$1 for 1st Class Mail). Order now or ask for free info. CRB Research, Box 56-PC, Commack, NY 11725.

**NEW! TOP SECRET REGISTRY OF U.S. GOV'T FREQUENCIES** by Tom Kneitel. Yes, it's finally here! The NEW 5th Edition is now 168 pages BIG in large 8 1/2" x 11" format (same page size as POP'COMM). Latest federal scanner frequency listings for FBI, FCC, Border Patrol, ATF, Immigration, Secret Service, CIA, Customs, Coast Guard, Armed Forces, and much more. Tens of thousands of call signs, frequencies, locations. The ultimate scanner directory also reveals many HF listings plus complete historic roster of all federal land stations authorized in 1923 (60 years ago!). New 5th Edition is \$14.95 postpaid by Book Rate Mail, or add \$2 if First Class Mailing wanted. Order your copy now! CRB Research, P.O. Box 56, Commack, NY 11725.

**WANTED: CASH PAID FOR USED SPEED RADAR EQUIPMENT.** Write or call: Brian R. Esterman, 735 Laramie Ave., Wilmette, Illinois 60091, (312) 251-8901.

**MUST SELL.** Midex 55 burglar alarm system in excellent condition. Works great. \$200.00 wanted. Send SASE or call (213) 599-8389. Mark Harvey, 2010 Cedar St., Apt. C, Long Beach, CA 90806.

**CLANDESTINE CONFIDENTIAL** keeps you up to date on the latest in clandestine broadcasting. 6 issues per year \$10 in the U.S., \$13 foreign. G.L. Dexter, RR4 Box 110, Lake Geneva, WI 53147.

**JOIN A RADIO listening club.** Complete information on major North American clubs for 25¢ and SASE. Association of North American Radio Clubs, 1500 Bunbury Drive, Whittier, CA 90601.

**CB RADIO MODIFICATIONS!** Increase channels, range, privacy. Conversion hardware, books, plans, kits, repairs. Catalog \$2. CBCI, Box 31500PC, Phoenix, AZ 85046.

**FREE CATALOG** featuring scanner accessories, carrier/subcarrier detectors, voice scramblers, unusual kits. Capri Electronics, Route 1-GC, Canon, GA 30520 (404) 376-3712.

**NORTH AMERICAN RADIO-TV STATION GUIDE** by Vane Jones. Brand new 15th Edition! Thick 226-page book listing all US/Canadian/Mexican/West Indies AM/FM/TV broadcasters according to location/frequency/callsign, plus TV network affiliation, AM station day/night power, schedule data, etc. Painstakingly complete, accurate, up-to-date. The ultimate broadcast station directory. Only \$9.95 (plus \$1 postage) from CRB Research, P.O. Box 56, Commack, NY 11725.

**WANTED: OLD RCA, CUNNINGHAM, Western Electric, Genalex, tubes, speakers, amplifiers.** McIntosh, Marantz. 713-728-4343. Maury Corb, 11122 Atwell, Houston, Texas 77096.

**S.W.L. REPORT FORMS** designated for maximum information your listening post. Give real meaning your D.X. reports. Details 2 IRC. Rout.3/137 Champion St., Christchurch, New Zealand.

**LOWEST PRICES ON BEARCAT, REGENCY SCANNERS:** Trade-ins, Used Scanners at savings, Descramblers, Accessories. Free catalog! Spotlight Communications, Box 3047, Greenville, NC 27836-3047.

**POLICE & FIRE SCANNERS.** Special—Regency D-310, 30 Channel Digital Scanner \$129.99 plus \$4.00 shipping. See Our Full-Page Ad in This Issue for Complete Description. Free Catalog Available. **SCANNER WORLD, USA**, 10 New Scotland Ave., Albany, NY 12208, phone 518-436-9606.

**SOLAR ELECTRICITY.** Photovoltaic systems for remote power or emergency backup. Generate electricity by sunlight. Send \$1.00 (refundable with order) to Springhouse Energy Systems, 418 Washington Trust Building, Washington, PA 15301 (412) 225-8685.

# AD INDEX

All Electronics	53
Antique Elec. Supply	75
Auburn-Wolfe Pub. Co.	18
Barker & Williamson	5
Barry Electronics	76
Brigade Quatermasters Ltd.	75
Butternut Electronics Co	69
CBC International	76
CRB Research	59
Communications Elect.	2, 7
Computer Trader	65
ConSol	24
Contact East	45
DNE Inc.	76
Delaware Amateur Supply	24
EGE, Inc.	45
Electronic Equipt Bank . . . Cov. II,	42
Gilfer Shortwave	23
Ham Shack	28
Hamtronics, Inc.	25
Heath Co.	75
Hustler, Inc.	4
Grove Enterprises	39
ICOM America, Inc.	Cov. IV
Kenwood	Cov. II
Litsche, N.E.	55
MFJ Enterprises, Inc.	43
Madison Electronics	65
Martin Engineering	65
Meshna Inc.	12
Metz Communication Corp.	53
Microlog Corp.	5
Missouri Radio Center	63
Miller Publishing	76
PopComm Book Shop	59
Radio West	49
Radio World	76
Research Electronics	53
Scanner World, USA	1
Spartan Supply Co. Inc.	69
Spectronics, Inc.	73
Unique Communications	65
Unity Electronics	76
Universal Electronics	65
Universal Security	24
Universal Shortwave Radio	5, 53
U.S. Calvary Store, Inc.	49
VanValzah Co.	51
Western Radio	76
Worldwide Publications	55

# SWL HEADQUARTERS

NATIONS LEADING SHORTWAVE EQUIPMENT SUPPLIER

## ICOM R71A SPECIAL

EEB IS ICOM'S #1 RECEIVER DEALER AND THERE'S GOOD REASON

- **EEB** does 100% QC, including 24 hour bench test and complete alignment.
- **EEB** offers more options and modifications to tailor your receiver to your needs.
- **EEB's** skilled technicians know the R71A inside and out, and offer many optional improvements.
- **EEB** doubles your warranty: 90 days ICOM / 90 days **EEB**, so you are covered a full 6 months!
- **EEB** is an authorized ICOM Service center. We take better care of you.



- 100KHz—30MHz
  - Keyboard Entry
  - 32 Memories
  - Memory Back-Up
  - Scanning Frequencies & Memories
  - Passband & Notch Tuning
  - Wide Dynamic Range
- AS LOW AS **\$659**  
list \$799
- Add \$7.00 UPS

### OPTIONS

CK-70	12 Volt DC Kit	\$9.95
CR-64	High Stability Osc.	\$56.00
EX-310	Voice Synthesizer	\$39.95
EX-257	FM unit (10M Ham)	\$38.00
FL-32	CW filter, 500Hz 9MHz	\$59.50
FL-44	2.4KHz 455KHz SSB Crystal Filter	\$159.00
FL63	CW filter 250Hz 9MHz	\$48.50
RC-11	Remote Control	\$59.95

**INSTALLATION** . . . options can be installed by a skilled user/owner. **EEB** will do it for you!

- 1-3 options . . . . . \$ 35
- 4 and up . . . . . \$ 45

### EEB OPTIONS INSTALLED

- **Mechanical 2.4KHz filter**—replaces stock ceramic filter—improves SSB, ECSS, AM narrow selectivity. . . . . \$ 95
  - **Front end upgrade**—improves dynamic range (plus), pre-amp enable below 1600KHz . . . . . \$ 35
  - **4KHz filter** replaces stock 6KHz wide filter. Improves AM selectivity. . . . . \$ 50
- ICOM ICR71A with full **EEB** service . . . . . \$699  
Factory and extended warranty, tested and aligned
- ICOM ICR71A with full factory warranty but without **EEB's** extra service/no installed options . . . . . \$659

## \*KENWOOD R-2000



- 100 KHz to 30 MHz
  - All mode AM-CW-SSB-FM
  - 10 memories (memorizes mode)
  - Memory backup
  - Memory scan
  - Programmable band scan
  - 24-hour clock-timer
  - VC-10 VHF converter 118-174 MHz \$139
- R-2000 \$599.95 . . . . . SALE \$499  
R-1000 \$499.95 . . . . . SALE \$429  
R-600 \$399.95 . . . . . SALE \$329  
ADD \$6.50 UPS

**Sale**  
**\$499**  
List \$599.95

## \* YAESU FRG-7700



- 150 KHz-30MHz
  - All mode AM-CW-SSB-FM
  - Digital frequency and clock
- SPECIAL PACKAGE DEAL**  
7700-MU7700  
FRA-7700  
499<sup>95</sup>
- Options:**
- FRA-7700 active antenna . . . . . \$49
  - MU-7700 12 channel memory . . . . . \$139
  - FRT-7700 antenna tuner . . . . . \$59
  - FF-5 VLF low pass filter . . . . . \$20
  - DC-7700 12 VDC kit . . . . . \$8
  - FRV-7700 VHF converter . . . . . \$109
  - ADD \$6.50 UPS

**Sale** **\$399**

## TOSHIBA RP-F11

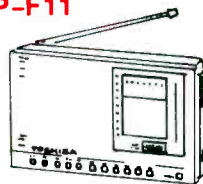

- NEW**  
**\$99.95**  
(Add \$4.00 UPS)
- AM, FM (76-108MHz). All major SW bands. S-Meter. (Sony ICF-7600A has a real competitor in the RP-F11—same range, better sensitivity, lower cost.)  
(More details 1984 WRTVH, page 585)

## \* PANASONIC RF-B600



- Sale**  
**\$429**  
List \$595  
(\$6.00 UPS)
- 1.6 to 30 MHz, FM/LW/MW/SW
  - Micro computer multi-tuning system
  - 9 memory stations, scan
  - Slow/Fast rotary tuning
  - 10 key direct access tuning
  - Universal voltage
- RF-9 \$99.95 . . . . . SALE \$89.00  
RF-085 . . . . . CLOSE OUT \$49.95  
RF-B300 \$249.95 . . . . . SALE \$209
- ADD \$4.00 UPS

## \* UNIDEN CR 2021

**Sale**  
**\$99.95**  
List \$229.00



- \*Uniden's Worldwide Radio is among the finest multi-purpose available anywhere. It features a triple conversion receiver that precisely locates weak, distant signals automatically. It locks the precise stations in for perfect reception.
- 12 Channel Programmable Memory
  - Dual Power AC or DC
  - Micro-processor
  - Triple Conversion Receiver
  - Keyboard Channel Selector
  - LCD Readout
  - Preset Channels
- \$4.00 UPS.

## \* SONY ICF-2002



Introductory  
Special  
**\$229**  
List \$249.95

- Features:** Ten memory channels • 12/24 hour quartz clock/PLL tuning for drift-free performance • Dual conversion Super-heterodyne for high sensitivity • SSB/CW
- ICR-4800 \$99.95 . . . . . SALE \$79.95  
ICF-6500W \$199.95 . . . . . SALE \$99.95  
ICF-7600A \$169.95 . . . . . SALE \$139  
AN-1 \$79.95 (AC Adapt \$9.95)  
ADD \$4.00 UPS

## NEW From SONY AN-1 WORLD BAND ANTENNA

- Telescoping 59" stainless steel whip
  - 100KHz to 30MHz
  - Antenna coupler and special induction module supplied
  - Control module features attenuator, frequency selector, and battery power
- EEB tests indicate AN-1 to work as well as other antennas costing twice as much and less susceptible to overload from strong signals.

**\$79.95**  
Optional AC adapter AC-12 . . . . . \$18.39  
EEB AC Adaptor . . . . . 9.95  
Add \$5.50 UPS.

## FREE CATALOG

Send self-addressed, stamped envelope.



- We ship worldwide
- Shipping charges not included
- Prices & specifications subject to change without notice
- Canadian Orders: VISA, MC or POSTAL MAIL ORDERS ONLY!



10 Miles West of Washington, D.C.  
Sorry—No COD's  
10-5 Tues. Wed. Fri.  
10-9 Thursday  
10-4 Saturday  
Closed Sunday and Monday

**Electronic Equipment Bank**  
516 Mill Street, N.E  
Vienna, Virginia 22180  
**Order Toll Free 800-368-3270**  
Virginia 703-938-3350





# ICOM IC-R71A

## The Best Just Got Better



IC-GC4  
World Clock

ICOM introduces the IC-R71A 100kHz to 30MHz superior-grade general coverage receiver with innovative features including keyboard frequency entry and wireless remote control (optional).

This easy-to-use and versatile receiver is ideal for anyone wanting to listen in to worldwide communications. Demanding no previous shortwave receiver experience, the IC-R71A will accommodate an SWL (shortwave listener), Ham (amateur radio operator), maritime operator or commercial operator.

With 32 programmable memory channels, SSB/AM/RTTY/CW/FM (optional), dual VFO's, scanning, selectable AGC and noise blanker, the IC-R71A's versatility is unmatched by any other commercial grade unit in its price range.

### Superior Receiver Performance.

Utilizing ICOM's DFM (Direct Feed Mixer), the IC-R71A is virtually immune to interference from strong adjacent signals, and has a 100dB dynamic range.

Passband tuning, a deep IF notch filter, adjustable AGC (Automatic Gain Control) and noise blanker provide easy-to-adjust clear reception, even in the presence of strong interference or high noise levels. A preamplifier allows improved reception of weak signals.

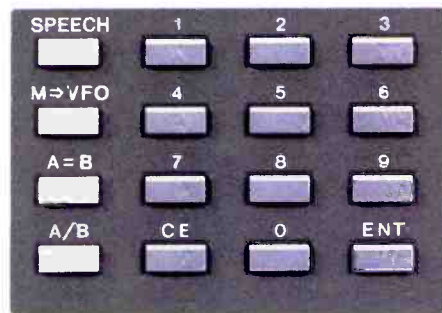

**Keyboard Entry.** ICOM introduces a unique feature to shortwave receivers... direct keyboard entry for simplified operation. Precise frequencies can be selected by

pushing the digit keys in sequence of frequency. The frequency will be automatically entered without changing the main tuning control. Memory channels may be called up by pressing the VFO/M (memory) switch, then keying in the memory channel number from 1 to 32.

**VFO's/Memories.** A quartz-locked rock solid synthesized tuning system provides superb stability. Three tuning rates are provided: 10Hz / 50Hz / 1KHz.

**32 Tunable Memories.** Thirty-two tunable memories, more than any other general coverage receiver on the market, offer instant recall of your favorite frequency. Each memory stores frequency, VFO and operating mode, and is backed by an internal lithium memory backup battery to maintain the memories for up to five years.

**Options.** FM, synthesized voice frequency readout (activated by SPEECH button), RC11 wireless remote controller, IC-CK70 DC adapter for 12 volt operation, MB12 mobile mounting bracket, two CW filters FL32 — 500Hz, and FL63 — 250Hz, and high-grade 455kHz crystal filter FL44A.



IC-RC11  
Infrared  
Remote

CIRCLE 67 ON READER SERVICE CARD

ICOM America, Inc., 2112-1 16th Ave NE, Bellevue, WA 98004 (206)454-8155 / 3331 Towerwood Drive, Suite 307, Dallas, TX 75234 (214)620-2780  
All stated specifications are approximate and subject to change without notice or obligation. All ICOM radios significantly exceed FCC regulations limiting spurious emissions. R71A284

 **ICOM**  
The World System